

Workshop Manual

944

DR. ING. h. c. F. PORSCHE Aktiengesellschaft

SUPPLEMENT TO REPAIR MANUAL 944

(V)

Instruction Sheet on Extending 944 Repair Manual in Four Volumes

Survey of Repair Manual Volumes :

- Volume I = Engine
- Volume II = Transmission
- Volume III = Running Gear, Heater, Air Conditioner, Body
- Volume IV = Electrical System

Please insert sheets in various volumes of the repair manual as specified below:

1. File pages 40 - 01 to 48 - 17, 50 - 01 to 66 - 8 and 87 - 1 to 87 - 22 from old Volume I in new Volume III (Running Gear, Heater, Air Conditioner, Body).
 2. File pages 90 - 1 to 97 - 69 from old Volume I in new Volume IV (Electrical System).
-

This Workshop Manual describes all of the important operations for which special instructions are required to assure proper completion. This manual is essential for shop foremen and mechanics, who need this information to keep the vehicles in safe operating condition. The basic safety rules, of course, also apply to repairs on vehicles without exception.

Only those repair jobs deviating from those of vehicle type 924 are described in the 944 Workshop Manual. Refer to the 924 Workshop Manual for all other information.

The information is grouped according to repair numbers which are identical to the first two digits of the warranty job codes.

The repair group index, list of contents and the register table are quick guides to find information in the manual.

The layout drawings in this manual are numbered in the order of disassembling and, if necessary, also have information on assembly or installation and application of special tools.

Descriptions of design and function can be found in the service training course reference material.

This Workshop Manual will be kept up to date with Technical Information Bulletins, which will be made part of the manual from time to time. We recommend that these bulletins be filed in the standard type folder provided for this purpose.

List of Repair Groups 944

General	Technical Data	Page 0.1
Repair Groups		Group
	Maintenance, Self-diagnosis	03
Engine	Engine, Crankcase	10
	Engine, Crankshaft, Pistons	13
	Engine, Cylinder Head and Valve Drive	15
	Engine, Lubrication	17
	Engine, Cooling	19
	Fuel Supply	20
	Air Flow Controlled Fuel Injection	24
	Exhaust System/Emission Controls	26
	Starter, Power Supply, Cruise Control	27
	Ignition System DME Diagnosis	28
Transmission	Clutch, Controls	30
	Torque Converter	32
	Manual Transmission, Controls, Case	34
	Manual Transmission, Gears, Shafts	35
	Automatic Transmission, Controls, Case	37
	Automatic Transmission, Gears, Valve Body	38
	Differential, Transaxle System	39
Chassis	Front Wheel Suspension	40
	Rear Wheel Suspension, Axle Shaft	42
	Wheels, Tires, Alignment	44
	Antiblock System	45
	Brakes, Mechanical	46
	Brakes, Hydraulics, Regulator, Booster	47
	Steering	48
Body	Body-Front Section	50
	Body-Center Section	51
	Body-Rear Section	53
	Lids	55
	Doors	57
	Hardtop	61
	Bumpers	63
	Glasses, Window Control	64
	Exterior Equipment	66
	Interior Equipment	68
	Seats	72
	Seat Covers	74
	Airbag Diagnosis	
Heating, Ventilation, Air Condition	Heater	80
	Ventilation	85
	Air Conditioner	87
Electrics	Instruments, Fuel Gauge, Alarm System	90
	Radio, Telephone	91
	Windshield Wipers and Washer	92
	Exterior Lights, Lamps, Switches	94
	Interior Lights	96
	Wiring	97

	Page
General	
Technical data	0.2
Engine, Crankcase	
Tolerances and wear limits	10 - 01
Tightening torques for engine	10 - 03
Engine, removing and installing (manual transmission)	10 - 1
Hydraulic engine mounts, removing and installing	10 - 7
Checking hydraulic engine mounts	10 - 10
Installing new hydraulic engine mounts	10 - 11
Engine, Crankcase, Pistons	
Checking and adjusting tension of Poly-rib belt for alternator and compressor	13 - 1
Checking adjustment of compensating shaft	13 - 2
Checking and adjusting tension of the power pump belt	13 - 2a
Calibrating Special Tool 9201	13 - 2b
Checking and adjusting toothed belt tension - compensating shafts	13 - 3
Checking and adjusting toothed belt tension - compensating shafts (idler pulley with slot)	13 - 6
Installing toothed belt - compensating shaft	13 - 11
Application - assembly stand VW 540 and engine holders 9127 and 9197	13 - 13
Identification of engine number on crankcase	13 - 14
Identification code, crankcase engine number	13 - 14b
Crankcase and crankshaft, disassembling and assembling	13 - 15
Installing cover for the centrifugal compartment	13 - 20 b
Checking crankshaft bearing play	13 - 21
Identification code - upper and lower crankcase sections and compensating shaft cover	13 - 22
Sealing crankcase - upper and lower sections	13 - 23
Installing upper and lower crankcase sections	13 - 24
Aligning upper and lower crankcase sections	13 - 24 a
Installing crankshaft seal (flywheel side)	13 - 25
Flywheel and grooved ball bearing, removing and installing	13 - 26
Refacing the flywheel	13 - 26a
Replacing setscrew (reference mark sensor)	13 - 27
Setting crankshaft to TDC, cylinder 1	13 - 28
Crankshaft dimensions - standard and machined	13 - 29
Checking pistons and cylinder bore	13 - 31
Pistons, disassembling and assembling con rods	13 - 32
Installing pistons with con rods	13 - 34 a
Pistons, from Model 89 onwards	13 - 34 b
Installing pistons with con rods	13 - 35
Holding the flywheel for assembly work (with engine installed)	13 - 37

Page

Compensating shaft drive, disassembling and assembling 13 - 39
 Installing bearing bridges for compensating shafts 13 - 44 f
 Compensating shaft drive, disassembling and assembling 13 - 44 h
 Compensating shaft drive sprockets, installing (Model 84 onwards) 13 - 50
 Machining cylinder bores 13 - 53

Engine, Cylinder head, Valve drive

Camshaft belt tension, checking and adjusting 15 - 1
 Installing camshaft belt and adjusting timing 15 - 5
 Cylinder head, removing and installing 15 - 7
 Tightening specifications for cylinder head 15 - 10 a
 Valve drive, disassembling and assembling 15 - 11
 Machining mating face, cylinder head 15 - 16 a
 Replacing valve guides 15 - 16 b
 Valve drive, disassembling and assembling 15 - 17
 Machining valve seats, checking valve guides 15 - 19
 Valve drive, disassembling and assembling (camshaft housing) 15 - 20
 Camshaft drive, disassembling and assembling 15 - 25
 Camshaft specifications 15 - 28
 Adjusting camshaft belt with mechanical belt tensioner 15 - 29

Engine - Lubrication

Replacing engine oil and oil filter 17 - 1
 Parts of the lubrication system, removing and installing 17 - 3
 Oil pump, disassembling and assembling 17 - 10
 Sleeve for oil-pressure relief valve, removing and installing 17 - 12
 Tightening specifications for oil-pump fastening screws 17 - 13
 Checking oil pressure 17 - 14
 Oil check valve in cylinder head, removing and installing 17 - 16
 Cleaning the engine oil system 17 - 17
 Cleaning the main oil channel in the crankcase 17 - 18
 Pressure-reducing valve, removing and installing 17 - 19

Engine - Cooling

Replacing coolant and bleeding cooling system 19 - 1
 Checking thermostat, checking system for leaks 19 - 3
 Parts of the cooling system, removing and installing 19 - 4
 Parts of the cooling system, removing and installing, Mod. 87 onwards 19 - 6 a
 Radiator, removing and installing 19 - 7
 Temperature switch, removing and installing - checking temperature switch 19 - 9
 Cleaning cooling system after oil and water have been mixed 19 - 11

	Page
Temperature switch, removing and installing - checking temperature switch	19 - 9
Cleaning cooling system after oil and water have been mixed	19 - 11

Fuel supply

Replacing fuel filter, checking injection lines for leaks and tightness	20 - 1
Checking delivery rate of fuel pump	20 - 2
Fuel pump, removing and installing	20 - 3
Fuel tank, removing and installing	20 - 4
Line routing, fuel system	20 - 7
Active-carbon tank for pollution-free fuel-tank bleeding (layout)	20 - 8
Fuel expansion tank, removing and installing	20 - 9
Checking fuel expansion tank	20 - 10
Fuel-level sensor, removing and installing	20 - 11

L-Jetronic fuel injection

Replacing air-filter cartridge	24 - 1
Testing and adjusting specifications	24 - 3
Testing and adjusting specifications for Model 85/2 onward and 924 S	24 - 4
Checking fuel pressure	24 - 5
Adjusting idle speed	24 - 7
Adjusting idle speed - USA vehicles	24 - 9
Correcting CO setting at air-flow sensor - USA vehicles	24 - 12
Injection valves, removing and installing	24 - 13
Checking intake system for leaks - troubleshooting	24 - 15
Adjusting idle speed for Model 85/2 onward and 924 S	24 - 17
Adjusting idle speed - USA and vehicles with catalytic convertor from Model 85/2 onward and 924 S	24 - 20
Testing and adjusting specifications, Model 89 onward	24 - 25
Adjusting idle speed and CO for Model 89 onward	24 - 26
Equipment table for Model 89 onward	24 - 27

Exhaust system

Checking exhaust flanges for tightness	26 - 1
Replacing exhaust pipe or primary muffler/catalytic convertor	26 - 2

Starter, Power supply, Tempostat

Automatic cruise control (Tempostat)	27 - 1
Tempostat control unit, removing and installing	27 - 5
Tempostat operating switch (steering-column switch), removing and installing	27 - 6
Actuator, removing and installing	27 - 7
Tempostat bowden cable, removing and installing	27 - 8

	Page
Tempostat bowden cable, removing and installing	27 - 8
Clutch switch, removing and installing	27 - 9
Troubleshooting - Tempostat	27 - 10
Checking multiple-pin connector of Tempostat control unit	27 - 11
Checking multiple-pin connector of Tempostat actuator	27 - 12
Automatic cruise control (Tempostat) from Model 85/2 onward	27 - 13
Tempostat control unit, removing and installing steering-column switch from Model 85/2 onward	27 - 17
Actuator, removing and installing, from Model 85/2 onward	27 - 19
Clutch switch, removing and installing, from Model 85/2 onward	27 - 20
Troubleshooting - Tempostat - from Model 85/2 onward	27 - 21
Connector assignment, Tempostat control unit	27 - 22
Checking the multiple-pin connectors of the Tempostat control unit from Model 85/2 onward	27 - 23
Alternator, removing and installing	27 - 25

Ignition system

Equipment table	28 - 1
Accident hazards in electronic ignition systems	28 - 3
Ignition-distributor cap, removing and installing	28 - 5
Replacing spark plugs	28 - 7
DEE	28 - 9
Speed and reference-mark sensors, removing and installing	28 - 14
Troubleshooting - DEE	28 - 16
Functional test - Lambda probe	28 - 37
Test - DEE control unit, test - Lambda probe	28 - 38
DEE control unit, removing and installing, from Model 85/2 onward	28 - 39
DEE control unit coding - 924 S from Model 86 onward	28 - 41
DEE control unit coding - 944, from Model 85/2 onward	28 - 42
DEE control unit coding - 944, 2.7 l	28 - 42 a
DEE control unit coding - 944 turbo, from Mod. 85 onward	28 - 43
DEE control unit coding - 924 S, from Model 88 onward	28 - 45
DEE control unit coding - 944, from Model 88 onward	28 - 46
Equipment table engine type M 44.09 to 12	28 - 47

944

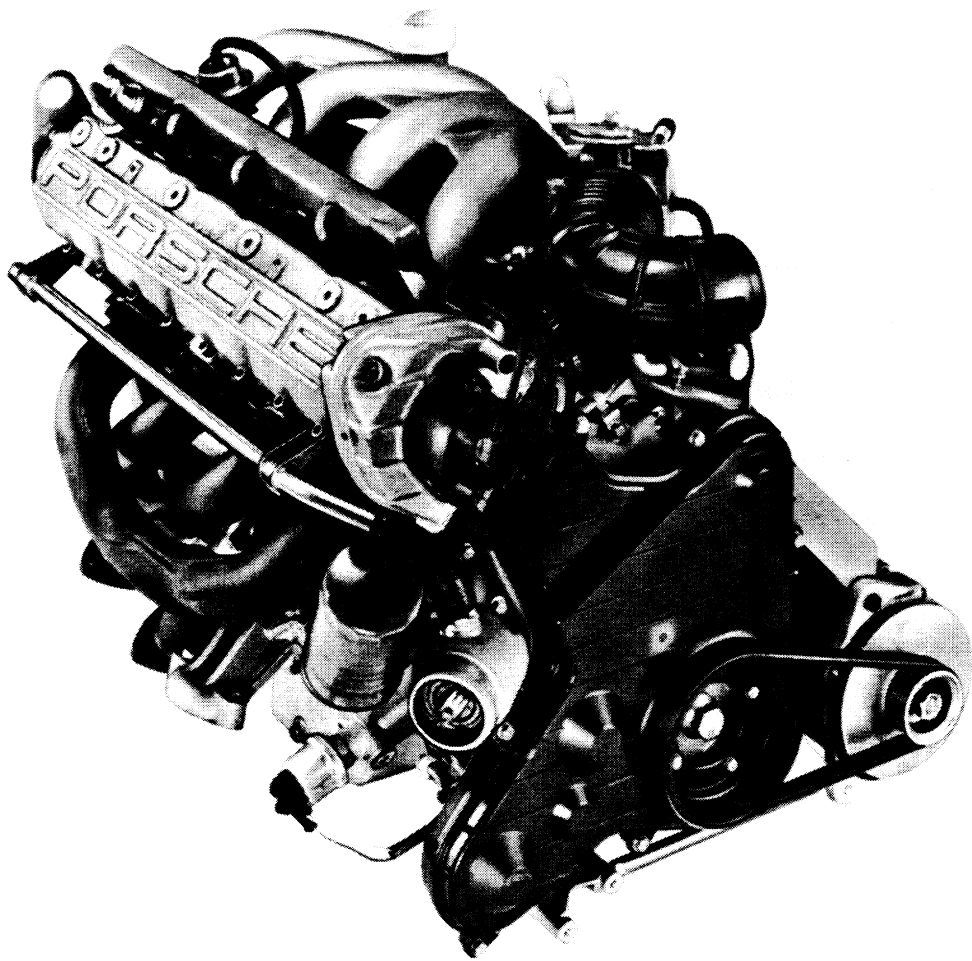

TECHNICAL DATA

(adjusting values and wear limits appear in pertinent repair groups)

Note: USA values in brackets.

Engine		M 44/01 manuals – M 44/03 automatics (M 44/02 manuals – M 44/04 automatics) M 44/05 manuals – M 44/06 automatics (M 44/07 manuals – M 44/08 automatics)
Number of cylinders		4
Bore	mm/in.	100/3.94
Stroke	mm/in.	78.9/3.11
Displacement (actual)	cm ³ /in. ³	2479/151.26
Displacement (fiscal)	cm ³	2449
Compression ratio		10.6 : 1 (9.5 : 1)
Max. engine power to 80/1269/EC	kW/HP	120/163 (110/150)
Net power, SAE J 1349	kW/HP	116/156 (105/143)
At engine speed	rpm	5800 (5500)
Max. torque to 80/1269/EC	Nm/kpm	205/20.9 (192/19.6)
Net torque, SAE J 1349	Nm/ft. lbs.	199/151.3 (186/137)
At engine speed	rpm	3000
Max. specific power output	kW l / HP l	48/66 (44.4/60.5)
Net power to SAE J 1349	kW l / HP l	48/63 (42.4/57.7)
Fuel grade		96 RON (91 RON – unleaded fuel only)
Engine speed limit	rpm	6500
Engine weight (dry)	kg/lbs.	166/366
Engine Design Type		Water-cooled, axial, 4 cylinder, 4 stroke, in-line, internal combustion engine with toothed belt driven overhead camshaft and two compensating shafts
Crankcase		Two-piece, light alloy
Crankshaft		Forged steel
Crankshaft bearings		Five

Connecting rods	Forged steel/cast since February, 1984
Conrod bearings	Plain
Piston pin bearings	Press-fit brass bushings
Pistons	Cast light alloy
Piston pins	Floating installation, secured with circlips
Piston rings	2 compression rings and 1 oil scraper ring
Cylinders	Light alloy
Cylinder head	Light alloy
Valve seat inserts (shrink-fit)	Intake: FCr 330 Exhaust: CoMo 75
Valve guides	Press-fit special brass
Valve arrangement	1 intake, 1 exhaust, overhead, in-line
Exhaust valves	With armored seat
Valve springs	2 coil springs per valve
Valve timing	By overhead camshaft and hydraulic cam followers
Camshaft	Shell hard cast
Camshaft bearings	Camshaft runs in camshaft case without bearing shells
Camshaft drive	Toothed belt with tensioning roller
Valve clearance	Automatic hydraulic adjustment
Timing with 1 mm lift and zero valve clearance	Intake opens 1° after TDC Intake closes 49° after BDC Exhaust opens 43° before BDC Exhaust closes 3° before TDC
Engine Cooling	Closed cooling system, electric fan with thermo switch, antifreeze for – 25° C
Engine Lubrication	
System	Pressure circulation with sickle-type pump, oil filter and oil/water heat exchanger in oil full flow and water bypass integrated in crankcase
Oil pressure at 5,000 rpm	Approx. 4 bar at operating temperature
Oil pressure display	Indicator lamp and pressure gage
Max. oil temperature	140° C
Oil consumption	ltr./1000 km
	Up to 1.5

Exhaust System		Manifold, single pipe up to primary muffler, primary and final mufflers (manifold, single pipe up to 3-way catalytic converter, final muffler)												
Heating		Warm water heater with heat exchanger and blower												
Fuel System		DME (Digital Motor Electronics)												
Fuel supply		1 electric delivery pump												
Fuel grade	RON/MON	96/86 (91/82 unleaded)												
Fuel consumption to 80/1268/EC in	ltr./100 km	<table border="0"> <tr> <td></td> <td>Manuals</td> <td>Automatics</td> </tr> <tr> <td>at 90 km/h</td> <td>6.4</td> <td>6.5</td> </tr> <tr> <td>at 120 km/h</td> <td>8.0</td> <td>8.1</td> </tr> <tr> <td>city cycle</td> <td>11.5</td> <td>11.3</td> </tr> </table>		Manuals	Automatics	at 90 km/h	6.4	6.5	at 120 km/h	8.0	8.1	city cycle	11.5	11.3
	Manuals	Automatics												
at 90 km/h	6.4	6.5												
at 120 km/h	8.0	8.1												
city cycle	11.5	11.3												
Also official specifications for France and Great Britain - ECE A 70 -														
Electrical System														
Interference suppression		ECE - R 10 and 72/245/EC or VDE 0879												
Battery voltage	V	12												
Battery capacity	Ah	50 (63)												
Battery capacity (M-eq.)	Ah	63												
Alternator output	A/W	90/1260, 115/1610 since 1985/2 models												
Ignition		Via DME												
Spark plug connectors		Without booster gap												
Firing order		1 - 3 - 4 - 2												
Ignition timing control		Via DME												
Body Type		Coupe with integral steel body, 2 doors, bolted front fenders, rear window and spoiler tailgate, concealed headlights; removable hardtop roof as optional extra equipment												

D i m e n s i o n s (at DIN curb weight)

Length	mm/in.	4200/165.354 (4290/168.898)
Length with US bumpers as optional equipment	mm/in.	4290/168.898
Width	mm/in.	1735/68.307
Height	mm/in.	1275/50.197
Wheelbase (designed)	mm/in.	2400/94.488
Front track	mm/in.	7J x 15/7J x 16 1477/58.150 6J x 15/6J x 16 1452/57.165 5 1/2J x 15 1440/56.693
Rear track	mm/in.	7J x 15/7J x 16 1451/57.126 6J x 15/6J x 16 1426/56.142 5 1/2J x 15 1414/55.669
Ground clearance (at max. weight)	mm/in.	125/4.921 120/4.72 since 1985/2 models
Bed clearance	mm/in.	53/2.087
Front overhang angle (limited by spoiler)		14°
Rear overhang angle (limited by exhaust)		15°
W e i g h t s (to DIN 70020)		
Curb weight	kg/lbs	1180/2601 (1260/2779) since 1985/2 models: 1210/2668 (1260/2779)
Curb weight axle force		
Front	kg/lbs	580/1279 (620/1367)
Rear	kg/lbs	600/1323 (640/1411) since 1985/2 models: 630/1389 (640/1411)
Max. total weight	kg/lbs	1500/3307 (1550/3418) since 1985/2 models: 1530/3373 (1550/3417)
Max. front axle load	kg/lbs	720/1588
Max. rear axle load	kg/lbs	880/1940, 900/1984 since 1985/2 models
Payload	kg/lbs	320/706 (290/639)
Max. roof load, incl. roof carrier	kg/lbs	35/77 or 75/165 with roof transporting system
Max. trailer load without brakes*	kg/lbs	500/1103
with brakes*	kg/lbs	1200/2646
Max. car/trailer weight	kg/lbs	2700/5952 since 1985/2 models: 2730/6019 (2750/6063)
Max. drawbar load	kg/lbs	50/110

* Gradients up to 16%

Filling Capacities

Engine oil (volume depends on measurement with oil dipstick - see Owner's Manual)	brand name HD oil to API CI, SE or SF - see Owner's Manual
Engine oil volume	approx. 6.0 ltr.
Engine coolant volume	approx. 7.8 ltr.
Transmission with differential volume	approx. 2.0 ltr. of hypoid gear lube SAE 80 to MIL-L 2105, API Classification GL 4
Fuel tank volume	approx. 66 ltr., of which 9 ltr. in reserve since 1985/2 models: approx. 80 ltr., of which 8 ltr. in reserve
Brake fluid volume	approx. 0.2 ltr.
Washing fluid volume for windshield and headlights	approx. 6.0 ltr.

Performance

Top speed	km/h / mph	220/137 (210/130)	
Acceleration from 0 to 100 km/h* (0 to 60 mph)* (1/4 mile)*	sec	Manuels 8.4 (9.3)	Automatics 9.6
	sec	(8.3)	(9.8)
	sec	(16.2)	(17.2)
Kilometer from standing start*	sec	28.8(30.1)	30.5(31.4)

Hill Climbing

In % (slip limit)		Manuels	Automatics
	1st gear	63	55 (38.5)
	2nd gear	36 (34)	25 (19)
	3rd gear	23 (21)	15 (11)
	4th gear	15 (14)	
	5th gear	10 (8)	

* DIN curb weight + 1/2 of payload

Technical Data

Type 944 – Model 88

(Adjusting values and wear limits appear in pertinent repair groups)

Note: USA values in brackets.

Engine

Engine type		M 44/09 (manuals) M 44/10 (automatics)
Bore	mm/in.	100 (3.94)
Stroke	mm/in.	78,9 (3.11)
Displacement (actual)	cm ³ /in ³ .	2479 (151)
Displacement (fiscal)	cm ³	2449
Compression ratio		10.2 : 1
Max. engine power to 80/1269/EC	KW/PS	118 (160)
Net Power, SAE J 1349	KW/HP	118 (158)
at engine speed	1/min	5900
max. torque to 80/1269/EC	Nm/kpm	210 (21.4)
(Net Torque, SAE J 1349)	Nm/lb ft	210 (155)
at engine speed	1/min	4500
max. liter output DIN 70020	KW/l (PS/l)	47.6 (64.5)
(SAE J 1349)	KW/l (HP/l)	47.6 (63.7)
Speed governed by fuel shutoff at	1/min	6640
Engine weight (dry)	kg (lbs)	169 (373)

DESIGNATION OF CYLINDERS

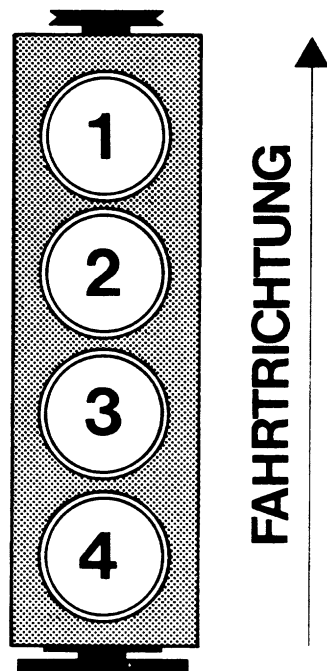

TOLERANCES AND WEAR LIMITS

		New Part	Wear Limit
Cooling System			
Thermostat	Opening temperature	81 – 85 °C (178 – 185 °F)	
Radiator cap High pressure valve	Opening pressure	1 + 0.15 – 0.10 bar (14,5 + 2.1 – 1.5 psi)	
Low pressure valve	Opening pressure	0.1 bar (1.5 psi)	
Oil Circuit			
Oil consumption	ltr./1000 km (600 mi./US qt)		approx. 1.5
Oil pressure at 80 °C (176 °F) oil temperature and at 5000 rpm	Pressure	approx. 4 bar (58 psi)	
Oil dipstick Upper mark Lower mark	Capacity Capacity	5.5 ltr. (5.8 US qt) 4.2 ltr. (4.4 US qt)	
Valve Timing			
Camshaft bore	Inside dia.	60.5 + 0.03 – 0	
Camshaft	Diameter	60.5 – 0.04 + 0.055	
Camshaft	End play	0.10 – 0.18	
Cam follower bore in camshaft housing	Inside dia.	38 + 0.027 + 0.007	
Cam follower	Diameter	38 – 0.018 – 0.034	
Camshaft	Runout	0.02	

TOLERANCES AND WEAR LIMITS

		New Part	Wear Limit
Cylinder Head and Valves			
Mating surface	Distortion		max. 0.08
Valve seat:			
Intake	Width	1.7	
Exhaust	Width	2.0	
Intake	Seat angle	45°	
Exhaust	Seat angle	45°	
Outer correction angle		30°	
Inner correction angle		60°	
Valve guides:			
Intake and exhaust	Inside dia.	9 + 0.015	
Valve stem:			
Intake	Diameter	8.97 – 0.012	
Exhaust	Diameter	8.95 – 0.012	
Valve guide/valve stem			
Intake		0.8	
Exhaust		0.8	
Compression	Pressure	10 bar (145 psi) or more	

TOLERANCES AND WEAR LIMITS

		New Part	Wear Limit		
Pistons and Connecting Rods					
Cylinder/piston	Clearance	0.008 – 0.032	approx. 0.080		
		Mahle	KS		
Piston rings	Side clearance	Groove 1	0.05 – 0.082	0.05 – 0.082	
			Groove 2	0.04 – 0.072	0.05 – 0.082
		Groove 3		0.023 – 0.137	0.023 – 0.137
			Piston rings	End gap	Groove 1 = 0.20 – 0.45
		Groove 2 = 0.20 – 0.45			
		Groove 3 = 0.38 – 1.40			
Connecting rod bushing	Diameter	24 + 0.018 + 0.028			
Piston pin	Diameter	24 – 0.004			
Connecting rod bushing/ piston pin	Radial play	0.018 – 0.032			
Crankshaft and Engine Block					
Crankshaft	Runout	0.04 – 0.06	max. 0.08		
Connecting rod bearing journal	Diameter	51.971 – 51.990			
Connecting rod bearing/ crankshaft	Radial play	0.034 – 0.092			
	End play	0.100 – 0.400			
Crankshaft bearing journal	Diameter	69.971 – 69.990			
Crankshaft bearing/crankshaft	Radial play	0.020 – 0.098			
	End play	0.110 – 0.312	0.40		
Cylinder bore	Out-of-round	0.010	0.020		
Bore for balance shaft bearing shells in crankcase and balance shaft cover	Diameter	35.000 – 35.019			
Bore for bushing in bearing housing	Diameter	34.000 – 34.019			
Balance shaft	Diameter	30.975 – 30.991			

Tightening torques for engine

Location	Thread	Tightening torque Nm (ftlb)	
Crankshaft/ Crankcase			
Bolts - upper and lower crankcase sections (studs)	M 12 x 1.5	30(22)	1st stage
		60° torque angle	2nd stage
	M 10	20(15)	1st stage
		50(37)	2nd stage
	M 8	20(15)	
	M 6	10(7.5)	
Rotary body on compensating shaft	M 6	10(7.5) secured with Loctite 270	
MODEL 82 - 85 Cover for compensating shaft housing to upper crankcase section	M 6	8(6)	
Hexagon head screw	M 8	15(11)	1st stage
		20(15)	2nd stage
Stud	M 8	15(11)	1st stage
		30(22)	2nd stage
MODEL 85 ONWARD Compensating shafts with separate bearing bridges:			
Bearing bridges (nuts) of compensating shafts to upper crankcase section	M 8	15(11)	1st stage
		33(24)	2nd stage
Cover for compensating-shaft housing to upper crankcase section	M 6	10(7.5)	
Hexagon head screw	M 8 x 55	15(11)	1st stage
		20(15)	2nd stage
MODEL 87 ONWARD Hexagon head screw (bearing bridge) for compensating-shaft housing to upper crankcase section	M 8 x 58	15(11)	1st stage
		33(24)	2nd stage
Bearing housing left and right to upper crankcase section	M 8	20(15)	

Location	Thread	Tightening torque Nm (ftlb)	
Con rod bolt Verbusrip nut	M 10 x 1.25	75(55) + 5(4)	
Con rod bolt with smooth contact surface	M 10 x 1.25	57(42) + 5(4)	
Water drain plug in upper crankcase section	M 8	20(15)	
Oil pan to crankcase	M 6	hand tight 4(3) 10(7.5)	1st stage 2nd stage 3rd stage
Oil pan insert to oil pan	M 5	6(4.5) secured with Loctite 270	
Oil drain plug	M 20 x 1.5	50(37)	
Engine supports left + right to crankcase	M 10	48(35)	
Flywheel to crankshaft	M 10 x 1.25	90(66)	
Sensor holder to crankcase	M 8	20(15)	
Toothed gear to crankshaft	M 16 x 1.5	210(155)	
Sensor to holder	M 6	8(6)	
Pulley to toothed gear	M 6 x 25 Tensile strength 10.9	13(9.5)	
Toothed gear to compensating shaft	M 10	45(33)	
Tension pulley to bearing housing	M 10	45(33)	
Water pump to crankcase	M 6	8(6) secured with Loctite 270	
Idler pulley to water-pump housing	M 10	45(33)	
Tensioning pulley to oil-pump housing	M 10	45(33)	
Oil pump to crankcase	M 6 M 10	8(6) 45(33)	
Belt tensioner to crankcase	M 8	20(15)	

Location	Thread	Tightening torque Nm (ftlb)
Tensioning pulley to belt tensioner	M 10	45(33)
Fastening - belt cover	M 6	8(6)
Console for generator to crankcase	M 10	45(33)
Remote thermometer sensor	M 10 x 1	35(26)
Temperature sensor (NTC II)	M 12 x 1.5	15(11)
Oil pressure sensor	M 18 x 1.5	35(26)
Housing insert in oil-pump housing	M 6	8(6) mating surface sealed with Loctite 574
Cooler housing/thermostat housing to crankcase	M 8	20(15)
Sealing plug to oil/water-cooler housing	M 18 x 1.5	35(26)
Coolant bleeder screw	M 8 x 1	12(9) + 3(2)
Pressure-relief valve	M 20 x 1.5	45(33)
Oil filter		20(15)
Oil separator to crankcase	M 8	20(15)
Cylinder head		
Cylinder head fastening to upper crankcase section		Refer to Page 15 - 10 a
Intake tube to cylinder head	M 8	20(15)
Inlet connectors - heating to cylinder head	M 8	20(15)
Connector for water pipe	M 8	20(15)
Camshaft housing to cylinder head	M 8	20(15)
Aluminium sealing plugs to camshaft housing	M 18 x 1.5	40(29.5)
Camshaft bearing to camshaft housing	M 6	8(6)

Location	Thread	Tightening torque Nm (ftlb)
Camshaft pulley to camshaft Allen screw	M 10	45(33)
Screw with internal serrations	M 10	65(48) - 70(52)
Console to camshaft bearing	M 6	8(6)
Connector to driver	M 5	5(4) secured with Loctite 221
Distributor rotor to connector	M 4	4(3) self-locking
Transport strap to cylinder head	M 6	8(6)
Spark plugs	M 14 x 1.25	25(18) - 30(22)
Fuel system		
Fastening - diaphragm damper and pressure regulator to fuel collection pipe	M 16 x 1.5	30(22)
Cap nut to fuel collection pipe	M 12 x 1.5	12(9)
Exhaust system		
Sealing nut to catalytic convertor	M 14 x 1.5	30(22)
All other screws and nuts:		
	M 6	8(6) + 2(1.5)
	M 8	20(15) + 2(1.5)
	M 10	40(29) + 5(4)

TOOLS

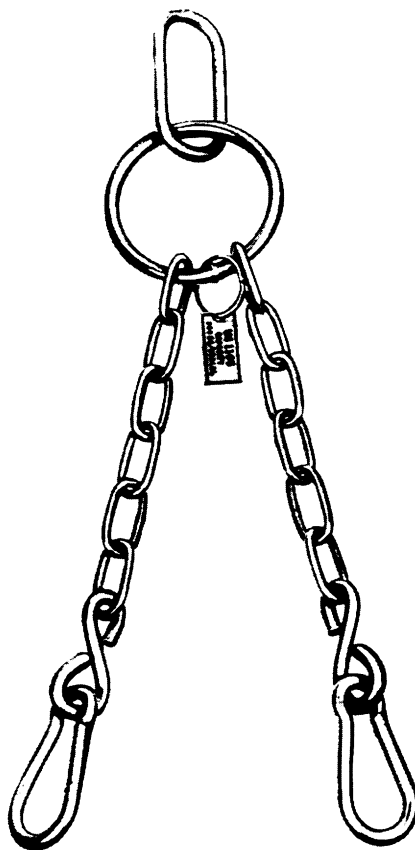

No.	Description	Special Tool	Remarks
1	Chain sling	US 1105	

REMOVING AND INSTALLING ENGINE (Manual Transmission)

Engine removed from underneath.

Clutch bell housing remains on engine.

Removing

1. Set up hoist and lift car on the pick-up points.
2. Use fender covers.
3. Remove front wheels.
4. Disconnect battery ground cable.
5. Disconnect battery positive cable and push through splash wall with the rubber grommet.

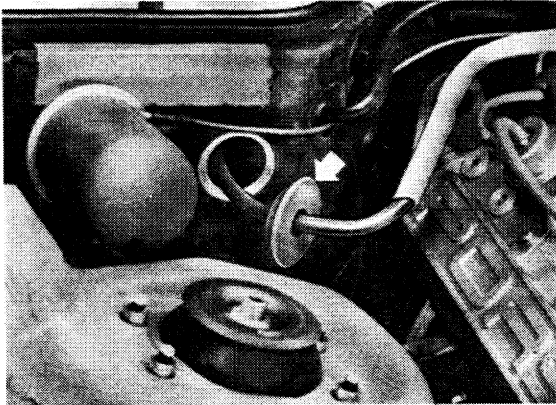

6. Disconnect two plugs for engine wire harness. Remove wire clamps.

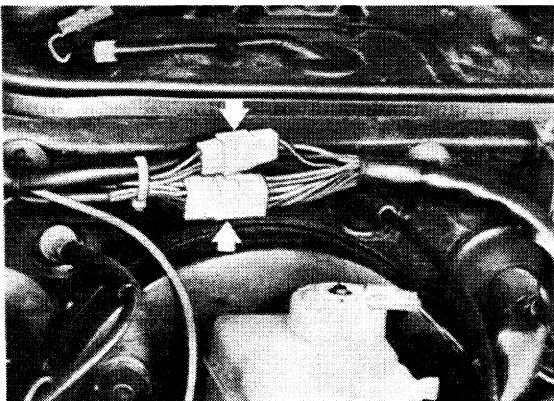

7. Pull off wire plugs on control unit (in area of steering column).

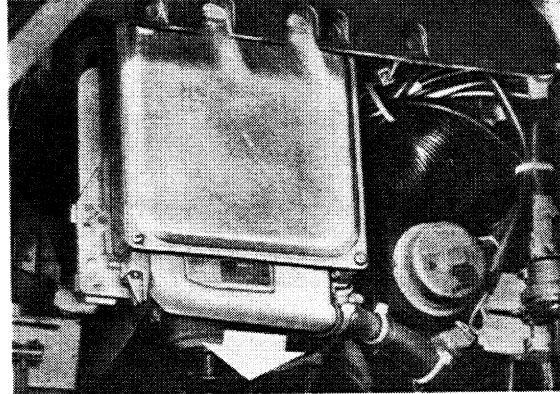

8. Push wires and plugs through splash wall. Detach bracket with sensor wire on intake pipe to make engine removal easier.

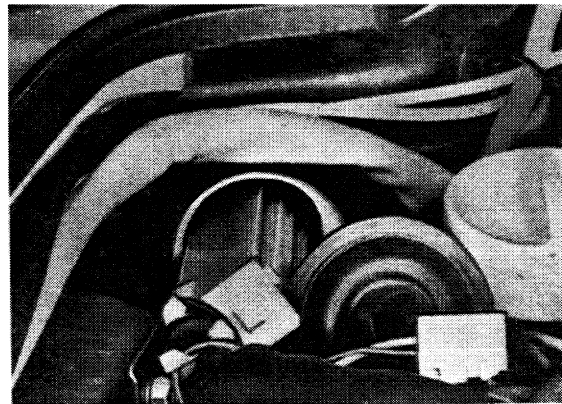

9. Disconnect throttle operating cable. Disconnect and pull off vacuum hose on brake booster.

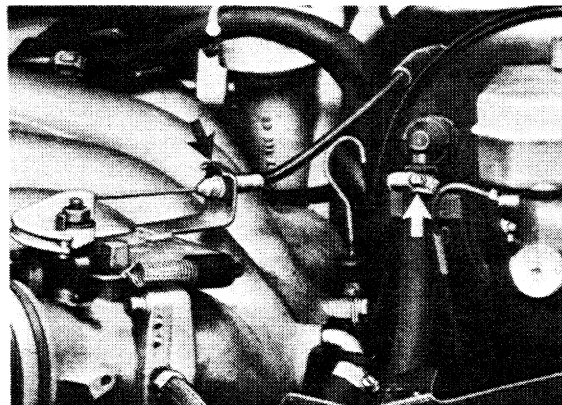

10. Disconnect air cleaner with air flow sensor on body and on coolant hose, and lay aside.

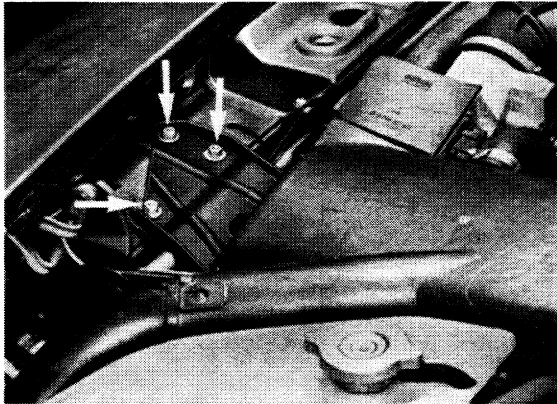

11. Remove distributor cap, distributor rotor and dust cap (to avoid damage).

12. Disconnect ground wire on splash wall.

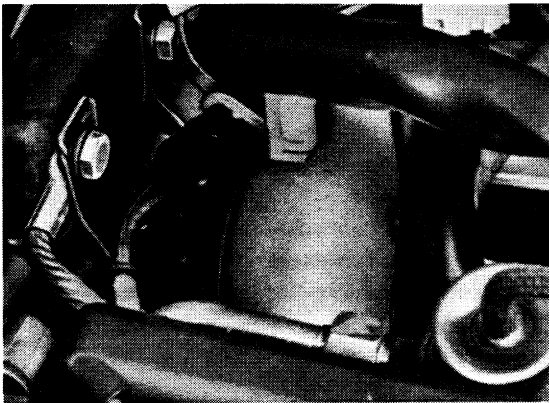

13. Pinch fuel return line with a standard hose clamp. Unscrew fuel feed line while counterholding.

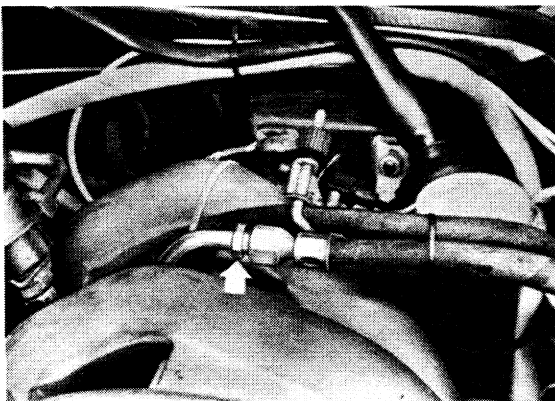

14. Unscrew fuel return line.

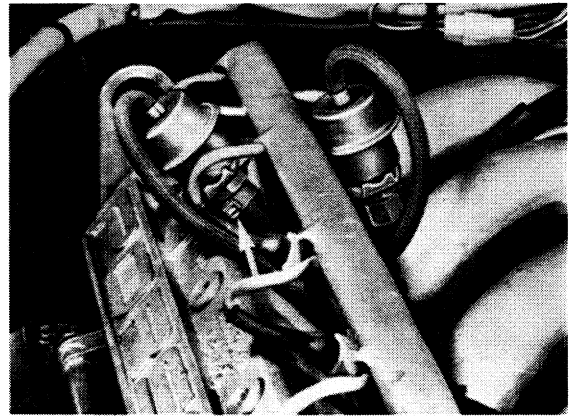

15. Attach Special Tool VW 10-222 on front transport bracket of engine and hold engine tight in installed position.

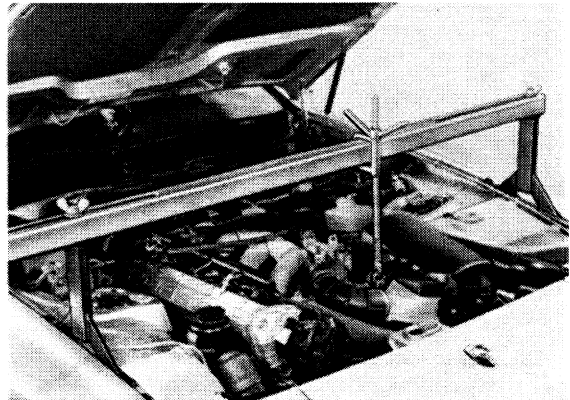

16. Open heater regulating valve. Remove cap on coolant expansion tank.

17. Remove splash shield.

18. Remove exhaust assembly, by unscrewing flange, exhaust manifold/exhaust pipe connections and suspension points.
USA cars:
Also disconnect oxygen sensor plug and wire in metal lug on firewall.

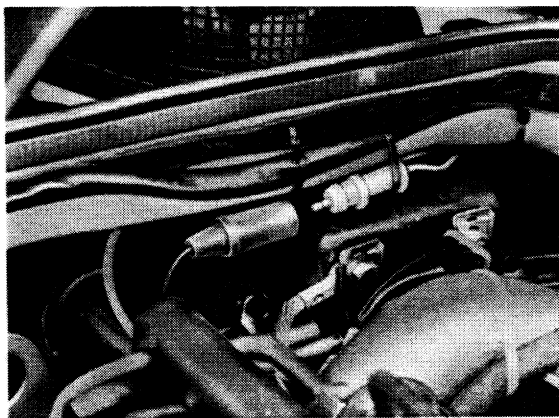
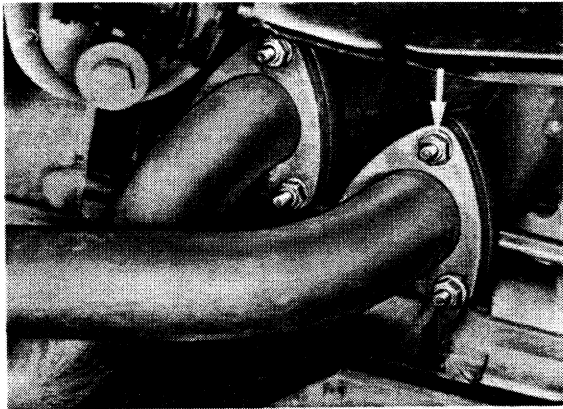

19. Disconnect electric wires for starter.
Unscrew and remove starter.
20. Unscrew clutch line clamp on engine.
21. Unscrew clutch slave cylinder on clutch housing (line remains connected).

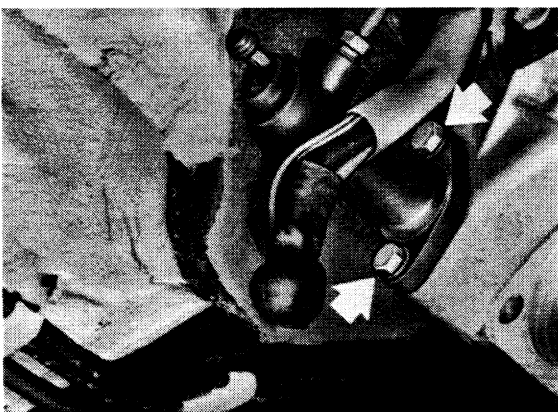

22. Unscrew stabilizer on body and control arms, and remove.
23. Unscrew shield for right engine mount on front axle cross member.
24. Unscrew universal joint on steering gear, tie rods on steering arms, upper hydraulic engine mount on engine braces, left and right control arms on front axle cross member, and remove front axle cross member with steering from underneath.

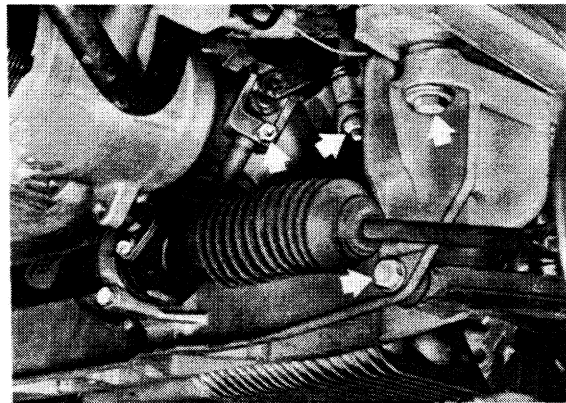

25. Cars with Air Conditioner:
Unscrew poly-rib belt tensioner and take off belt.
26. Unscrew compressor on console (don't disconnect refrigerant hoses). Suspend compressor from the spring strut with a piece of wire.

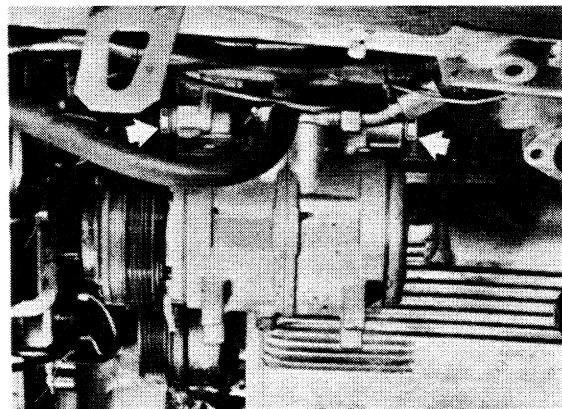

27. Drain coolant through drain plug bore in radiator or the coolant hose and catch coolant.

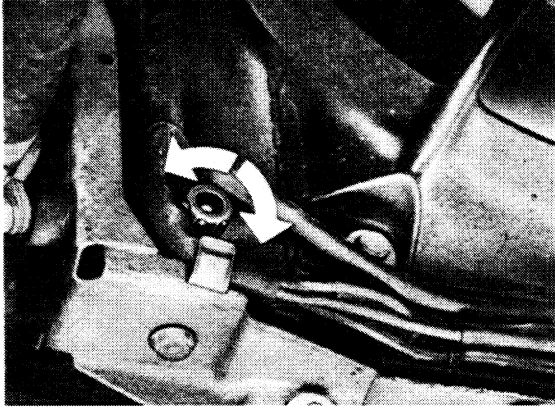

28. Remove coolant hose on bottom of radiator.
29. Remove upper central tube mounting bolts.
30. Lower car.
31. Remove coolant hose on heater valve.
32. Remove coolant return hose for heater.

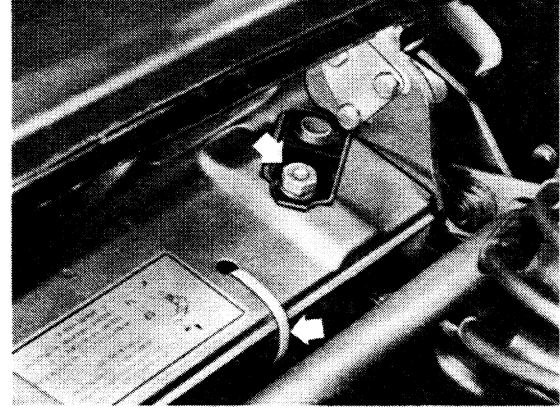

41. Attach Special Tool US 1105 on engine (shorter end towards rear of engine).
42. Lift engine slightly and remove VW 10-222.
43. Remove lower central tube mounting bolts.
44. Lower engine, pull forward and remove from underneath.

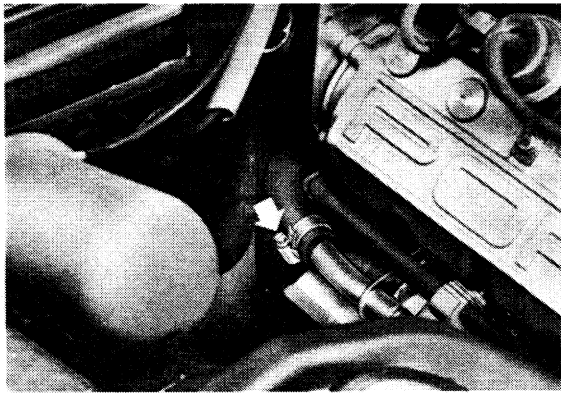

33. Remove coolant feed hoses on expansion tank.
34. Remove A/C fast idle hose.
35. Remove charcoal venting hose.
36. Remove vacuum line to vent valve and vacuum line to thermo valve at back of engine.
37. Remove upper radiator hose.
38. Remove radiator vent hose.
39. Remove wiring to temperature switch and both cooling fans.
40. Remove top radiator brackets and lift out radiator with cooling fans.

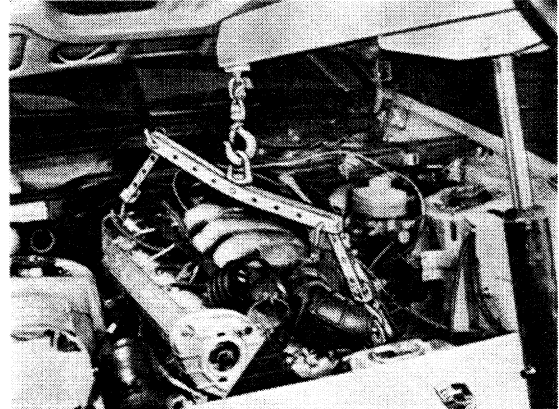

Installing

Note the following for installation.

1. First insert transaxle/clutch housing mounting bolts, but do not tighten.

Note

Only tighten mounting bolts to final torque after hydraulic engine mount and front axle cross member have been mounted.

Torque for mounting bolts: 42 Nm (30 ft lb).

Front wheel alignment need not be checked after removal and installation of engine.

2. Make sure radiator fits correctly in rubber mounts.
3. Secure coolant hose (between radiator and expansion tank) on lock carrier with two straps.

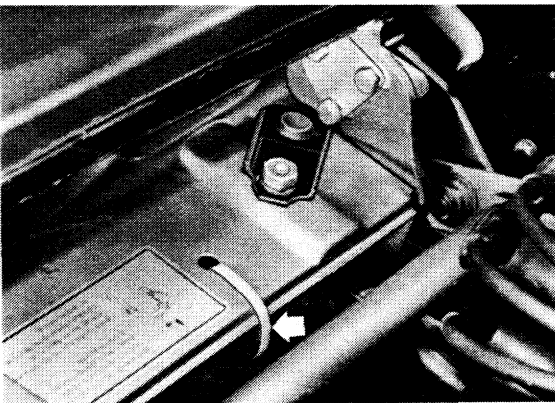

4. Tighten bolts and nuts to specified torque.
5. Fill and bleed cooling system (see page 19-1).

REMOVING AND INSTALLING HYDRAULIC ENGINE MOUNTS

R e m o v i n g

1. Disconnect battery ground lead.
2. Suspend engine from front transport bracket with Special Tool VW 10 - 222 or VW 10 - 222 A and hold firmly in installed position.

Pull off plug on air flow sensor and vent hose on air cleaner to have access to the transport bracket.

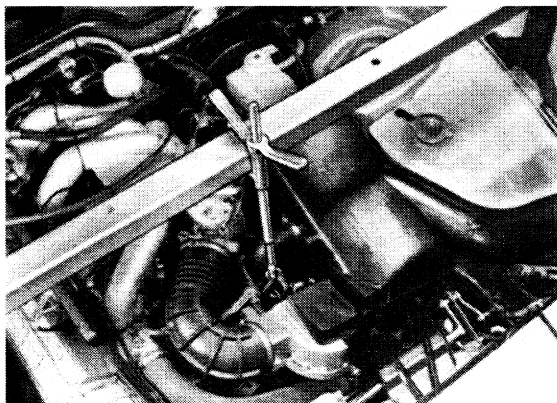

5. Unscrew shield for right engine mount on front axle cross member.

6. Unscrew hydraulic engine mount on front axle cross member.



7. Cars with power steering:
Disconnect return line of hydraulic steering system on side member.
In cars prior to 1984 models first unclip brake pad wear indicator wire and remove clip on bolt.

3. Remove splash guard.
4. Remove stabilizer after unscrewing stabilizer mounts on control arms and stabilizer suspension on side members.

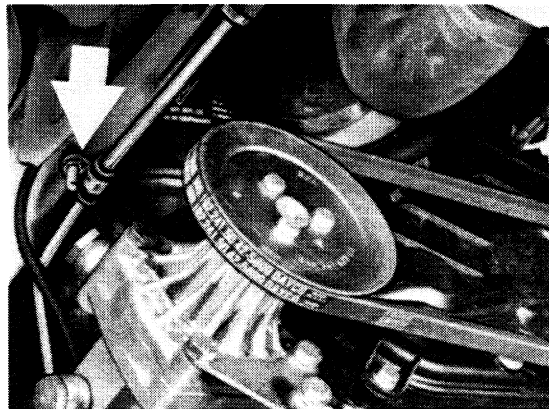

8. Unscrew universal joint on steering gear, hydraulic engine mount on engine brackets and front axle cross member on side members.

Note :

Mark installed position of universal joint to steering gear.

Do not unscrew control arm mounting bolts, since otherwise front wheel alignment would have to be checked and adjusted.

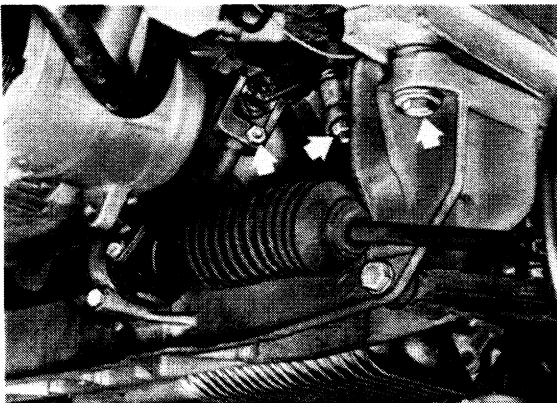

9. Pull down front axle cross member and remove universal joint (drive shaft) on steering gear.

Note :

Only pull down front axle cross member far enough to permit removal of the hydraulic engine mount.

10. Move top of hydraulic engine mount out of front axle cross member (see arrow).

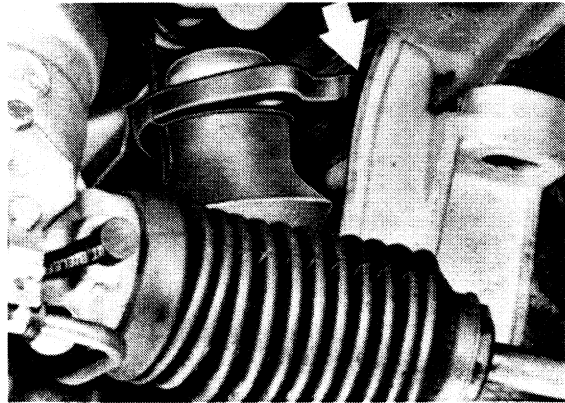

11. Remove hydraulic engine mount toward front. If necessary because of limited space first turn mount 180°.

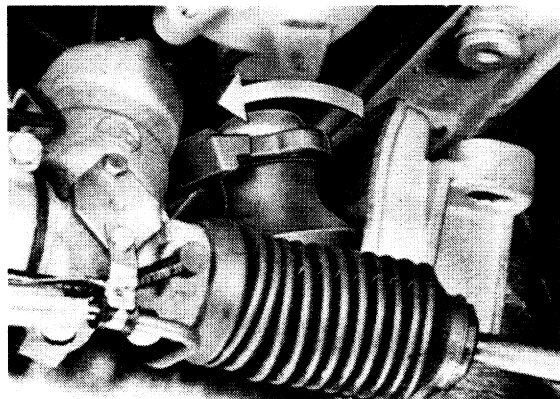

Installing

1. Insert hydraulic engine mount that twist lock (arrow) is positioned on the stop (stop is at rear on the right-hand side). With hydraulic engine mount in this position press top of it into front axle cross member (see point 10 of removing).

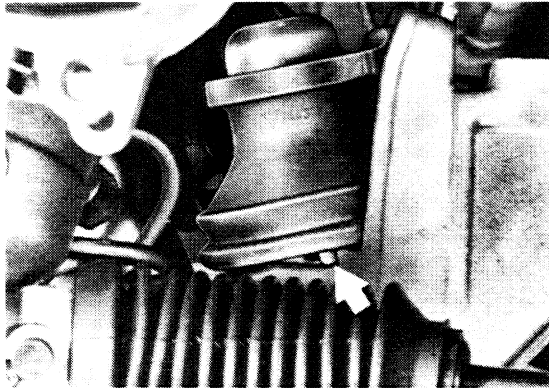

2. Push correctly positioned universal joint (drive shaft) on to steering gear (steering pinion).
Mount front axle cross member.
Center front axle cross member before tightening mounting bolts to 85 Nm.

Note:

Lift front axle cross member with an universal transmission jack, e. g. Hahn Metallbau GmbH, Ringstr. 12 – 18, 7012 Fellbach, or some other suitable lifting fixture to be able to insert the bolts.

3. Install mounting nuts and bolts for hydraulic engine mounts, but do not tighten.
4. Remove Special Tool VW 10 - 222 or VW 10 - 222 A.
Connect plug on air flow sensor and vent hose on air cleaner.

5. Tighten self-locking mounting nuts in the order given below.
Hydraulic engine mount to front axle cross member.
Hydraulic engine mount to engine brackets.
Universal joint to steering gear.
Use new self-locking nuts and torque to 30 Nm.
6. Cars with power steering:
Secure return line and, if applicable, brake pad wear indicator wire on side member.
7. Mount right engine mount shield, stabilizer and splash guard.
Tightening torque for stabilizer to body and control arms: 23 Nm.
Connect ground lead on battery.

CHECKING HYDRAULIC ENGINE BELTS

General Information

Hydraulic engine mounts cannot be tested 100% with conventional workshop equipment. However, the test procedures listed below can be used to determine whether hydraulic engine mounts are defective or seriously impaired in effectiveness.

Of the two hydraulic engine mounts, the one on the right is subjected to greater thermal loading and thus more likely to give cause for complaint.

Checking

Symptoms indicating a damaged engine mount:

- Clearly-discernible knocking or vibration while starting and/or turning off the engine.
- severe engine vibration in idle (with engine in perfect condition and balance shafts adjusted correctly).
- no or insufficient spring travel when pulling down on engine. Specification: 2 - 3 mm. (Do not check left and right hydraulic engine mounts together. Use exhaust pipes for leverage).
- Visual inspection shows leaks (mounts are filled with a damping fluid), rubber peeling off, cracks, or notching.
- Height of removed and de-tensioned hydraulic engine mount is less than 65 mm (new 70 ± 1 mm) measured between bearing surfaces.

(Height of installed hydraulic engine mount not less than 62-2 mm)

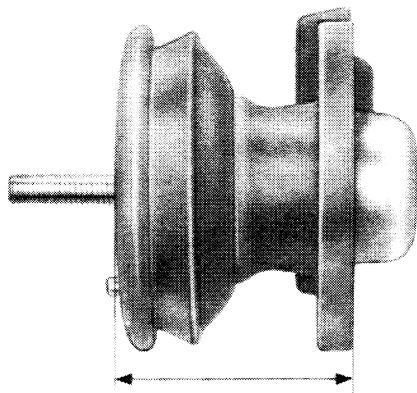

Installing new hydraulic engine mounts

Vehicle type 924 S - 944 - 944 S - 944 S2 - 944 turbo

Note

The old hydraulic engine mount that was fitted using 4 mm spacers has been discontinued and is therefore no longer available.

Modifications of the new hydraulic engine mounts:

- Changed design
- Installation height of the engine mounts was increased by 4 mm, rendering the 4 mm spacers obsolete.
- The hydraulic engine mount is fitted to the engine support using 2 bolts.
Old hydraulic engine mount:
2 bolts with washers and nuts.

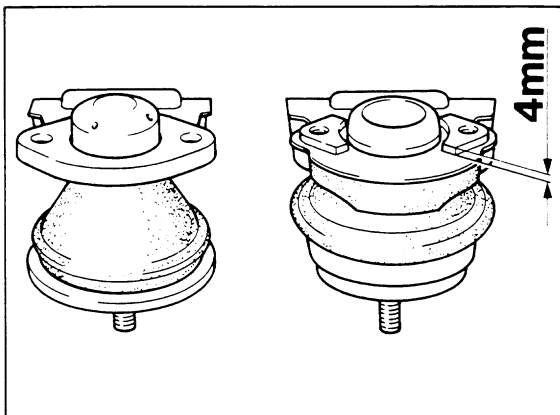

725/10

1. The new hydraulic engine mount may be retrofitted to all vehicles as of Model Year '82. Combined use of new and old hydraulic engine mounts is permissible.
2. Use only M 8x38 or M 8x42 bolts without washers. Pay attention to flange dimension X of left-hand engine support.
X = 21 + 1 mm: Bolt M 8 x 38
X = 25 + 1 mm: Bolt M8 x 42
For the right-hand engine mount, use only the M 8 x 38 bolt without washer.
Tightening torque 23 Nm (17 ftlb)

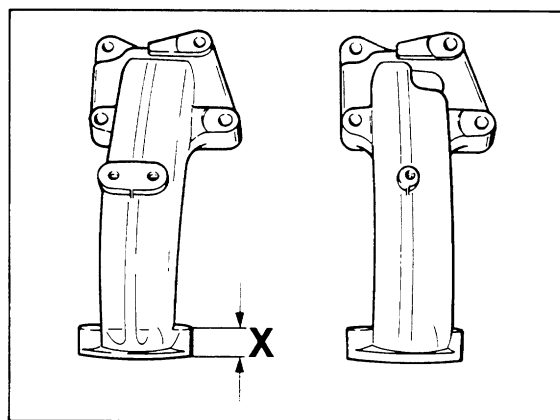

726/10

Stocks of the old engine mount may be used up. In this case, also note engine support flange dimension X.

- X = 21 + 1 mm: Hydraulic engine mount with spacers
- X = 25 + 1 mm: Hydraulic engine mount without spacers

Polyrib drive belt for alternator or a/c compressor

5-rib poly-rib belt

Checking

1. Prepare Special Tool 9202 for checking. Pull out lockpin on special tool and slide out testing pin opposite the lockpin completely. Place drag needle on indicator needle.
2. Slide special tool on to the drive belt. Push in testing point (arrow) slowly until the lockpin is felt to engage, and read the displayed value from the dial gage.
Adjusting value: $9,5 \pm 0,3$ scale units. Correct belt tightness if necessary.

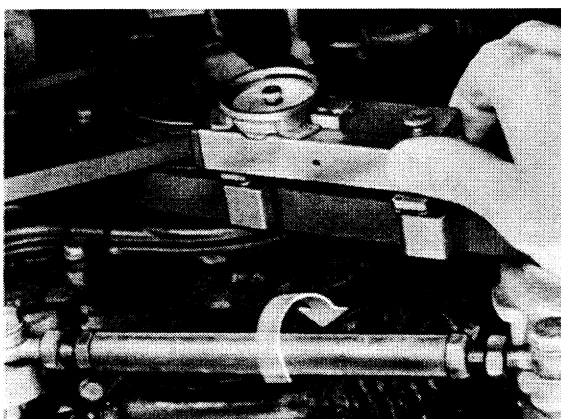

Note

The slides must have complete contact on the belt surface.
The special tool must not be turned or moved on the belt while checking.

Adjusting

1. Loosen hexagon head bolts of connecting rod slightly
2. Loosen lock nuts of connecting rod and turn connecting rod accordingly until the correct belt tightness is reached.

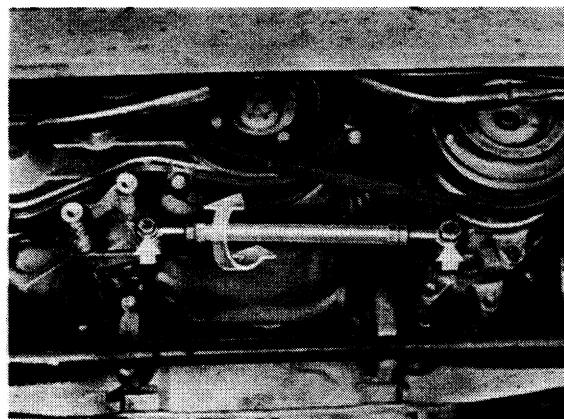

6-rib poly-rib belt

Adjusting

1. Loosen hexagon head bolts of connectrod slightly. Loosen lock nuts of connecting rod and turn back connecting rod one turn (reduces tension).
2. Prepare Special Tool 9201 for checking.

Adjustment value without air conditioning

Turn connecting rod until a value of 9.5 on the scale is reached.

Adjustment value with air conditioning

Adjustment value 9.5 on the scale, then turn connecting rod 1 more revolution (to increase tension)

CHECKING ADJUSTMENT OF BALANCE SHAFTS

1. Remove splash shield.
2. Turn crankshaft clockwise until TDC mark on camshaft sprocket is aligned with cast mark in mount for ignition cap.
TDC marks on flywheel and cast clutch housing must also be aligned.
3. Take off upper drive belt cover.

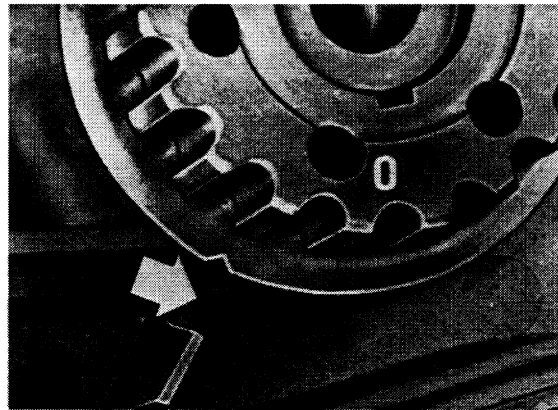
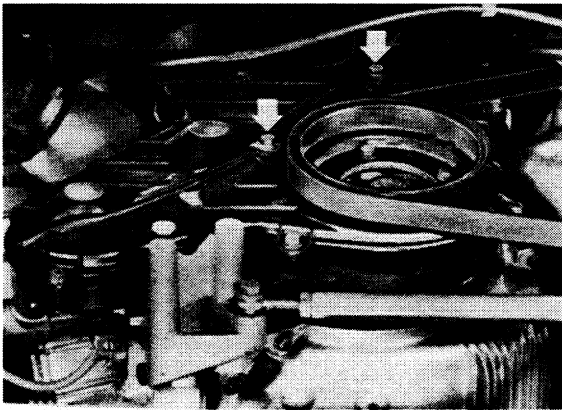
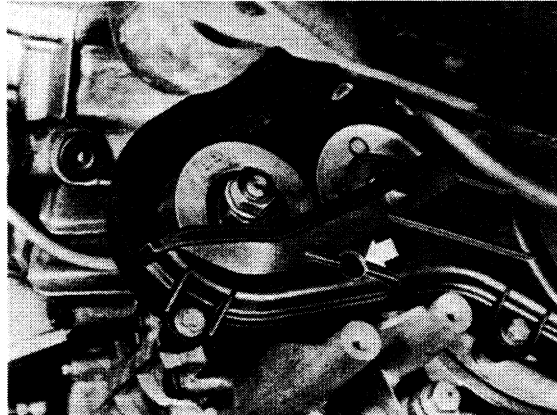

4. Mark on upper balance shaft sprocket must be aligned with mark of rear drive belt cover.

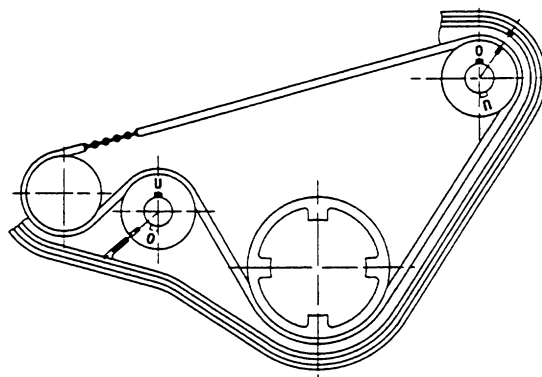
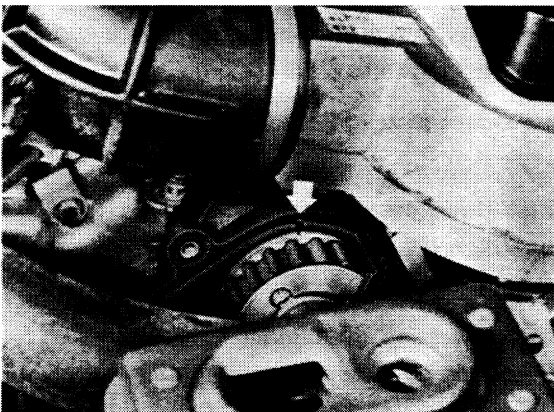

5. Remove end cap in lower drive belt cover.
Check position of mark on lower balance shaft sprocket through this hole.
Mark on sprocket must be aligned with mark of rear drive belt cover.

CHECKING AND ADJUSTING TIGHTNESS OF POWER STEERING PUMP DRIVE BELT

Checking

Check tightness by applying thumb pressure on belt at point midway between two pulleys.
Deflection: approx. 5 mm.

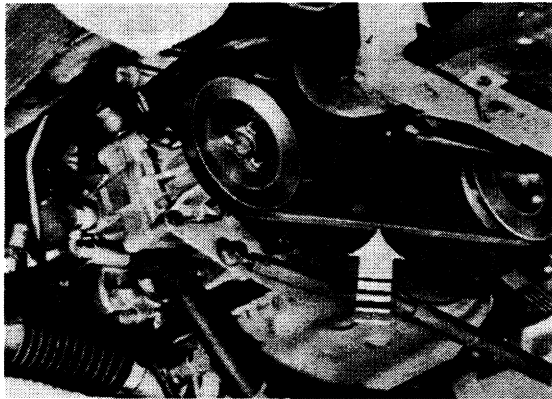

3. Loosen bolts of pressure rod slightly.

Unscrew lock nuts of pressure rod and turn rod accordingly until correct belt tightness is reached.

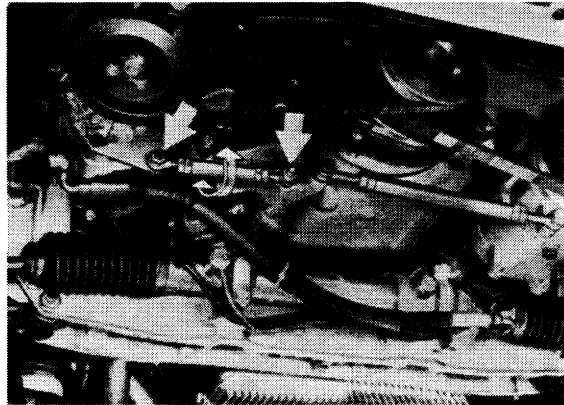

Adjusting

1. Remove splash shield.
2. Loosen upper mounting bolt or nut slightly.

4. Tighten mounting bolts and nuts after finishing adjustment.

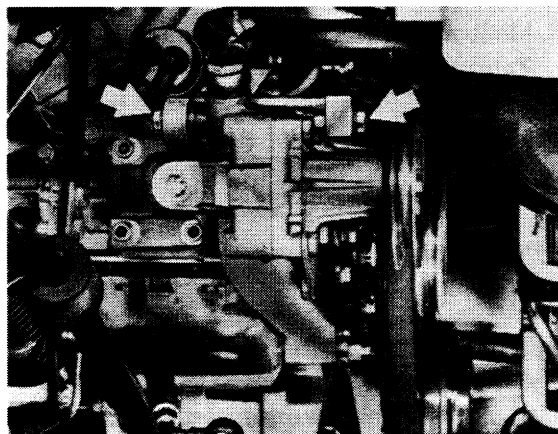

CALIBRATING SPECIAL TOOL 9201

TOOL

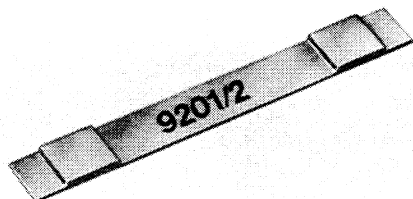

The testing gage is designed for a display of 4.0 scale units and permits the checking and calibrating of Special Tool 9201 to 4.0 scale units.

The tool must be calibrated after:

- about 100 measurements,
- hard jolts or knocks
- slight damage.

Calibration will not be sufficient in case of greater damage or display deviation of more than 2.0 scale units. These special tools can be sent to the supplier for repairing.

Address:

Fritz Staeger
Zossener Str. 56/58
D-1000 Berlin 61
Tel.: 030 / 693 1204

CALIBRATING

Tools Required:

Small screwdriver 1.6 x 40 x 0.4 mm
Gage 9201/2

1. Adjust to zero point by turning the dial gage's scale ring until the needle and zero point are aligned.
2. Insert gage 9201/2, checking for centered position of both test bearing surfaces on the sliding shoes.

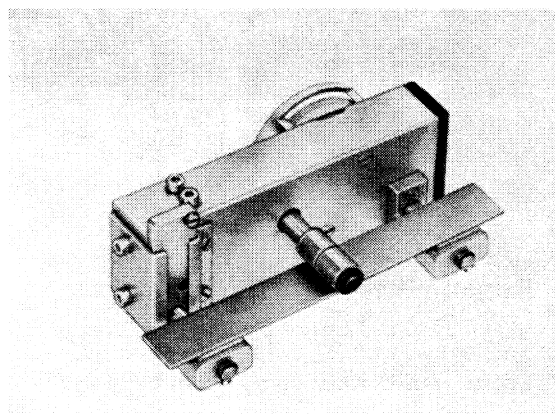

3. Proceed to same procedures for use on toothed belt, i.e. press in testing point slowly until the lock pin is felt to engage and then read the displayed value from the dial gage.

Note

Sliding shoes of older manufacture might be bored offcenter. Depending on the position of the sliding shoes there could be different displayed values when checking with this tool.

Consequently the measurement with a gage should be repeated with different sliding shoe positions. Find the position, where the scale value is closest to the 4.0 adjusting value. Mark sliding shoe (e.g. with paint or an electric inscriber) and perform the calibration as well as all measurements later at this position.

4. If the display is outside of the test value of 4.0 ± 0.3 scale values, readjust the gage dial. This is done by turning the calibration screw with a small screwdriver until the specified value of 4.0 scale units is reached. In so doing the gage 9201/2 remains between the test sensor of the tester.

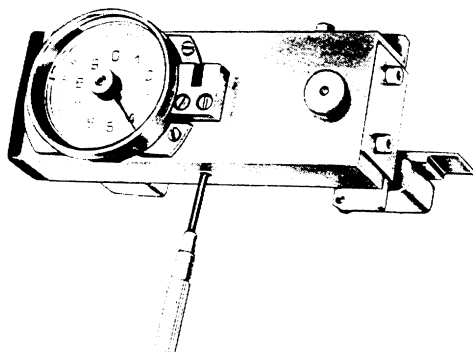

5. Recheck after finishing calibration.

CHECKING AND ADJUSTING TIGHTNESS OF DRIVE BELT FOR BALANCE SHAFTS (ROLLER WITH SLOT)

Note:

Only check and adjust drive belt tightness on a cold engine (ambient temperature approx. 20°C/68°F).

1. Remove splash shield.

2. Remove poly-rib belt.

Note

Always first loosen bolts of pressure rod slightly prior to unscrewing locknuts.

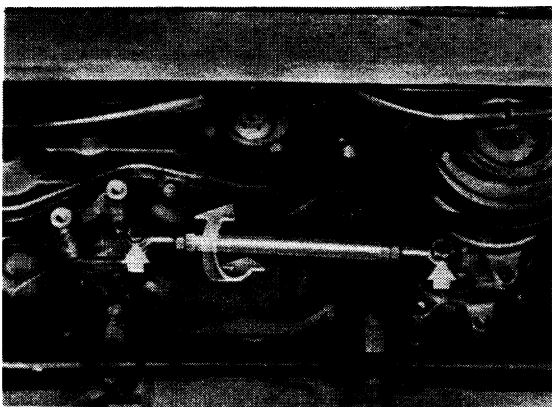

3. Unscrew vent hose and take off drive belt cover.

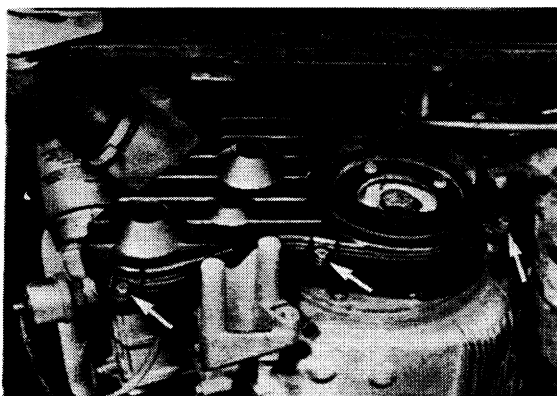

4. Loosen idler pulley so that pulley does not touch drive belt.

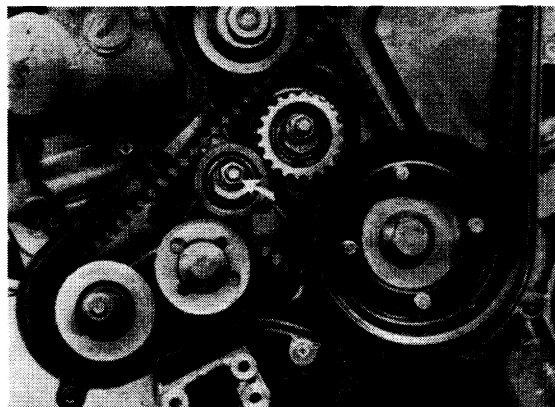

5 a. Turn crankshaft clockwise until TDC mark on camshaft sprocket is aligned with cast mark in mount for distributor cap.

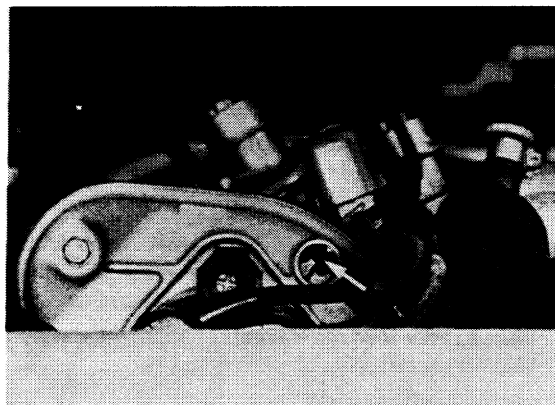

5 b. TDC marks on flywheel and cast clutch housing must also be aligned.

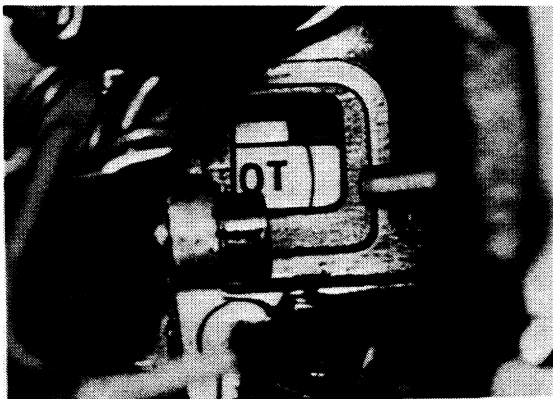

6. Check basic position of balance shaft sprockets. Marks on sprockets should be aligned with marks of rear drive belt cover.

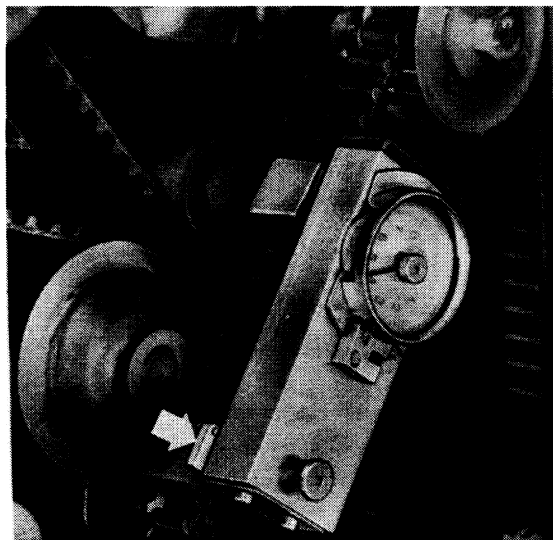

9. Adjusting:
Turn tensioner clockwise to tighten.
Turn tensioner counterclockwise to loosen.
Tighten nut to specified tightening torque.

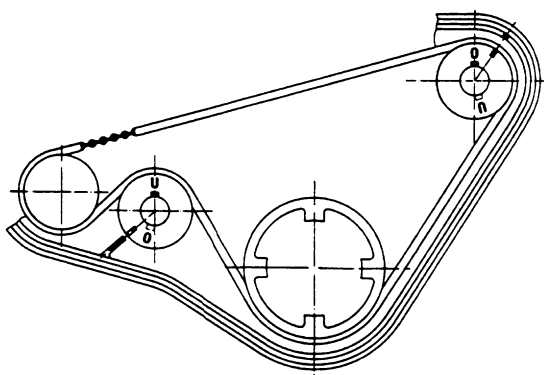

7. Prepare special tool P 9201 for testing. Pull out lockpin on special tool and push out gauge pin opposite the lockpin completely. Zero telltale needle.
8. Slide special tool on to belt. Push in gauge needle (arrow) until lockpin is heard to engage and read value from dial gauge.

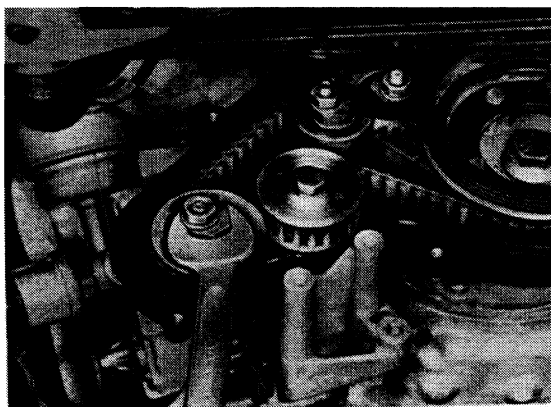

Note :

Always zero telltale needle on gauge after lockpin has engaged (turned anticlockwise) to exclude wrong gauge readings.

Specifications:

2.7 ± 0.3 dial value

If necessary, correct belt tightness.

10. After adjusting drive belt tension, adjust idler pulley. Use special tool 9207 or 0.5 mm feeler gauge so there is a clearance of 0.5 mm between drive belt and pulley when upper portion of drive belt is preloaded 0 to 1 mm (see sketch). Tighten idler pulley in this position. If correct gap cannot be reached, turn idler pulley 180 degrees and repeat adjustment. Tighten mounting nut to specified torque.

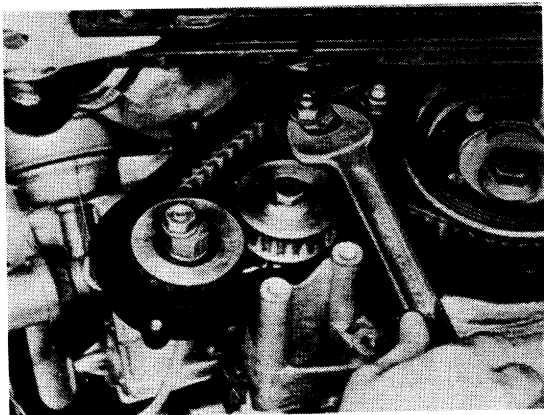

11. Install Poly-Rib belt and adjust; see page 13 - 1

Note:

Slides must make full-surface contact with belt.

While measuring, do not allow the Special Tool to turn or move on the belt.

TOOLS

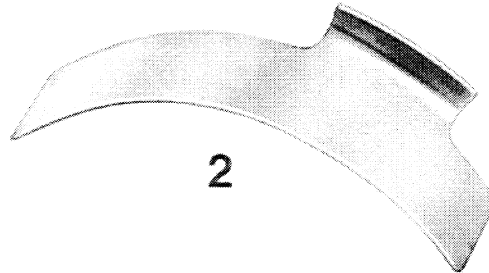
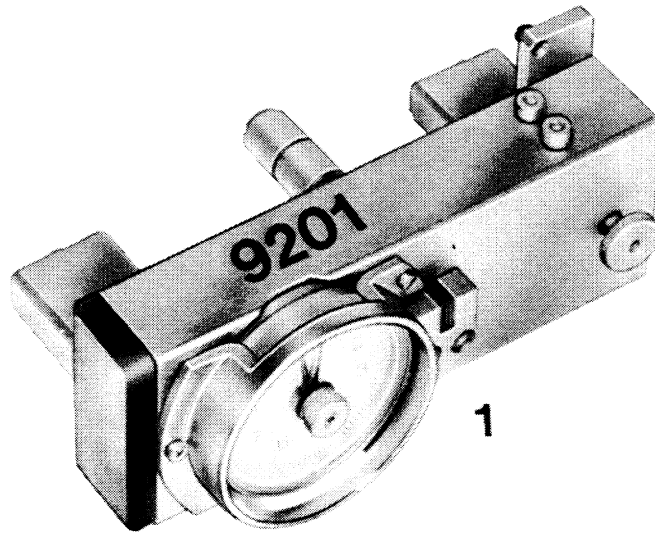

No.	Description	Special Tool	Remarks
1	Tester for belt tension	9201	
2	Gage	9207	
3	Wrench	9244	

CHECKING AND ADJUSTING TENSION OF DRIVE BELT FOR BALANCE SHAFTS (ROLLER WITH SLOT)

Note:

Do not check or adjust drive-belt tension unless engine is cold (at room temperature).

1. Remove air-cleaner assembly, unbolt and remove engine underguard.

4. Slacken pulley so that it no longer tensions drive belt.

2. Remove Poly-rib belt and servopump belt.

Note:

Always first loosen hex bolts of linkage slightly before unscrewing locknuts.

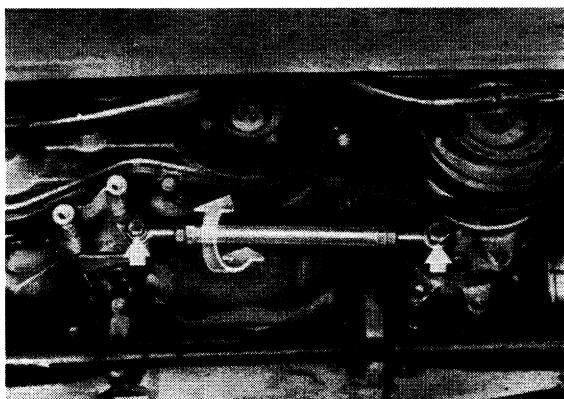

5a. Turn crankshaft clockwise until TDC mark on camshaft sprocket is aligned with mark on drive-belt cover.

3. Remove breather hose at top and remove drive-belt cover.



Illustration shows 16-VALVE ENGINE

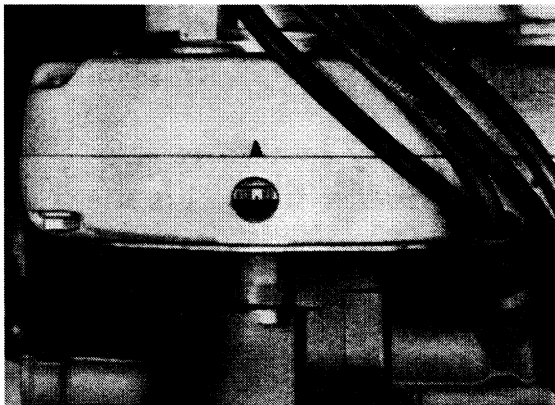

b. TDC mark on flywheel must also be aligned.

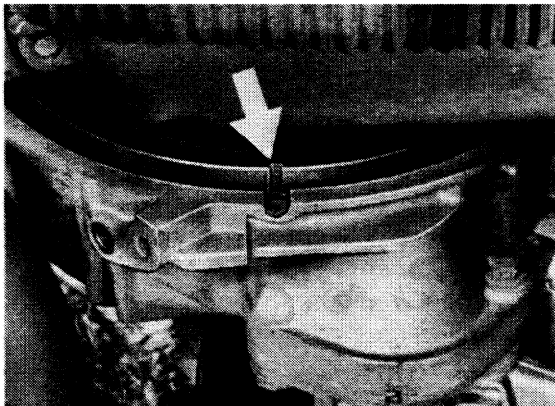

6. Check basic position of balance-shaft sprockets. Marks on sprockets must be aligned with marks on rear drive-belt cover.

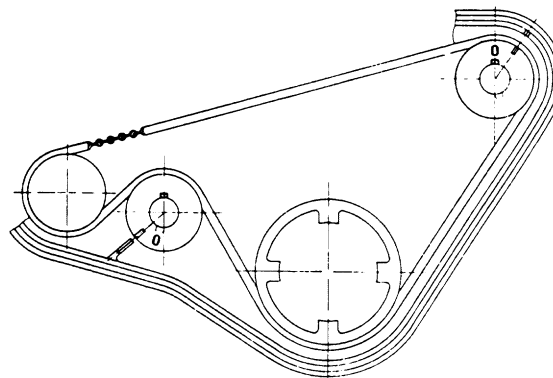

7. Prepare Special Tool 9201 for testing. Pull lockpin from Special Tool and push gage pin opposite lockpin out as far as it will go. Align telltale and measuring needles.

8. Slide Special Tool on to belt. Press measuring key (arrowed) in slowly until lockpin is heard to engage and read the value from dial gage.

Note:

To exclude errors in reading the gage, always align telltale needle and measuring needle once the lockpin is engaged (turn anticlockwise).

Specified value:

(new or used belt)
 2.7 ± 0.3 scale gradations

If necessary, correct belt tension.

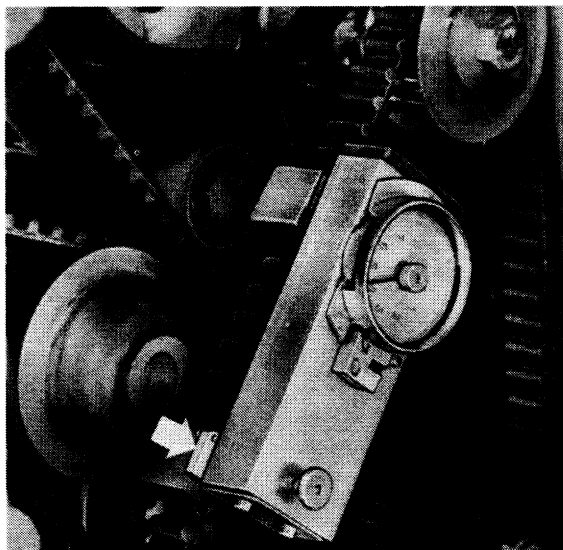
Adjusting

9. Turn tensioning roller clockwise to increase tension. Turn anti-clockwise to slacken. Tighten hex nut to 45 Nm (33 ftlb) while countering.

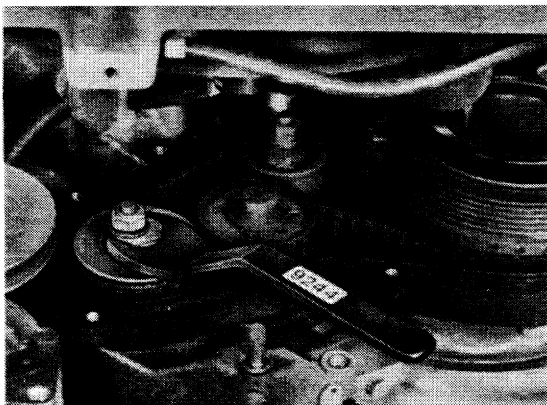

10. After adjusting drive-belt tension, adjust idler pulley. Using Special Tool 9207 or feeler gage (0.5 mm) set pulley so that there is a clearance of 0.5 mm between belt and pulley at the lower balance shaft when 0 to 1 mm pretension is applied to upper run of toothed belt. Tighten pulley in this position. If correct clearance cannot be reached, turn pulley through 180° and repeat adjustment. Tighten hex nut to 45 Nm (33 ftlb) while countering.

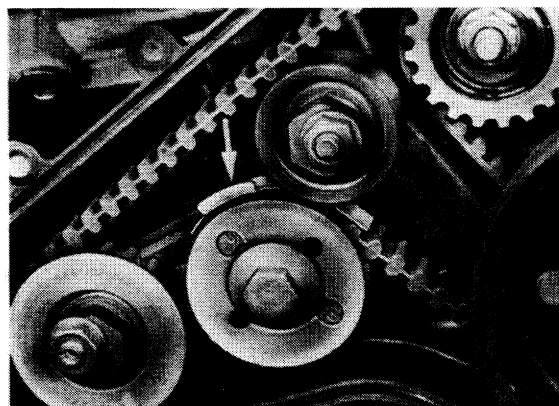

11. Install Poly-rib belt, servopump belt and adjust.

Note:

Slides must make full-surface
with contact belt.

While measuring, do not allow the
Special Tool to turn or move on
the belt.

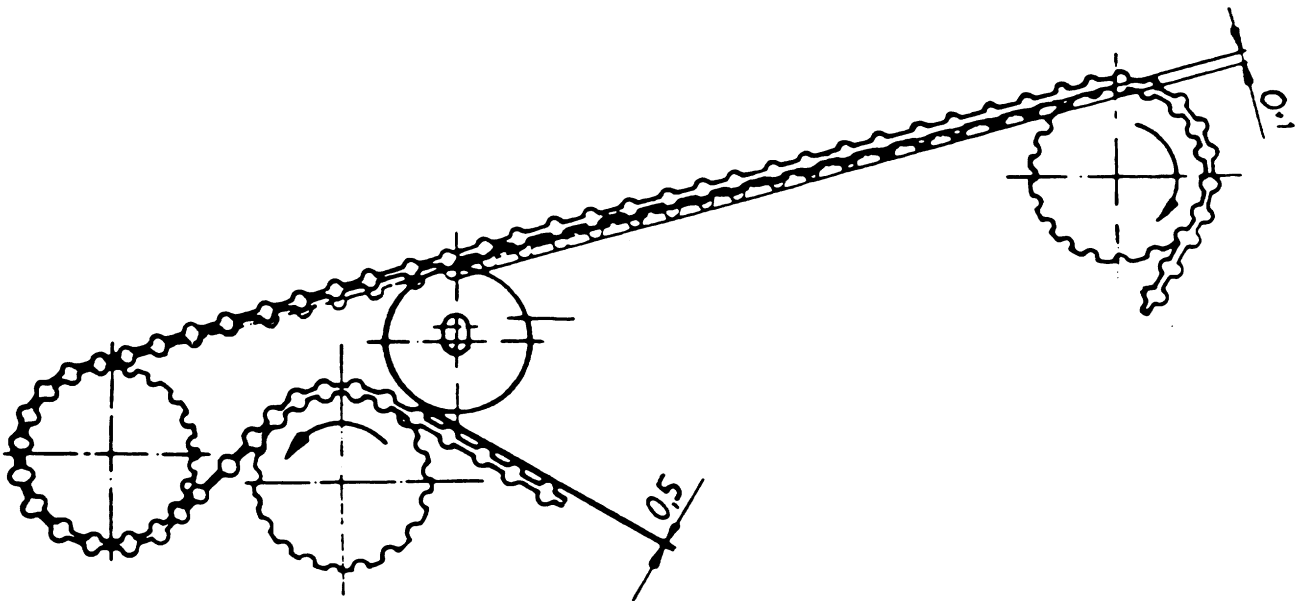

TOOLS

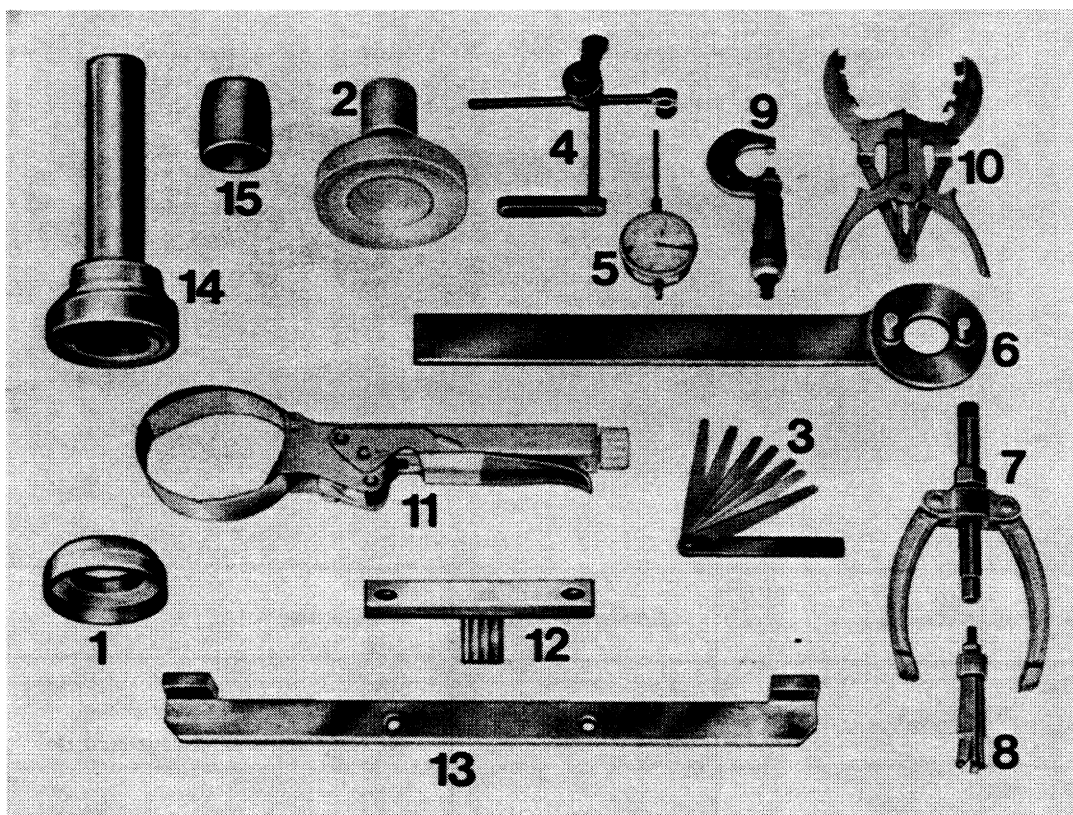

No.	Description	Special Tool	Remarks
1	Assembly sleeve	9203	
2	Pressure pad for crankshaft seal on flywheel end	9126	
3	Feeler gauge		standard tool
4	Dial gauge holder	VW 387	
5	Dial gauge	US 1026 or 1027	standard tool
6	Holding wrench	9200	
7	Support	US 1039	standard tool, e. g. Kukko
8	Internal claw puller	US 8028	Standard tool, e. g. Kukko No. 21/2 (14.5 to 18.5 mm)
9	Micrometer	US 1025	standard tool
10	Piston ring pliers	VW 121 b	standard tool, e. g. Hazet 790-1 a
11	Piston ring compressor	US 1008 a	standard tool, e. g. Hazet 794-U-3
12	Locking element	9206	
13	Flywheel holder	9130	
14	Pressure pad	9202	
15	Pipe	32-111	

TOOLS

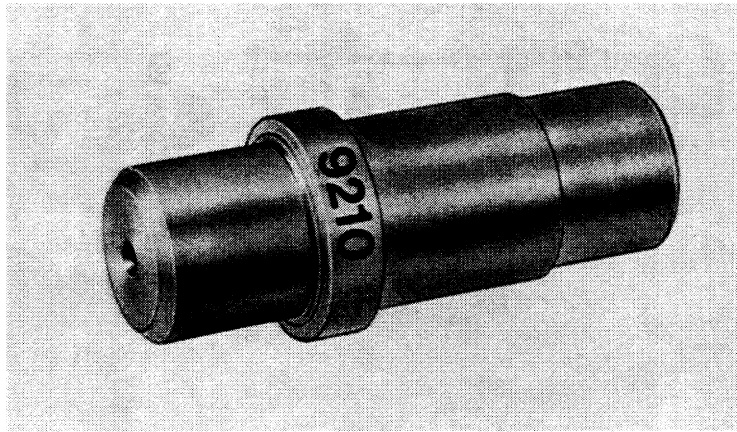

No.	Description	Special Tool	Remarks
	Thrust pad	9210	To install bearing sleeve for balance shaft bearing housing

Engine Assembly Support

Tools

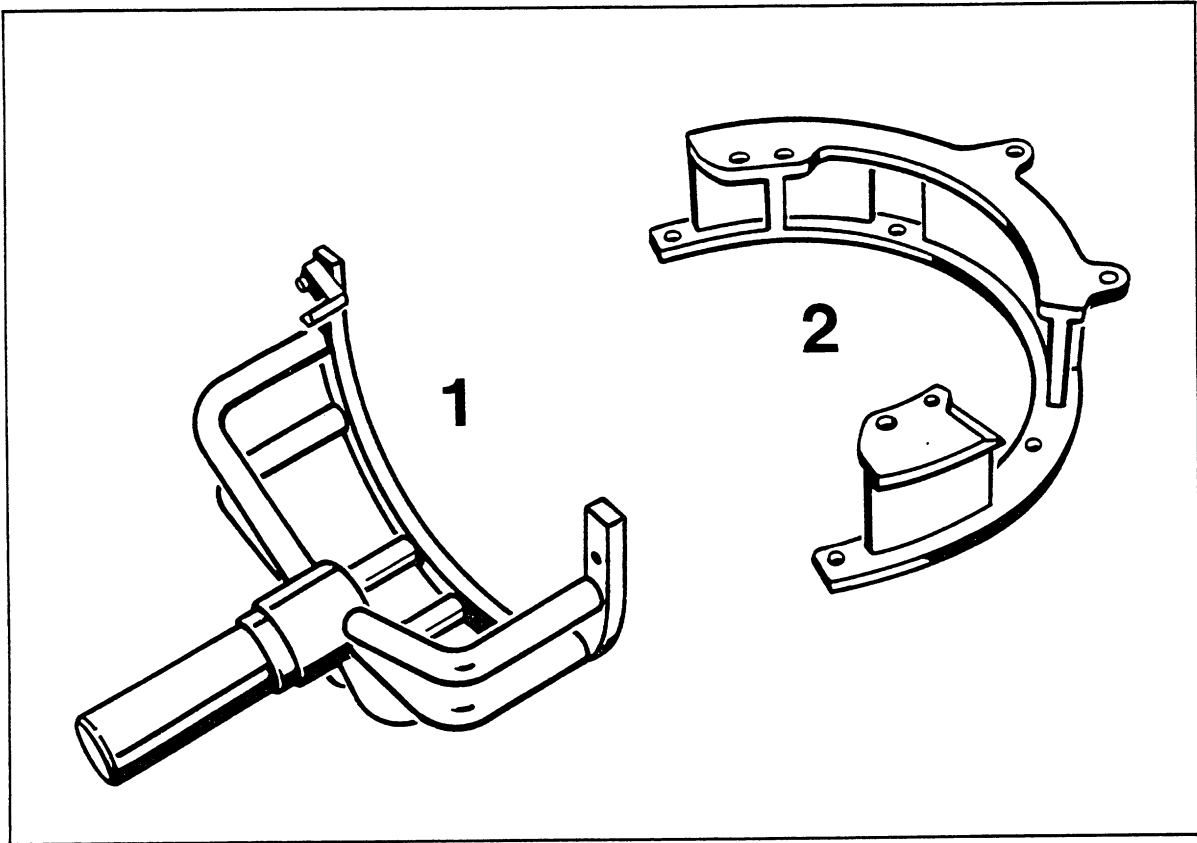

No.	Designation	Special Tool	Order number	Explanation
1	Engine support	9127	000.721.912.70	
2	Engine support adapter	9197	000.721.919.70	

Identification of engine number on crankcase

The engine number is stamped into the left-hand rear crankcase section (relative to direction of travel).

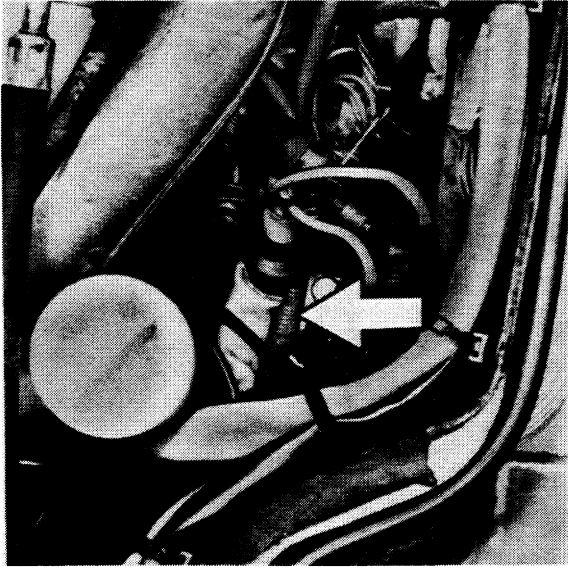

81/8080

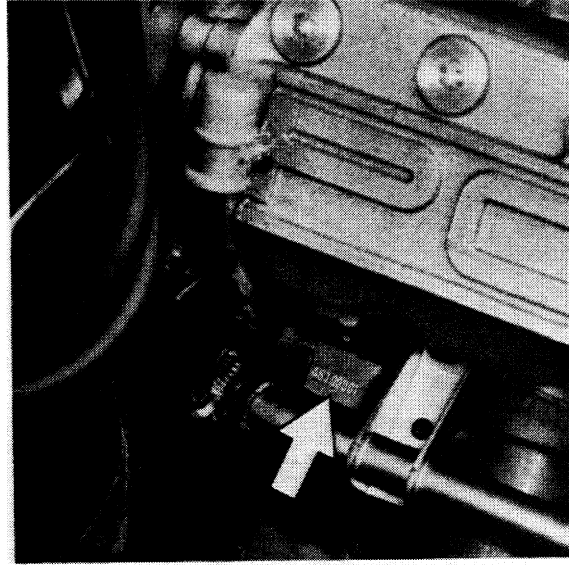

87/463

Tools

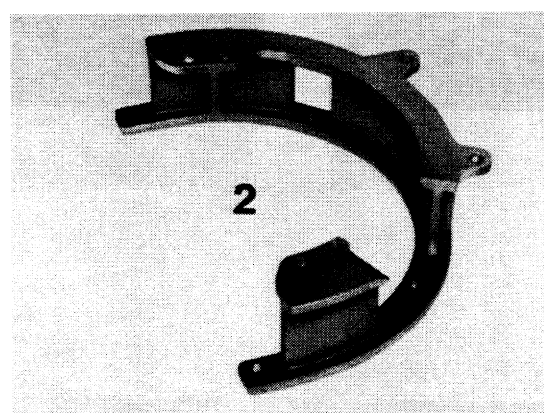
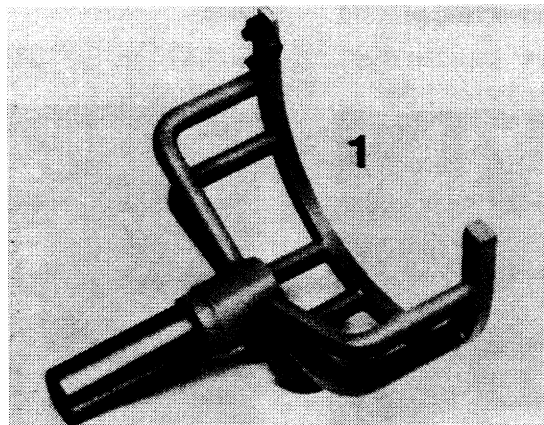

No.	Description	Special tool	Remark
1	Engine support	9127	
2	Engine support adapter	9197	

Crankcase identification - engine number

The engine number is embossed onto the rear left of the crankcase in the direction of travel.

As from Model 88, on the right-hand rear engine side.

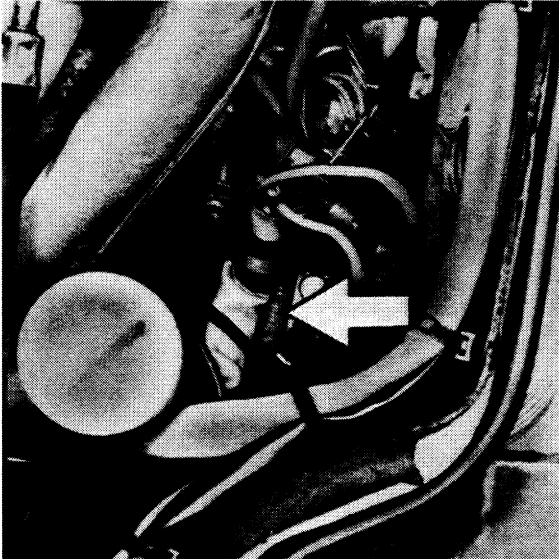

81/8080

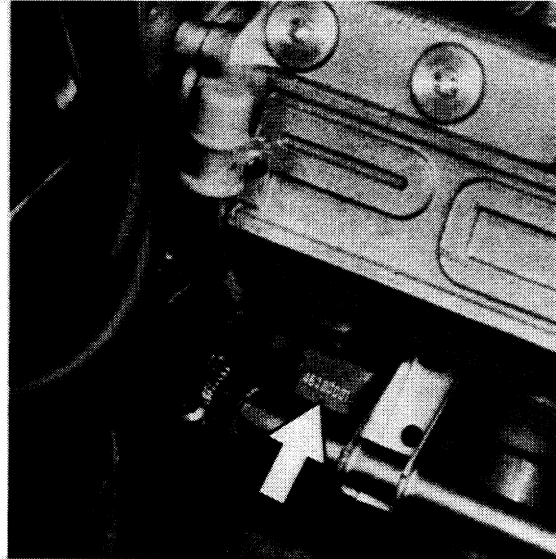

87/463

No.	Description	Qty.	Note When:		Special Instructions
			Removing	Installing	
1	Bolt	9		Torque: 90 Nm (65 ft lb)	
2	Flywheel	1			
3	Stud M 6 x 16 (reference mark sensor)	1			see page 13 - 24
4	Pin	1			
5	Shaft seal	1		Replace	see page 13 - 22
6	Pilot bearing	1			see page 13 - 23
7	Nut	1			
8	Plain washer A 6.4	1			
9	Bolt M 6 x 35	5			
10	Plain washer A 6.4	5			
11	Bolt M 8 x 55 for oil intake pipe	1			
12	Bolt M 8 x 50	6			
13	Washer	6			
14	Bolt M 8 x 50	1			
15	Nut M 10	7			
16	Washer	7		rounded side faces up	
17	Nut M 12 x 1.5	10		lettering faces up	
18	Washer	10		rounded side faces up	

No.	Description	Qty.	Note When:		Special Instructions
			Removing	Installing	
19	Crankcase lower section	1		Clean sealing surface and remove grease in area of oil intake and flywheel. Seal with Loctite 574	see page 13 - 21
20	Crankshaft	1		Check axial and radial play	see page 13 - 18
21	Closed main bearing no. 1	1		Make sure bearing engages in pin	
22	Main bearing no. 2	1			
23	Thrust bearing no. 3	1			
24	Main bearing no. 4	1			
25	Main bearing no. 5	1			
26	Crankcase upper section	1		Clean sealing surface and remove grease in area of oil intake and flywheel	see page 13 - 21

DISASSEMBLING AND ASSEMBLING CRANKCASE AND CRANKSHAFT SINCE 1985/2 MODELS

Main Bearing No. 1

The closed main bearing sleeve for bearing no. 1 now only has a lubricating groove around one half.

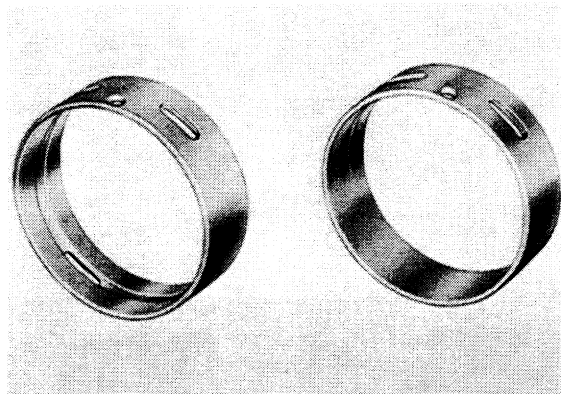

Old

New

Main Bearings No. 2, 4 and 5

The bottom halves of the bearings are designed without lubricating grooves. When installing it is important, that bearing shells w i t h lubricating grooves are placed in the upper crankcase section and bearing shells w i t h o u t lubricating grooves in the lower crankcase section.

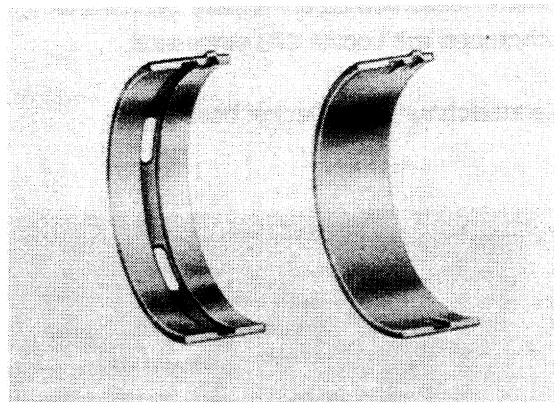

These bearing shells may also be used in engines before 1985/2 models.

Notes on assembly

Mount the cover of the centrifugal oil compartment in the upper part of the crankcase.

Model 89, 2.7 l
M 44/11/12

Note

It is not usually necessary to remove the cover when overhauling an engine. Should this be necessary, however, always heat the screw area with a hot-air blower. Hexagon head bolts fitted with Loctite 270.

Observe the marking on the cover.

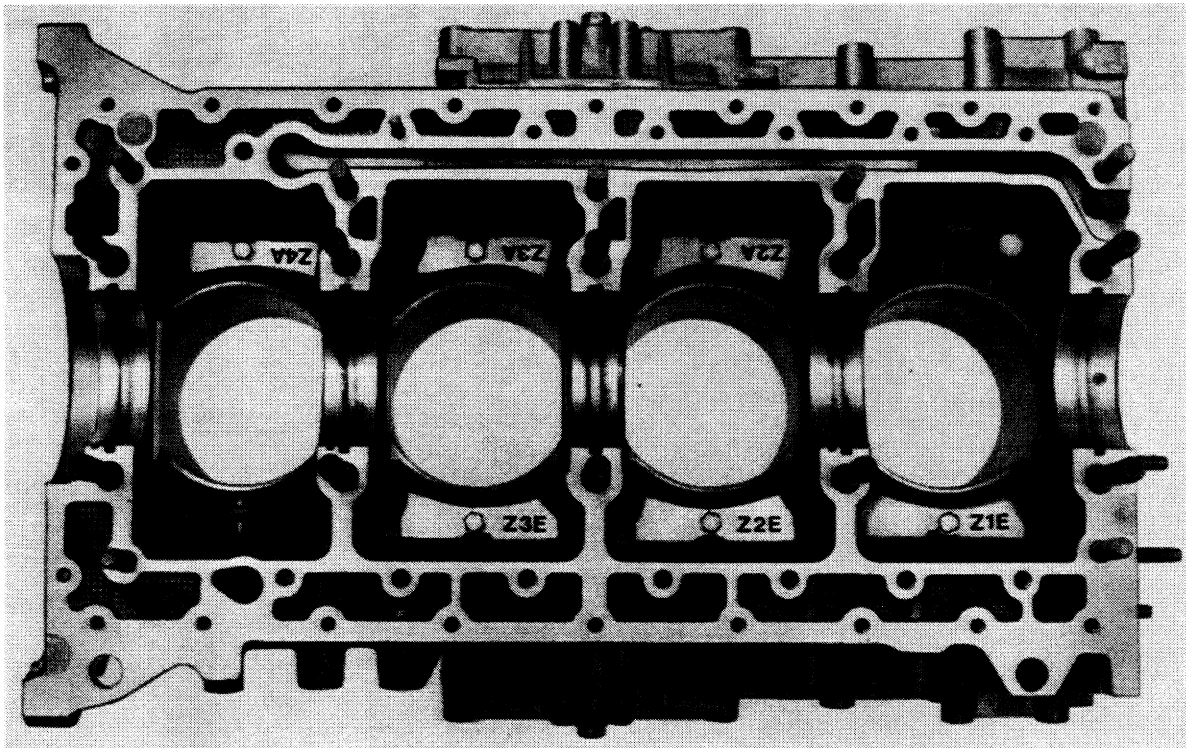

88/342

CHECKING CRANKSHAFT BEARING CLEARANCE

The "Plastigage" method is a simple way of checking bearing clearance.

Plastigage is available in three different sizes for measuring ranges from 0.025 to 0.23 mm.

Type	Color	Measuring Range
PG-1	green	0.025 to 0.075 mm
PR-1	red	0.05 to 0.15 mm
PB-1	blue	0.10 to 0.23 mm

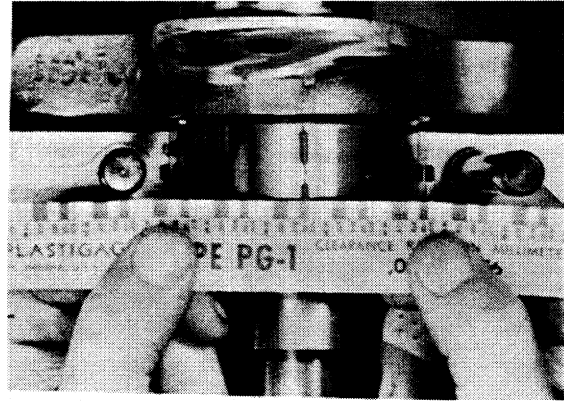

Checking Radial Clearance

1. Remove crankcase lower section.
2. Remove oil from bearing shell and bearing journal.
3. Place Plastigage having width of bearing on crankshaft journal in axial direction. Install crankcase lower section carefully and tighten to specified torque.

Note

Do not turn crankshaft while measuring.

4. Remove crankcase lower section. Read width of flattened Plastigage from measuring scale. Corresponding value on measuring scale equals the bearing clearance.

Play of new bearings: 0.020 to 0.098 mm
Wear limit: 0.16 mm

Checking Axial Clearance

Use Special Tool VW 387 to check axial clearance.

Play of new bearings: 0.110 to 0.312 mm
Wear limit: 0.40 mm

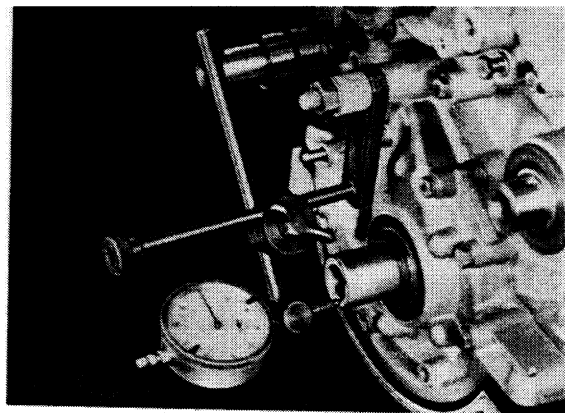

CODES OF CRANKCASE UPPER AND LOWER SECTIONS AS WELL AS BALANCE SHAFT COVER

1. Crankcase upper and lower sections as well as the balance shaft cover are machined together and must always be installed together. Check codes.

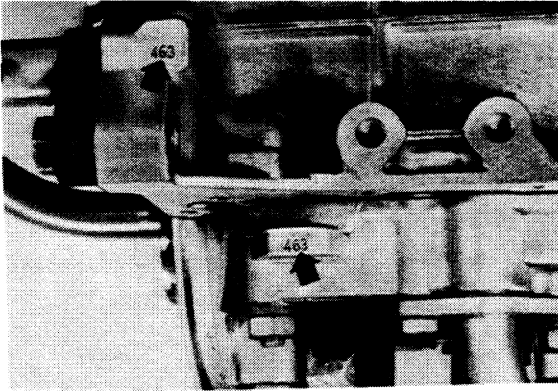

2. Codes of both balance shaft covers must be visible from above after installation.

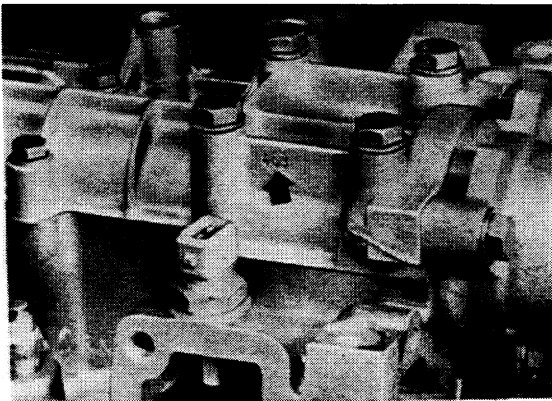

SEALING UPPER AND LOWER CRANKCASE SECTIONS

Note

Only Loctite 574 (orange) should be used as a sealant. Loctite 574 will dry only in conjunction with metal and exclusion of air. After applying a coat of sealant the bolts should be installed and tightened within 10 minutes, since the sealant on the metal will start to dry.

Removing Old Sealant

The old sealant does not have to be removed for repairs. It is only necessary to remove grease from the surface, so that after the cleaning solution has dried the new coat of sealant can be applied. The new Loctite will dissolve the old sealant in the surface finish and dry again after assembling.

We recommend a fine steel brush or Loctite 80646 adhesive remover for removing old sealant, if this is ever necessary.

Applying Sealant

1. We recommend a short-pile velour roller for application by hand. A tray will also be required for the sealant and should have a raised section to squeeze excess sealant from the roller.
2. Roll on a very thin coat of sealant with a velour roller.

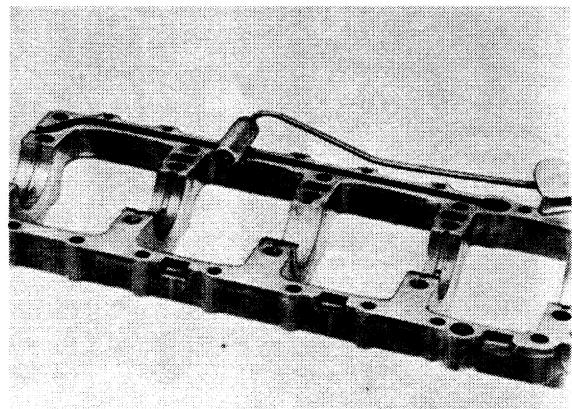
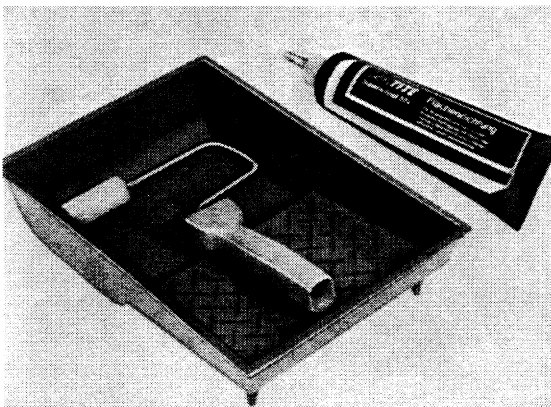

INSTALLING UPPER AND LOWER CRANKCASE SECTIONS

1. Coat lower crankcase section with Loctite 574 in areas of oil intake and sealing surface in areas of flywheel.

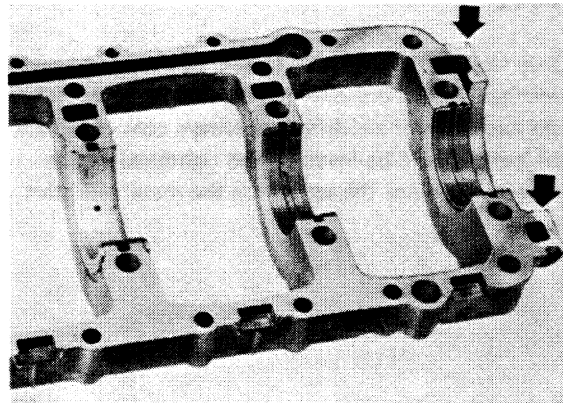
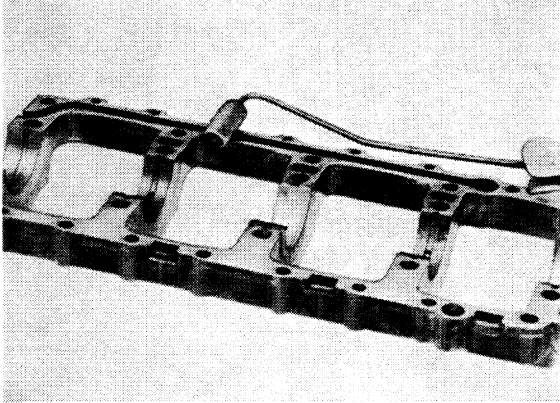

2. Install lower crankcase section.
See page 10-03 for tightening procedures.
Order for tightening:

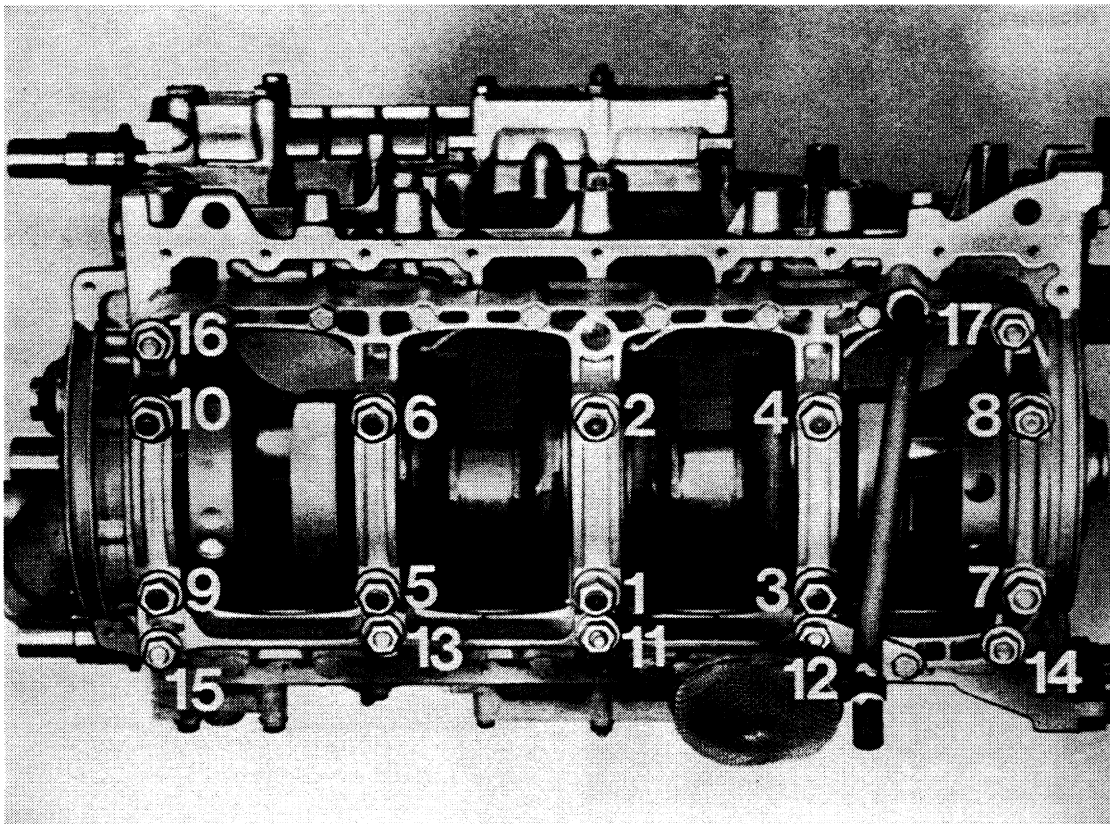

INSTALLING CRANKSHAFT OIL SEAL (FLYWHEEL END)

1. Lubricate sealing lip with oil and slide oil seal over Special Tool 9203 on to crankshaft.

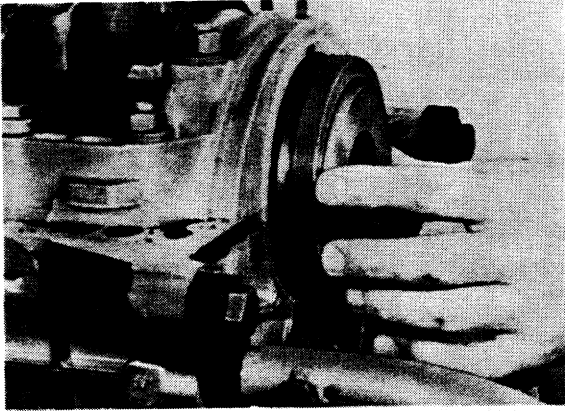

2. Remove special tool and drive in oil seal against stop with Special Tool 9126.

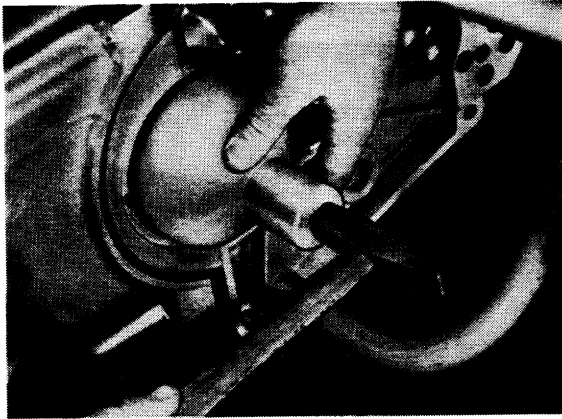

REMOVING AND INSTALLING FLYWHEEL**Removing**

Mount Special Tool 9130 on flywheel with two hex head bolts and loosen socket head bolts.

Installing

Torque socket head bolts to 90 Nm (65 ft lb).

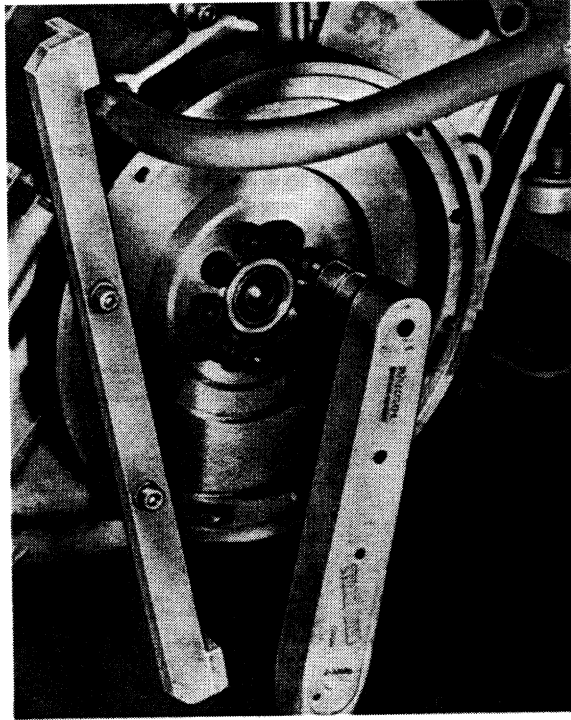
**REMOVING AND INSTALLING PILOT BEARING****Removing**

Pull out pilot bearing with an internal extractor, e. g. Kukko 21/2 (14.5 to 18.5 mm).

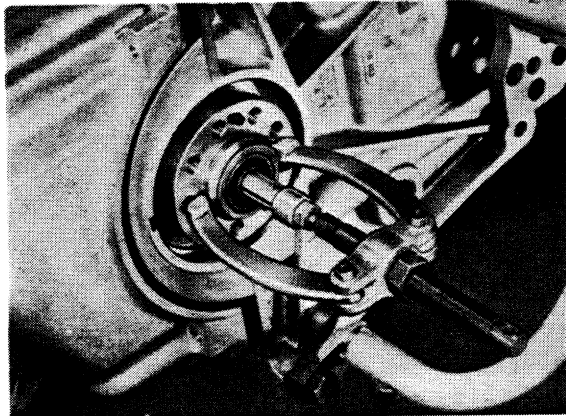
**Installing**

Drive in bearing against stop with Special Tool VW 32-111.

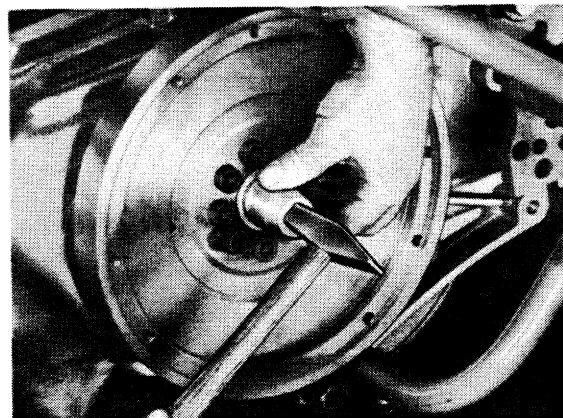

REPLACING STUD (REFERENCE MARK SENSOR)

1. Heat stud locally to about 200 °C (400 °F) to unseal Loctite 270. Unscrew stud.
2. Screw in new stud with Loctite 270 and adjust to 5 ± 0.1 mm.

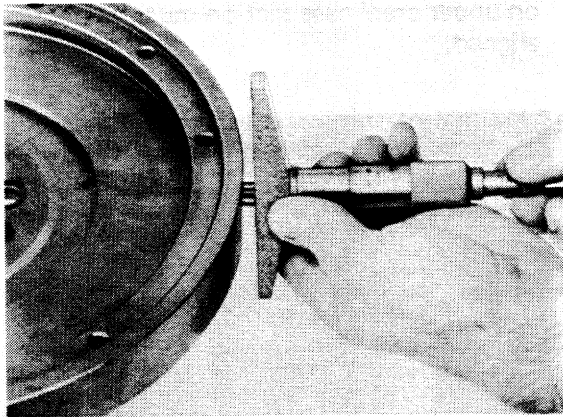

SETTING CRANKSHAFT TO TDC IN CYLINDER NO. 1

Crankshaft Position (Engine Installed)

TDC mark on flywheel and cast boss on clutch housing must be aligned.

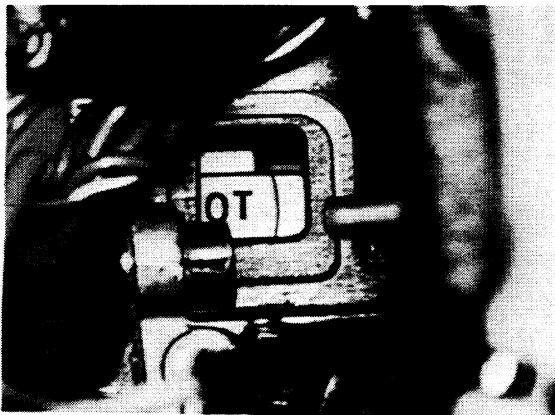

Additional TDC mark on flywheel, seen from underneath car. TDC is reached, if the approx. 5 mm wide groove in the flywheel is in the middle of the opening of the clutch housing.

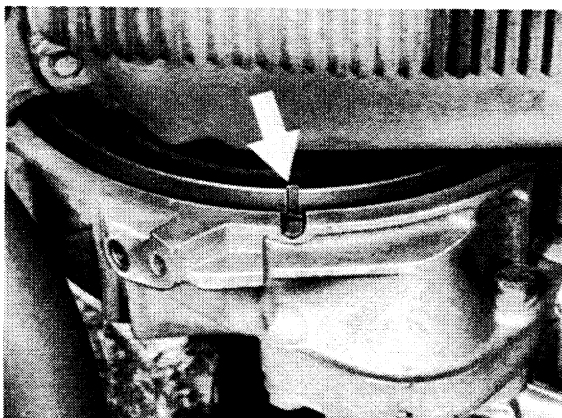

Crankshaft Position (Engine Removed)

TDC mark on flywheel and cast mark on upper crankcase section must be aligned.

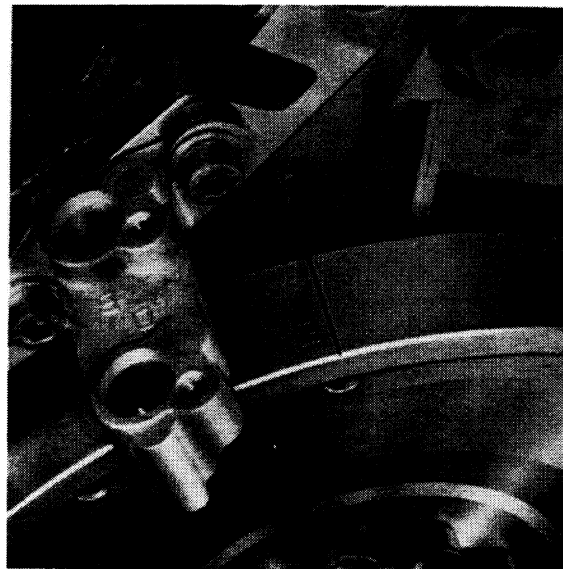

Notes on assembly

Aligning the upper and lower parts of the crankcase.

Note

When assembling, make sure that there is no offset between the crankcase halves on the facing surface (on the oil pump side).

1. Using a plastic hammer, align the slightly tightened lower part of the crankcase (tightening torque 10 - 20 Nm) with the upper part of the crankcase. Carry out the finger-nail test at the joint.
2. Tighten the crankcase with the specified tightening torque (3 stages).

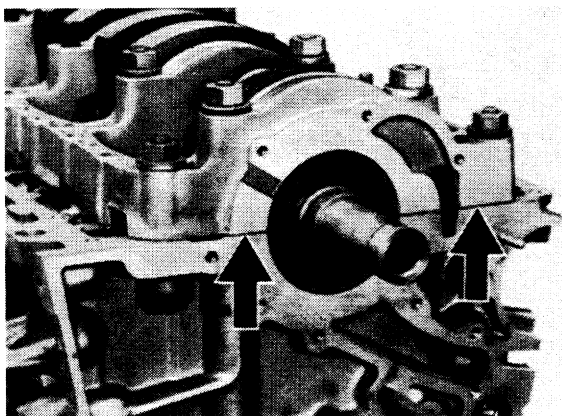

88/343

3. Smooth any slight remaining offset at the joint with oil stone.

Flywheel, removing and installing

Removing

Fasten bracket Special Tool 9130 to the flywheel with two hexagon head screws and undo the screws with internal serrations

Installing

Tighten the screws with internal serrations in 2 stages.

1st stage	40 Nm
2nd stage	90 Nm

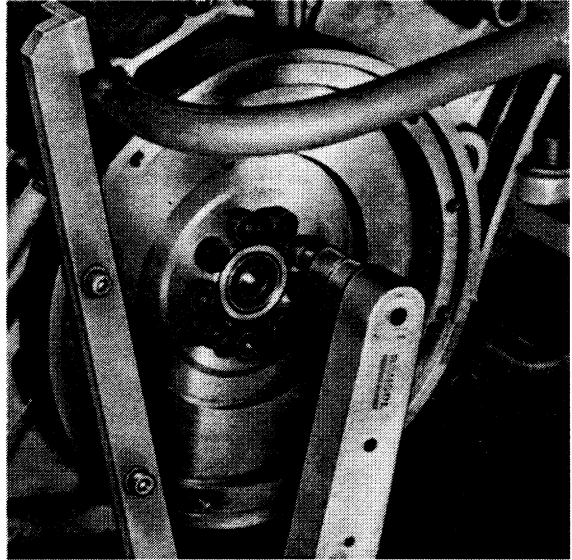

8485

Grooved ball bearing, removing and installing

Removing

Pull out grooved ball bearing with internal puller, e.g. Kukko 21/2 (14.5 to 18.5 mm)

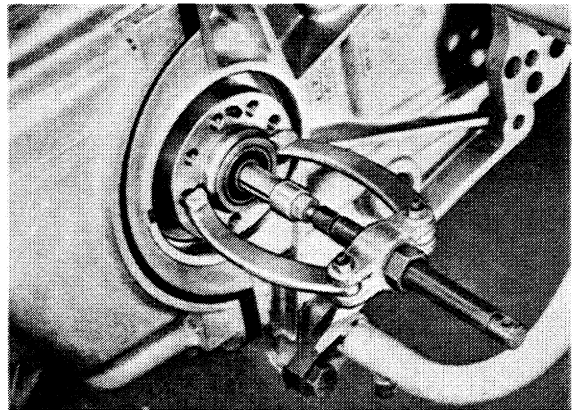

8490

Installing

Drive into position with tube, Special Tool VW 32-111.

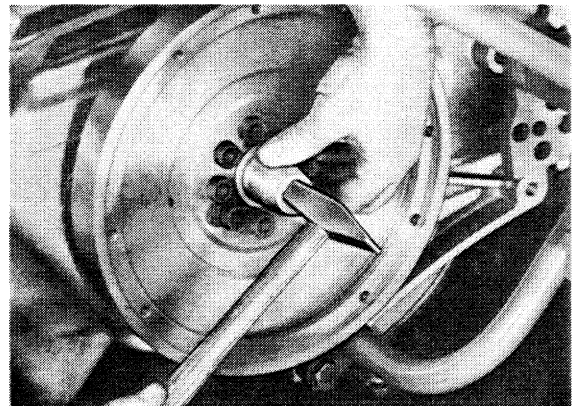

8496

Refacing the flywheel

If severe score or burning marks are evident on the flywheel, the clutch disc mating surface on the flywheel maybe refaced on a lathe.

Remove as little material as possible.

Wear limit for flywheel thickness 11.8 mm.

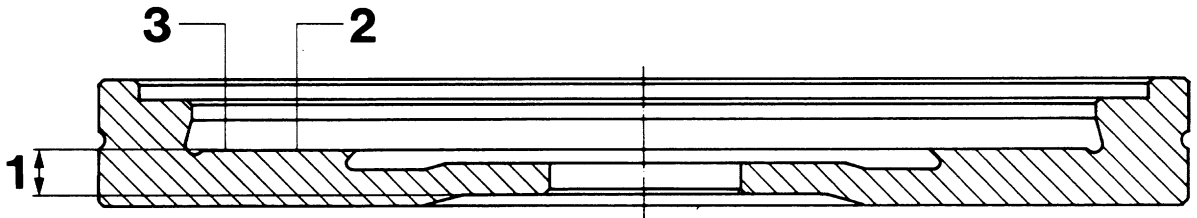

728/13

1 Wear limit 11.8 mm

2 Remove as little material as possible

3 Max. runout 0.05 mm

Note for refacing the mating surface:

Surf. roughness + unevenness = 0.008 mm

Checking pistons and cylinder bores

Motortype M 44.01...10 (2,5 l)

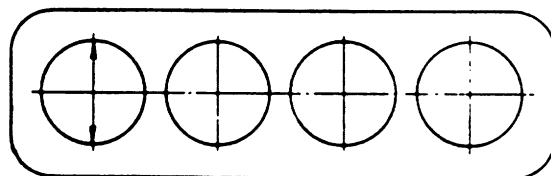
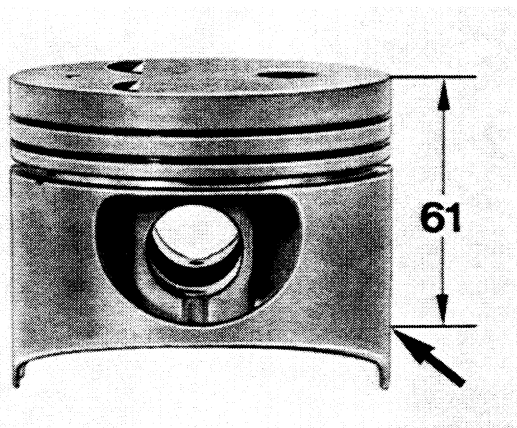

Repair Stage	Piston Ø (mm) Fa. Mahle	Piston Ø (mm) Fa. Kolbenschmidt	Cylinder bore dia. (mm)	tolerance group code
Standard size	99,980	99,980	100,000	0
	99,990 ± 0,005	99,990 ± 0,007	100,010 ± 0,005	1
	100,000	100,000	100,020	2
Oversize 1	100,480	100,480	100,500	I 0
	100,490 ± 0,007	100,490 ± 0,007	100,510 ± 0,005	I 1
	100,500	100,500	100,520	I 2

Checking pistons

Measure approx. 61 mm from piston crown, 90° offset from piston pin axis.

Checking cylinder bores

Measure approx. 61 mm from upper edge of cylinder bore, transverse to engine block. Mount lower crankcase section and tighten bolts to specified torque for measuring.

Note

It is recommended that the stocks of the relevant tolerance group are checked before machining the cylinders. If necessary, hone to the piston size available.

In some cases, certain tolerance groups may be in short supply.

Pistons, disassembling and assembling con rods

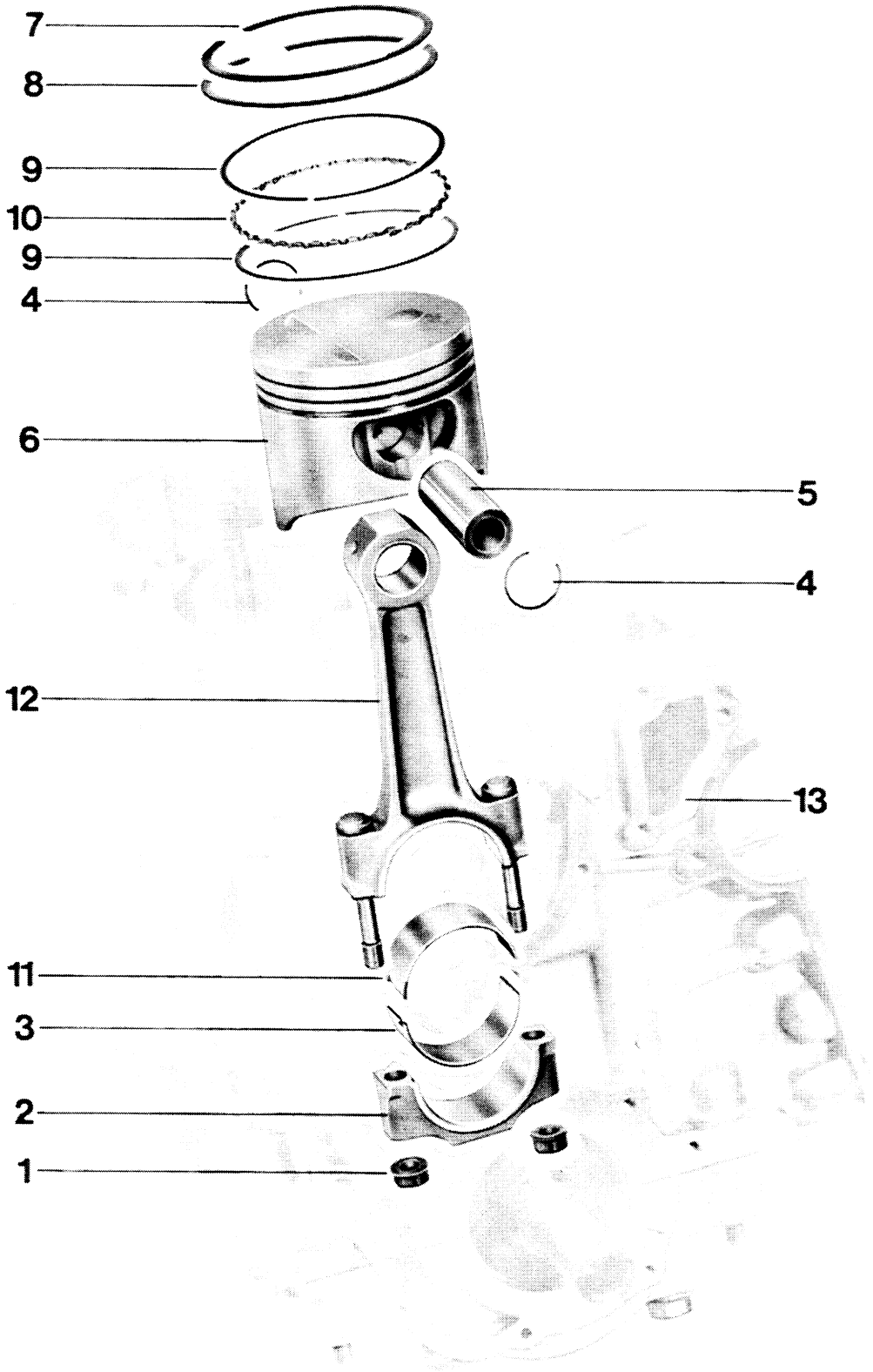

No.	Description	Qty.	Note when:	
			Removing	Installing
1	Connecting rod nut	8		Replace, tighten to specified torque. Lubricate threads and bearing surface
2	Connecting rod cap	4		Pay attention to pair numbers
3	Lower bearing shell half	4		Always renew worn bearing shells
4	Circlip	8	Pry out	Position correctly
5	Piston pin	4		
6	Piston	4		Give light coat of oil; position correctly; note tolerance group
7	Piston ring Groove 1 Tapered face	4		
8	Piston ring Groove 2 Tapered face scraper ring	4		
9	Oil scraper ring Groove 3	8		
10	Spring Groove 3	4		First install spring; after installing oil scraper rings check whether end gaps of springs are offset

No.	Description	Qty.	Note when:	
			Removing	Installing
11	Upper conrod bearing shell half	4		Always renew worn bearing shells
12	Connecting rod with conrod bolts	4		
13	Upper crankcase section	1		Check cylinder bores after mounting lower crankcase section and tightening bolts to specified torque

PISTON SURVEY

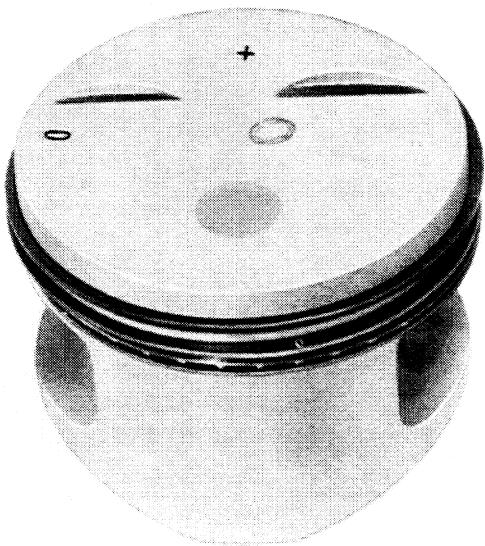

Europe and Rest of World



USA, Canada, Japan

INSTALLING PISTON AND CONNECTING ROD

Connecting Rod

The material of connecting rods was changed since February, 1984. This did not change the weight. New and old connecting rods can be installed together in one engine.

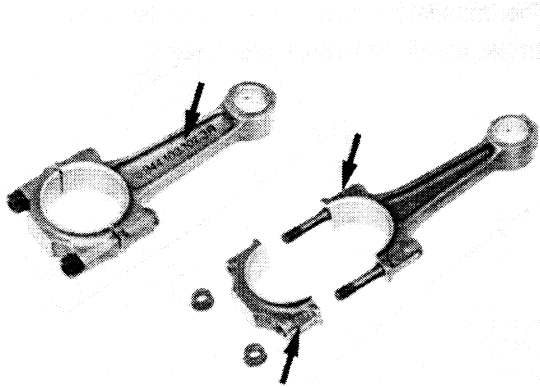

Old

Sintered connecting rod, Part No. 944 103 001 00 (rough part number on inside of conrod shaft).

New

Cast connecting rod, Part No. 944 103 001 01 (rough part number reduced on both sides on conrod base and conrod cap).

Connecting Rod Nuts

The bearing surface of conrod nuts was also changed due to the connecting rod material change.

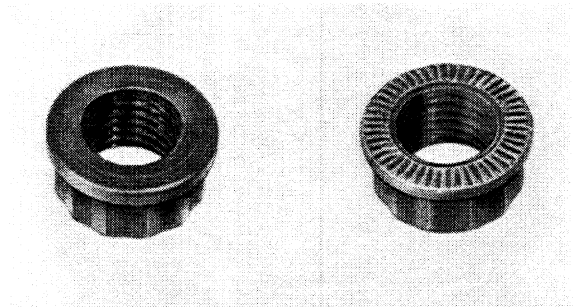

Old

Smooth bearing surface, Part No. 928 103 172 01.

New

Ribbed bearing surface, Part No. 928 103 172 02.

After depletion of stocks, only the new version (ribbed bearing surface) conrod nuts will be available.

Note

The old (smooth) conrod nuts must never be used with the new cast connecting rods.

It is recommended to use the new connecting rod nuts each time the engine is repaired. Tightening torque: 75 Nm.

The tightening torque of 57 + 5 Nm is still applicable to smooth connecting rod nuts used together with sintered steel connecting rods.

Pistons from Model 89 onward

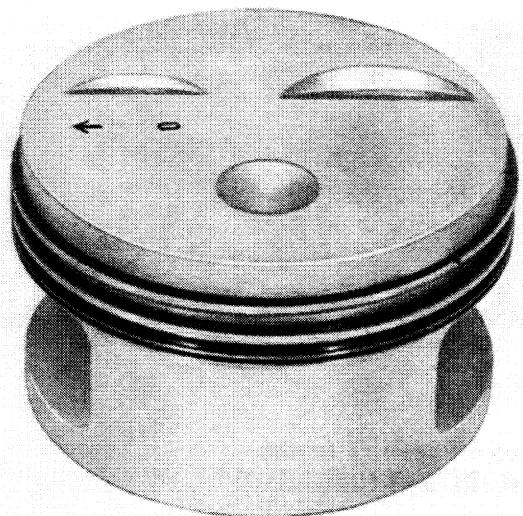

Engine M 44. 11/12 (2,7 l) worldwide

Compression ratio: 10.9 : 1

Nominal Ø 104.00 mm

The installation position is indicated by an arrow pointing towards the pulley.

Checking pistons and cylinder bore

Engine type M 44.11/12 (2,7 l)

Repairsize	Piston Ø (mm) Fa. MAHLE	Cylinder bore (mm)	tolerance group code
Standard size	103.980	104.000	0
	103.990 ± 0.007	104.010 ± 0.005	1
	104.000	104.020	2
Oversize 1	104.480	104.500	1 0
	104.490 ± 0.007	104.510 ± 0.005	1 1
	104.500	104.520	1 2

Checking pistons

Measure approx. 57 mm from base of piston, 90° offset to axis of piston bolt.

Checking cylinder bores

Measure approx. 57 mm from top edge of cylinder bore, across cylinder block. For measurement, mount lower crankcase section and tighten with prescribed tightening torque

Note

If recommended that the stocks of the relevant tolerance group are checked before machining the cylinders. If necessary, hone to the piston size available.

In some cases, certain tolerance groups may be in short supply.

No.	Description	Qty.	Note When:		Special Instructions
			Removing	Installing	
1	Bolt M 10 x 35	1		Coat threads with Loctite 574 Torque: 45 Nm. Hold with Special Tool 9200	
2	Washer	1		Position correctly	
3	Collar	1		Position correctly; "O" and "U" must be seen in large bores	Code "U" deleted since 1984 model, see page 13 - 50 (USA page 13 - 46)
4	Drive gear for compensating shaft	1		Check movement on seat of compensating shaft, machining if necessary. Give seat a light coat of Optimoly HT	
5	Woodruff key	1			
6	Bolt M 8 x 35	3			
7	Plain washer A 8.4	3			
8	Upper bearing housing	1			
8 a	Sleeve	1			see Page 13-42 (USA Page 13-38)
9	Shaft seal 30 x 47	1		Replace and lubricate sealing lip with oil	

No.	Description	Qty.	Note When:		Special Instructions
			Removing	Installing	
10	Spacer	1			
11	Gasket	1		Replace and position correctly	
12	O-ring	1		Replace and give light coat of oil	
13	Bolt M 8 x 55	4			
14	Plain washer A 8.4	4			
15	Bolt M 6 x 50	4			
16	Plain washer A 6.4	4			
17	Nut on stud M 8	2			
18	Plain washer A 8.4	2			
19	Bolt M 6 x 30	2			
20	Plain washer A 6.4	2			
21	Upper compensating shaft housing	1	If necessary, heat housing cover with hot air blower to melt sealant. Remove remainders of Loctite with Loctite 60646 adhesive remover	Roll Loctite 638 on sealing surface with a velour roller. Note tightening procedures	see page 13 - 43 (USA page 13 - 39)

No.	Description	Qty.	Note When:		Special Instructions
			Removing	Installing	
22	Upper compensating shaft	1			
23	End ring	1			
24	Seal	1		Replace	
25	Bearing shell	2		Position correctly	
26	Bolt M 10 x 35			Coat threads with Loctite 574 Torque: 45 Nm. Hold with Special Tool 9200	
27	Washer	1		Position correctly	
28	Collar	1		Position correctly; "O" and "U" must be seen in large bores	Code "U" deleted since 1984 model, see page 13 - 50 (USA page 13 - 46)
29	Drive gear for compensating shaft	1		Check movement on seat of compensating shaft and machine, if necessary. Give seat a thin coat of Optimoly HT	
30	Woodruff key	1			
31	Bolt M 8 x 50	3			
32	Plain washer A 8.4	3			

No.	Description	Qty.	Note When:		Special Instructions
			Removing	Installing	
33	Lower bearing housing	1			
34	Shaft seal 30 x 48	1		Replace and lubricate sealing lip with oil	
35	Spacer	1			
36	Gasket	1		Replace	
37	O-ring	1		Replace and give light coat of oil	

REPLACING BEARING SLEEVE FOR COMPENSATING SHAFT BEARING HOUSING

Removing

Press out sleeve with Special Tool 9210.

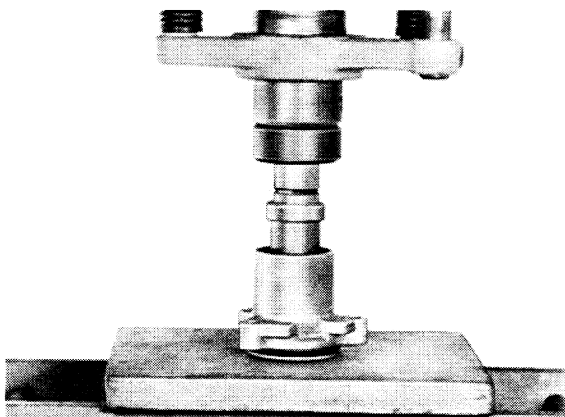

Installing

Press in sleeve against stop with Special Tool 9210.

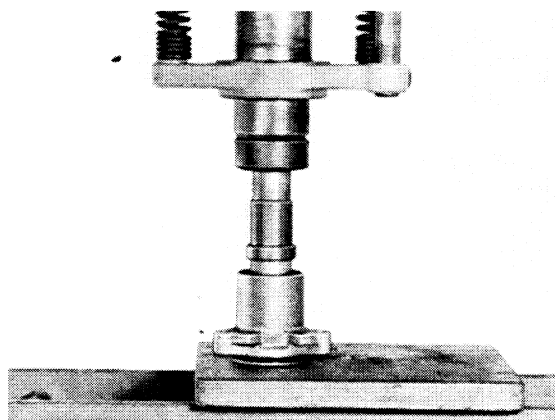

TIGHTENING PROCEDURES FOR CRANKCASE UPPER SECTION ON BALANCE SHAFT HOUSING

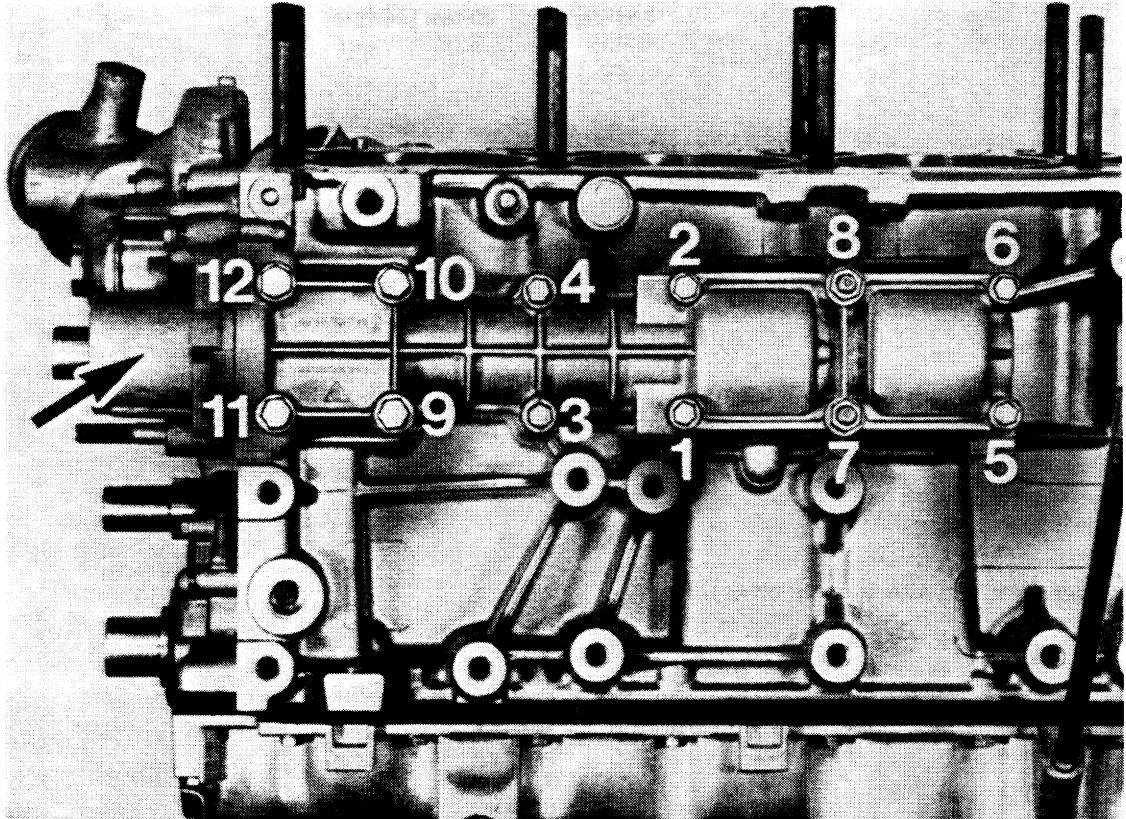

Note

Crankcase upper section and balance shaft housing must be aligned with each other as described below.

1. Tighten all hexagon head bolts and hexagon nuts finger tight.
2. Mount bearing housing with a lightly oiled O-ring, but without tightening the mounting bolts.

3. TIGHTENING SPECIFICATIONS:

Bolts	M 6			8 Nm (6 ft lb)
Nuts on studs	M 8	2 steps:	1st step	15 Nm (11 ft lb)
			2nd step	30 Nm (22 ft lb)
Bolts	M 8	2 steps:	1st step	15 Nm (11 ft lb)
			2nd step	20 Nm (14 ft lb)

Note

Check movement of balance shaft between each tightening step.

INSTALLING SHAFT SEALS OF BEARING HOUSING

Note

Seals deviate among each other in diameter and on the sealing lip.

Code (arrow) faces in turning direction of balance shafts.

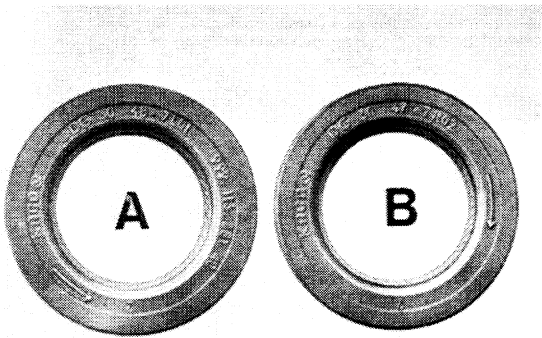

"A" Seal of lower
balance shaft

"B" Seal of upper
balance shaft

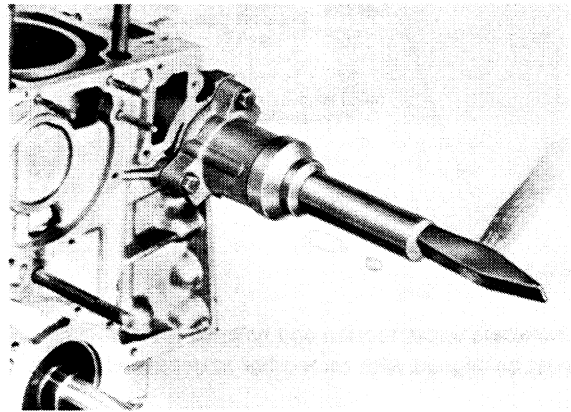

Lubricate sealing lips with oil and at same time install with spacer. Then drive in with Special Tool 9202.

INSTALLING DRIVE GEARS OF BALANCE SHAFTS

Note

Drive shafts are identical parts.

Installing Drive Gear of Upper Balance Shaft

1. Woodruff key groove of balance shaft faces up.
2. Push drive gear with groove code "O" on woodruff key.

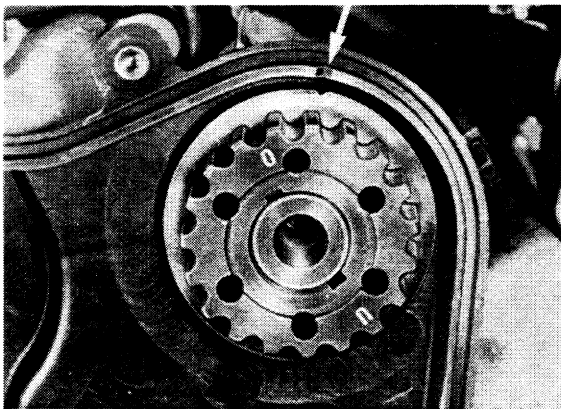

Mounting Drive Gear

1. Install bolt, washer and collar.
2. Align collar that codes "O" and "U" can be seen in large bores.

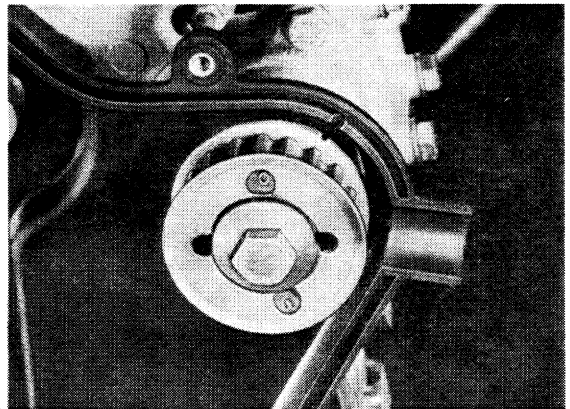

Installing Drive Gear of Lower Balance Shaft

1. Woodruff key groove of balance shaft faces up.
2. Push drive gear with groove code "U" on woodruff key.

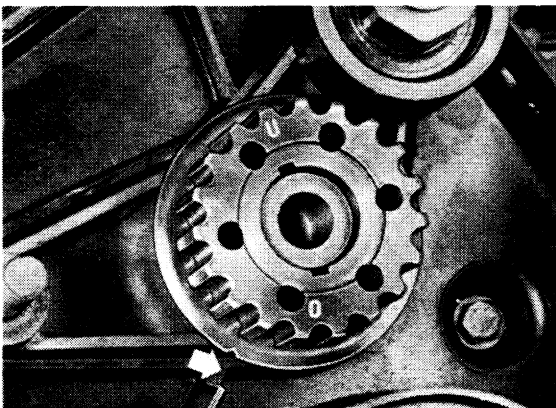

3. Tighten bolt while holding with Special Tool 9200.

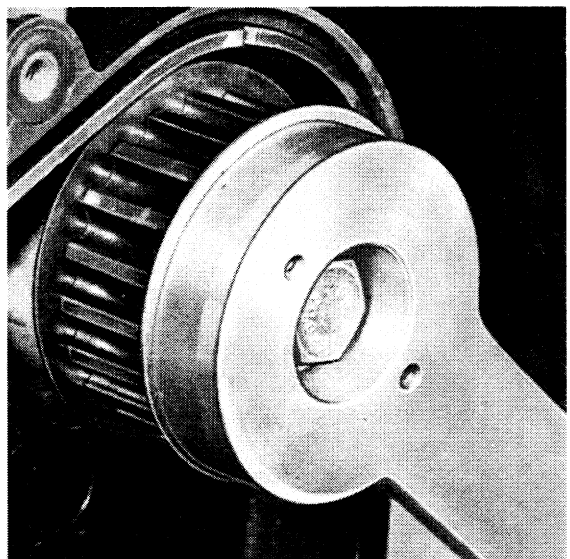

DISASSEMBLING AND ASSEMBLING BALANCE SHAFT DRIVE

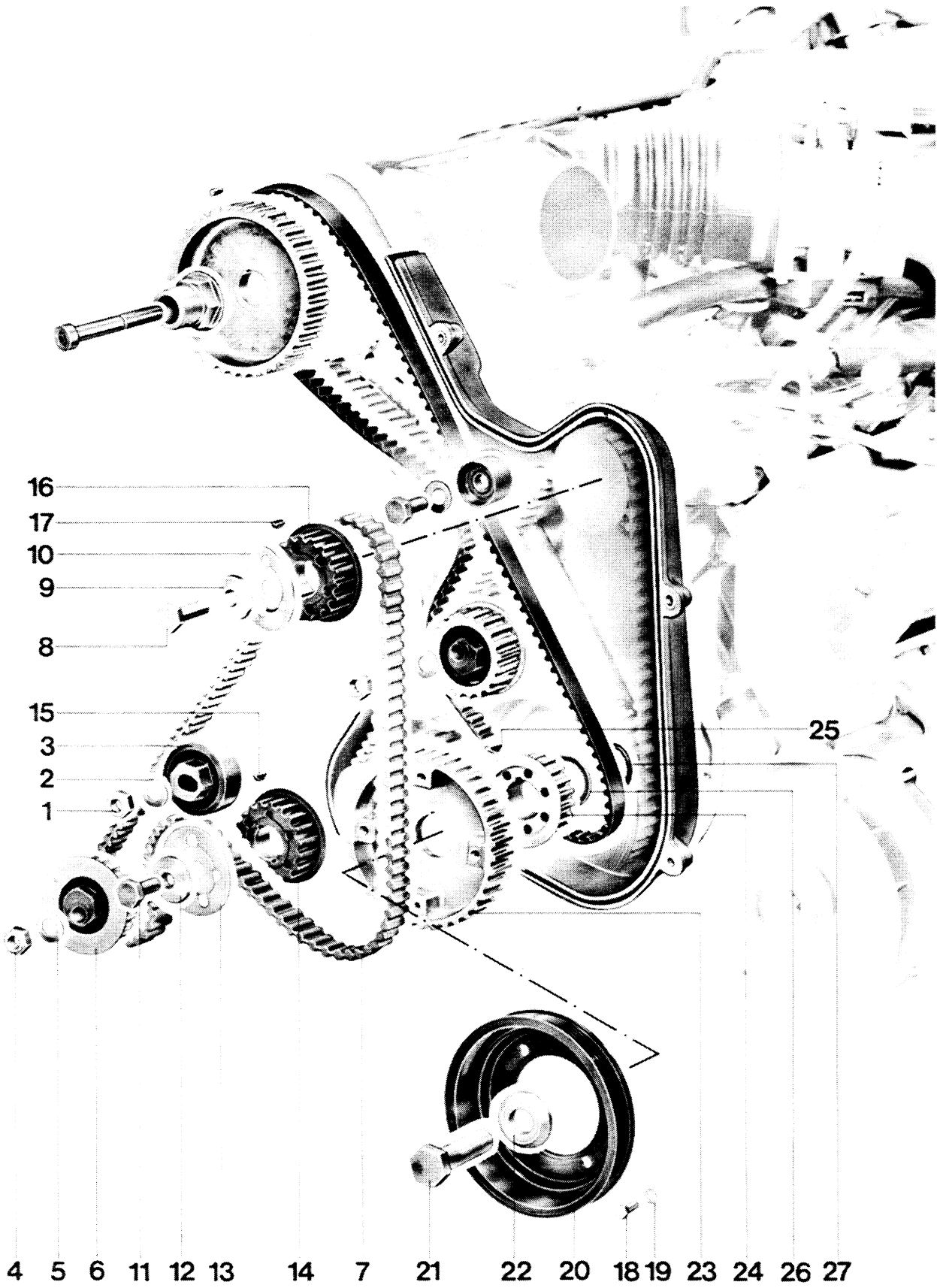

DISASSEMBLING AND ASSEMBLING COMPENSATING SHAFT DRIVE
SINCE 1985/2 MODELS

Compensating Shafts with Separate Bearing Bridges

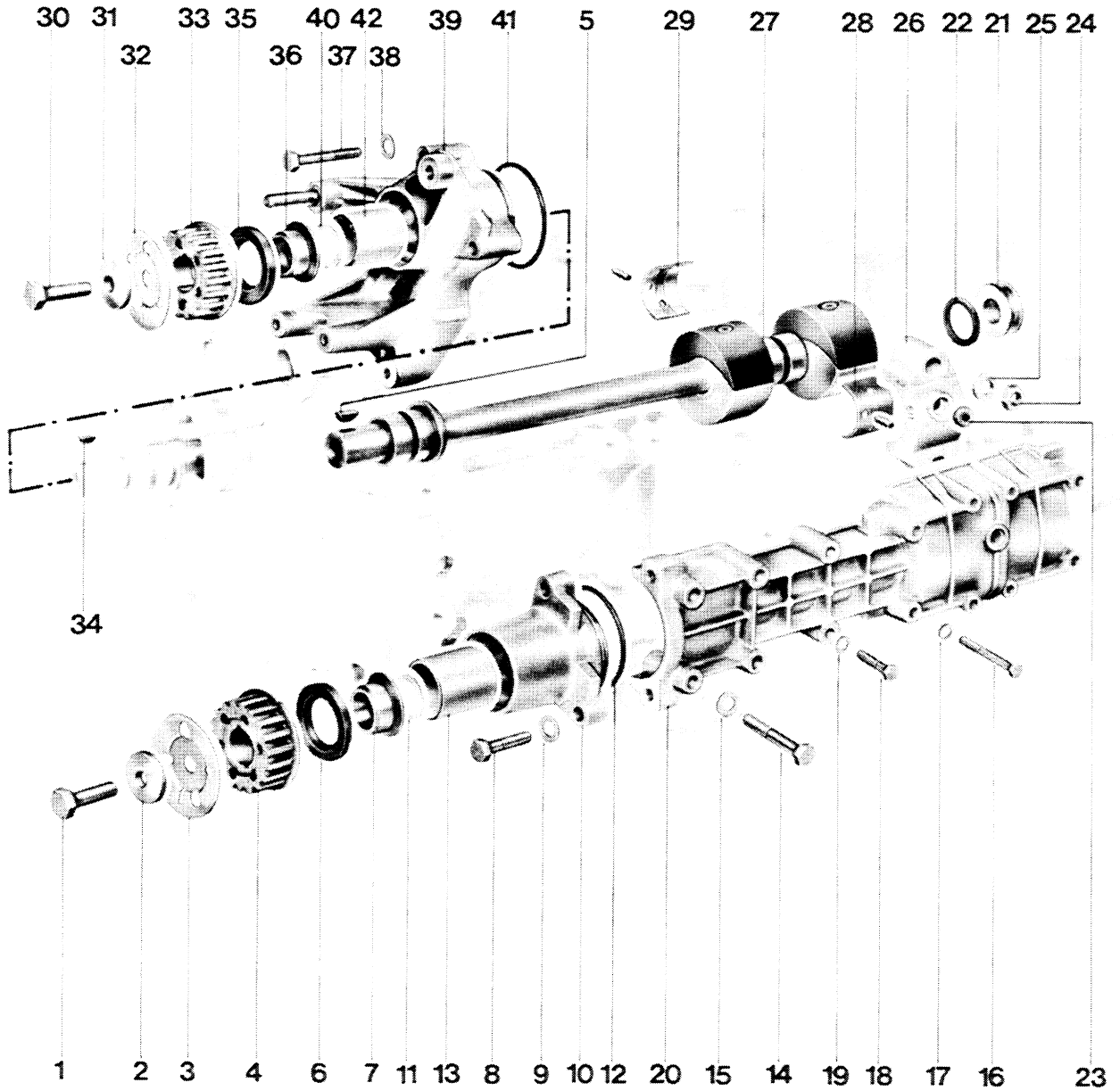

No.	Description	Qty.	Note When:		Special Instructions
			Removing	Installing	
1	Bolt M 10 x 35	1		Coat threads with Loctite 574, torque: 45 Nm, hold with Special Tool 9200.	
2	Washer	1		Position correctly	
3	Collar for upper compensating shaft	1		Position correctly, locating tab protrudes into unmarked groove of drive gear. Mark "0" can be seen in large opening of collar.	
4	Drive gear for compensating shaft	1		Check movement on seat of compensating shaft, machining if necessary. Give seat a light coat of Optimoly HT.	see page 13 - 50
5	Woodruff key	1			
6	Shaft seal 30 x 47	1		Replace, lubricate sealing lip with oil, mark (arrow) faces in turning direction of camshaft. Identical part as shaft seal of camshaft.	see page 15 - 24
7	Spacer	1			
8	Bolt M 8 x 35	3			

No.	Description	Qty.	Note When:		Special Instructions
			Removing	Installing	
23	Seal	1		Replace, install in bearing bridge take-up bore with grease.	
24	Nut M 8	2		Torque: 30 + 3 Nm	
25	Washer	2			
26	Bearing bridge for compensating shaft	1			
27	Upper compensating shaft	1			
28	Bearing shell	1		Check for correct fit	
29	Bearing shell	1			
30	Bolt M 10 x 35	1		Coat threads with Loctite 574, torque: 45 Nm, hold with Special Tool 9200.	
31	Washer	1		Position correctly.	
32	Collar for lower compensating shaft	1		Position correctly, locating tab protrudes into groove "0" of drive gear; mark "0" can be seen in square opening of collar.	
33	Drive gear for compensating shaft	1		Check movement on seat of compensating shaft, machining if necessary. Give seat a thin coat of Optimoly HT.	

No.	Description	Qty.	Note When:		Special Instructions
			Removing	Installing	
34	Woodruff key	1			
35	Shaft seal 30 x 48	1		Replace, lubricate sealing lip with oil.	
36	Spacer	1			
37	Bolt	3			
38	Washer	3			
39	Lower bearing housing	1			
40	Polyester seal	1		Replace, check for correct seating.	
41	O-ring	1		Replace, lubricate lightly with oil; position correctly.	
42	Sleeve	1			see page 13 - 42

No.	Description	Qty.	Note When:		Special Instructions
			Removing	Installing	
9	Washer A 8.4	3			
10	Upper bearing housing	1			
11	Polyester seal	1		Replace, check for correct fit.	
12	O-ring	1		Replace, give light coat of oil, do not position incorrectly.	
13	Sleeve	1			see page 13 - 42
14	Bolt M 8 x 55	4			
15	Washer A 8.4	4			
16	Bolt M 6 x 50	8			
17	Washer A 6.4	4			
18	Bolt M 6 x 42	2			
19	Washer A 6.4	2			
20	Upper compensating shaft housing	1	If necessary, heat housing cover with a hot air blower to loosen the sealing compound. Use Loctite adhesive remover 60646.	Apply coat of Loctite 574 (was 638) with a velours roller on sealing surface. Check tightening procedures.	see page 13 - 43
21	End ring	1			
22	Round seal	1		Replace	

INSTALLING BEARING BRIDGES OF COMPENSATING SHAFTS 1985/2 MODELS

Crankcase upper and lower sections as well as bearing bridges of compensating shafts are machined together and must always be installed together. Check codes.

Installing Bearing Bridges of Compensating Shafts

In installed state it will be possible to read the codes of both bearing bridges from the front (as seen looking forward in car).

In addition, the bearing bridges are stamped with 1 and 2.

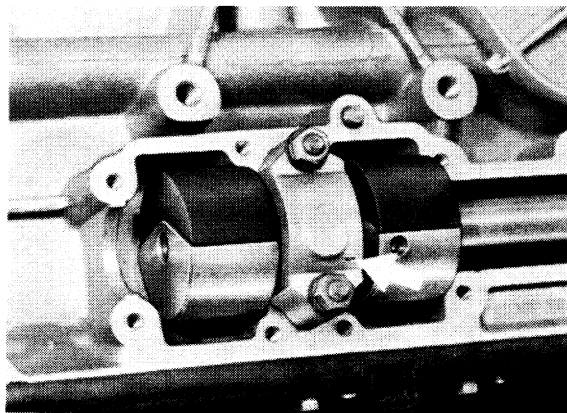

1 = Right side

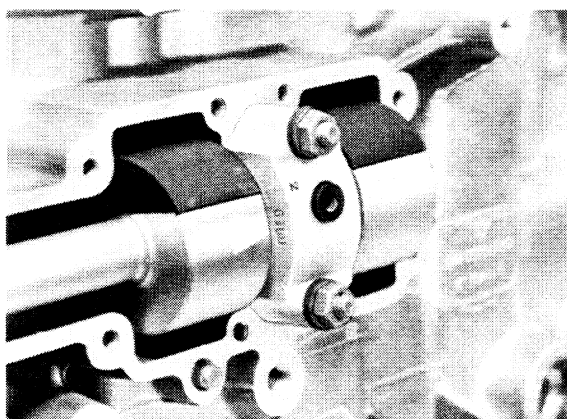

Picture shows the left compensating shaft.

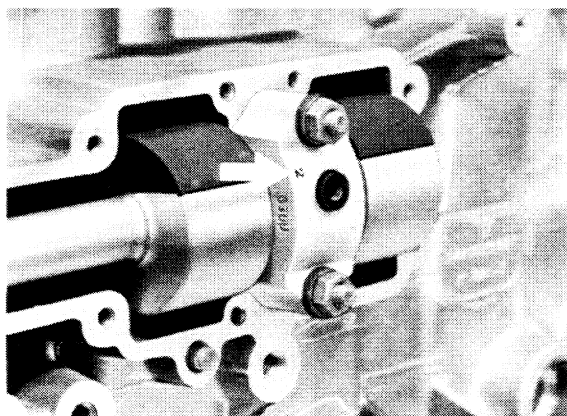

2 = Left side

Note

The bearing bridge for the left balance shaft has an oil feed bore for the exhaust turbo-charger. Before installing the balance shaft, it is vital to ascertain that the seal ring is in position in the take-up bore of the bearing bridge (use grease).

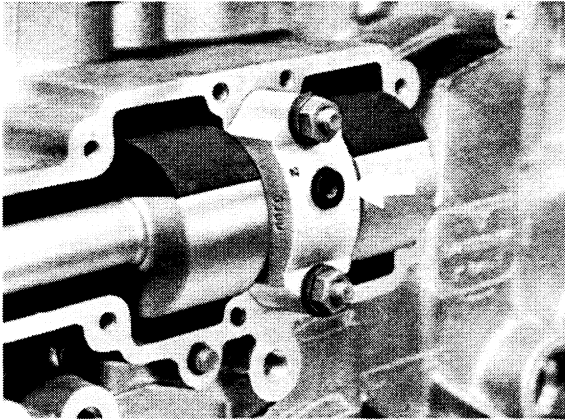
**Assembly note**

Whenever performing repairs on the engine, make sure the seal is replaced.

NOTES ON ASSEMBLY

'85 MODELS ONWARD

ENGINE TYPE M 44.05/06/07/08

TORQUING PROCEDURE, CRANKCASE UPPER HALF - COMPENSATING-SHAFT COVER

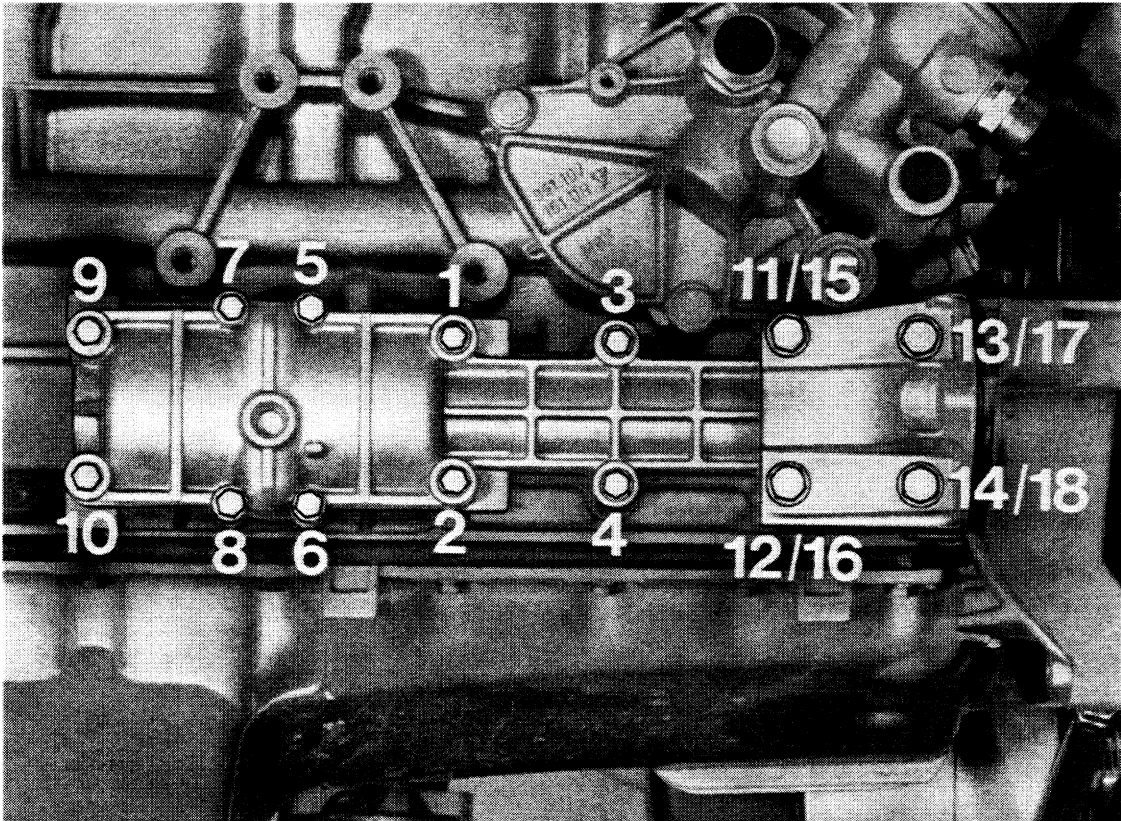
Note:

When aligning crankcase upper half and compensating-shaft cover, proceed as follows:

1. Tighten all hex bolts by hand
2. Install bearing housing with O-ring lightly oiled but without mounting bolts.
3. Tightening torque for M6 bolts: 10 Nm (7 ftlb)
Tightening torque for M8 bolts in 2 stages.
1st stage 15 Nm (11 ftlb)
2nd stage 20 Nm (14 ftlb)

Torquing sequence: see illustration.

NOTES ON ASSEMBLY

'87 MODELS ONWARD

ENGINE TYPE M 44.40/05/06/07/08

TORQUING PROCEDURE, UPPER CRANKCASE HALF/COMPENSATING SHAFT COVER BOLTS (with integrated bearing bridge)

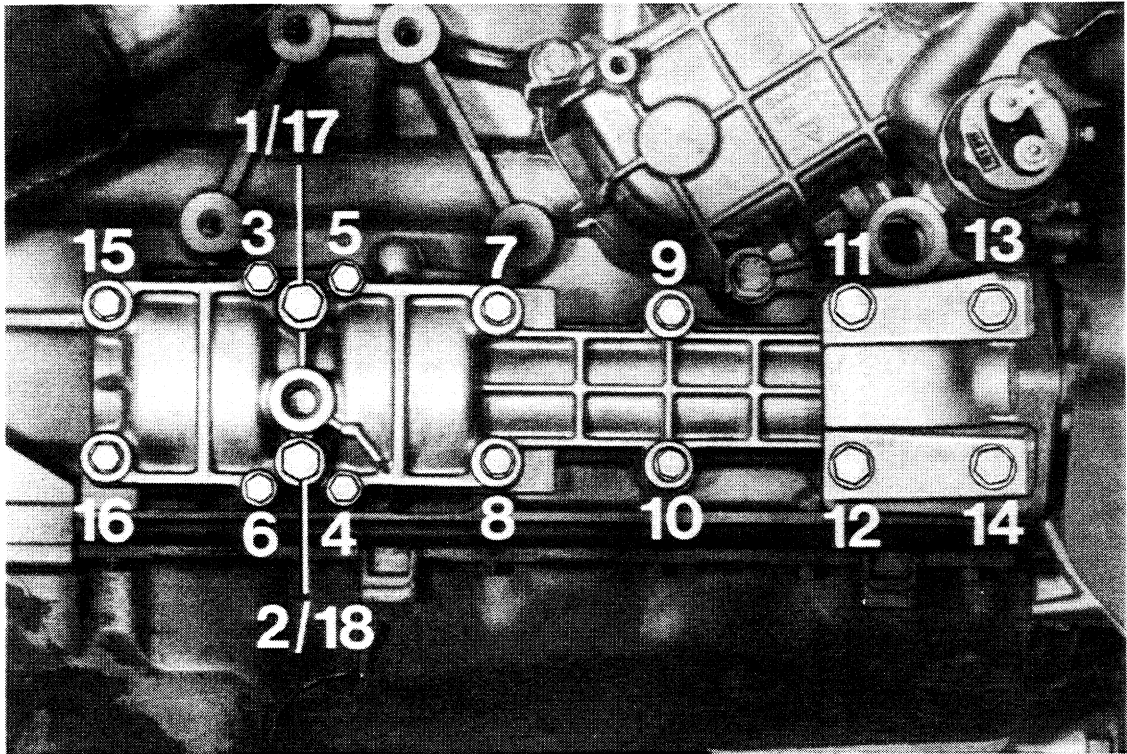
Note:

It is imperative to align upper half of crankcase and compensating-shaft cover as follows:

1. Tighten all hex bolts by hand.
2. Place bearing housing in position with O-ring lightly oiled, but without mounting bolts.

Torquing sequence: see illustration

1st stage No. 1 + 2	Tightening torque for M8 bolts	15 Nm (11 ftlb)
2nd stage No. 3...16	Tightening torque for M6 bolts	10 Nm (7 ftlb)
	M8 bolts	20 Nm (14 ftlb)
3rd stage No. 17 + 18	Tightening torque for M8 bolts	33 Nm (24 ftlb)

No.	Description	Qty.	Note When:		Special Instructions
			Removing	Installing	
1	Nut M 10	1			
2	Washer A 10.5	1			
3	Roller or roller with slot	1		Check	
4	Nut	1			
5	Washer A 10.5	1			
6	Tensioning roller for compensating shaft belt	1		Check	
7	Compensating shaft belt	1	Handle with care, do not twist or turn; store separately	When installing belt make sure side of belt with color coded tooth faces out	
8	Bolt M 10 x 35	1	Hold with Special Tool 9200 when unscrewing	Same as for removal	
9	Washer	1		Position correctly	
10	Collar	1		Position correctly	
11	Bolt M 10 x 35	1			

No.	Description	Qty.	Note when:	
			Removing	Installing
12	Washer	1		Position correctly
13	Collar	1		Position correctly
14	Balance shaft drive gear	1		Check movement on seat of balance shaft
15	Woodruff key	1		
16	Balance shaft drive gear	1		Check movement on seat of balance shaft
17	Woodruff key	1		Torque: 8 Nm
18	Bolt M6x16 - 8.8	4		
	Hexagon socket screw M6x2.5 - 10.9	4		Torque: 13 Nm
	Use from Mod. 87			
19	Washer A 6.4	4		
20	Pulley	1		
21	Bolt M16x1.5x60	1		Torque: 210 Nm
22	Washer			Position correctly, pay attention to surve, see Page 13-49
23	Gear for balance shaft drive	1		

No.	Description	Qty.	Note when:	
			Removing	Installing
24	Gear for camshaft drive	1		Belt collar faces compensating shaft drive gear
25	Woodruff key	1		
26	Thrust washer	1		
27	Seal	1		Replace

ASSEMBLY NOTES ON SECURING THE PULLEY

The pulley (A) without recess must only be installed for old crankshafts without extended journal for accommodation of the servo pump drive. Pulley (B) with recess for crankshaft with extended journal can also be used on old crankshafts.

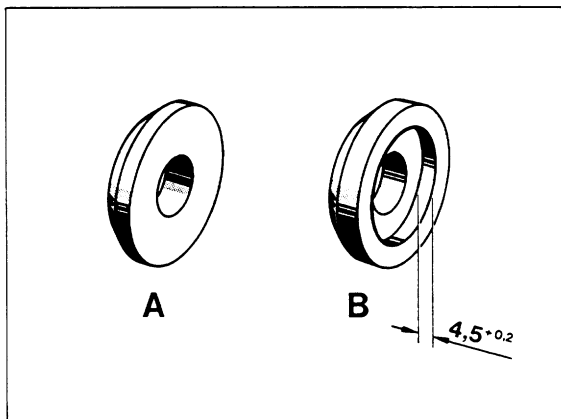

INSTALLING DRIVE GEARS OF BALANCE SHAFTS (Since 1984 Models)

Note:

Groove code "U" is omitted on drive gears.

Installing Drive Gear of Upper Balance Shaft

1. Woodruff key groove of balance shaft faces up.
Insert woodruff key.
Apply thin coat of Optimoly HT on bearing surface for drive gear.

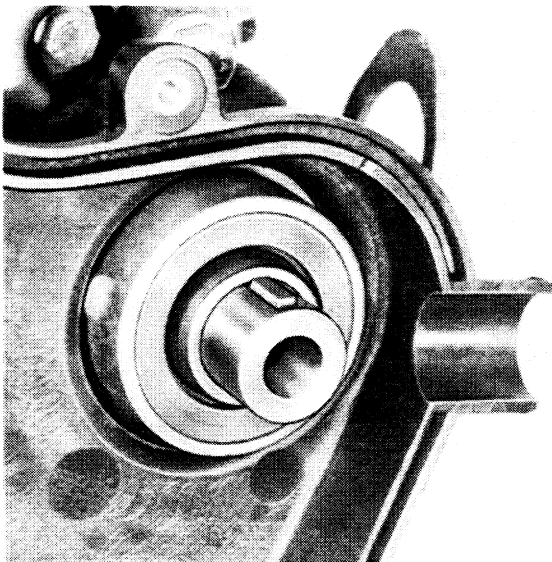

2. Push drive gear with groove code "O" on woodruff key.

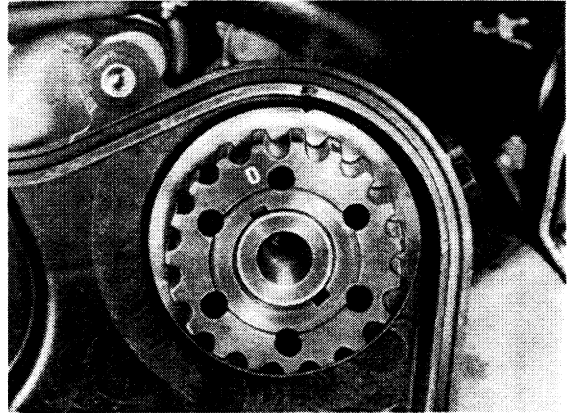

3. Install collar that its locating tab protrudes into unmarked groove of drive gear.
Code "O" can be seen in large bore of collar. Install bolt and washer.
Coat threads of bolt with Loctite 574.

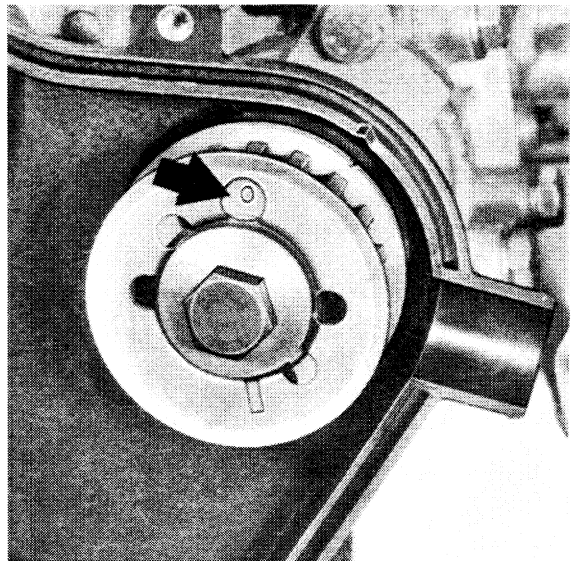

4. Tighten bolt while holding with Special Tool 9200.

Tightening torque: 45 Nm.

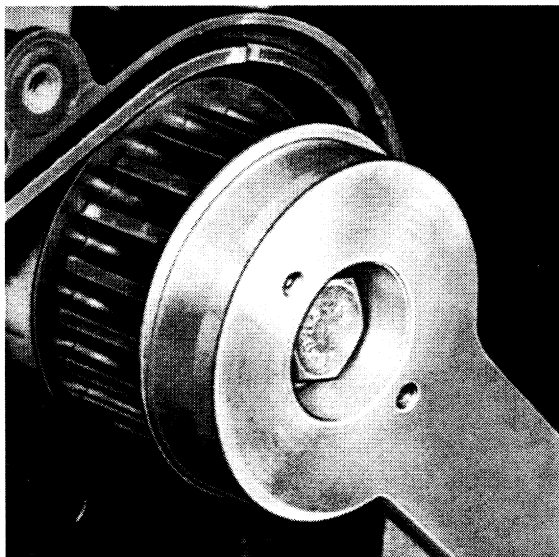

Installing Drive Gear of Lower Balance Shaft

1. Woodruff key groove of balance shaft faces up. Insert woodruff key.

Give bearing surface for drive gear a thin coat of Optimoly HT.

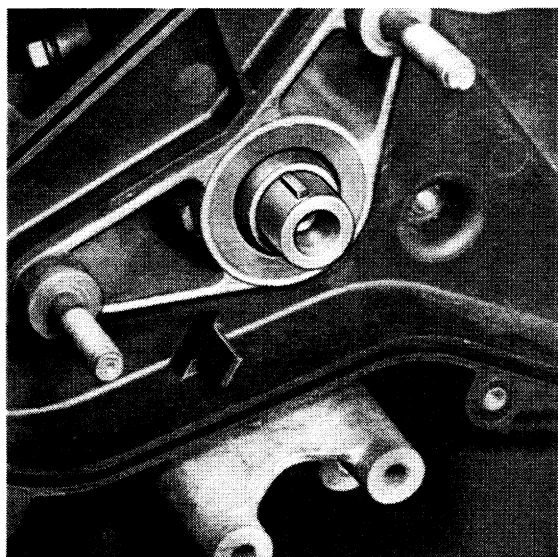

2. Push drive gear without a groove code on woodruff key.

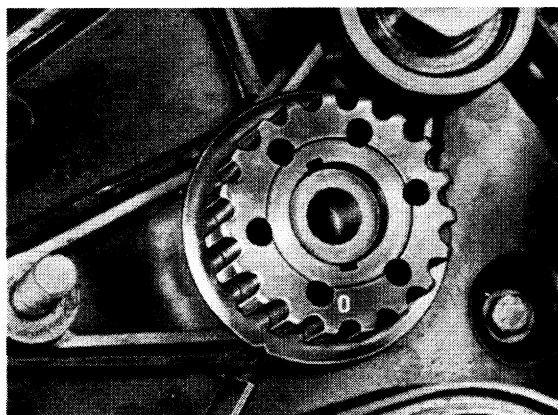

3. Install collar that its locating tab protrudes into groove "O" of drive gear.

Code "O" can be seen in square opening of collar.

Install bolt and washer.

Coat threads of bolt with Loctite 574.

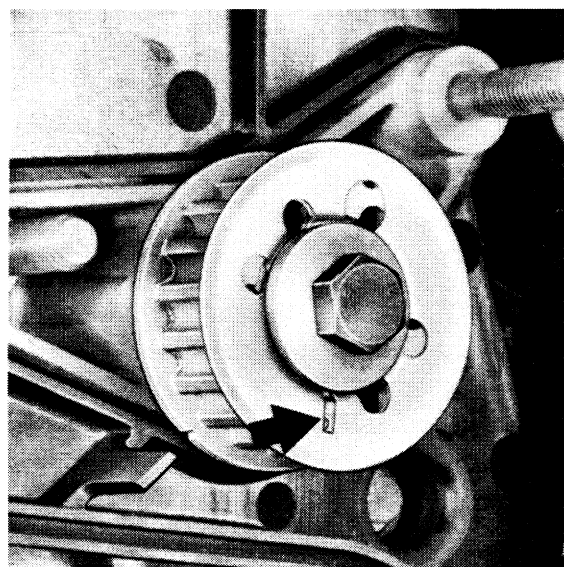

4. Tighten bolt while holding with Special Tool 9200.

Tightening torque: 45 Nm.

MACHINING CYLINDER BORES IN UPPER CRANKCASE SECTION

The upper crankcase section is an aluminum alloy product and contains minute particles of pure silicium.

In order to have an usable cylinder surface finish, the cylinder bores have to be machined in a manner that the silicium particles protrude out of the aluminum and therefore pistons and piston rings only have contact with the silicium.

If it is necessary to machine cylinder bores, they can be restored with a SUNNEN CK - 10 / CV - 616 cylinder repairing machine for installation of oversize pistons.

Standard size	100.00 mm
Oversize 1	100.50 mm
Oversize 2	101.00 mm

Single cylinder bores can be machined as required, since pertinent oversize pistons weigh the same as standard pistons.

Prior to machining cylinder bores it is recommended to check the stocks on hand for pertinent tolerance groups and, if necessary, to hone the bore for a certain piston size which is available. There could be problems in supplying pistons of certain tolerance groups depending on circumstances.

The following procedures are necessary.

Rough turning to 0.1 mm before finished size.

Dressing to 0.02 mm before finished size.

Polishing to finished size.

Lapping with Sunnen silicium mixture.

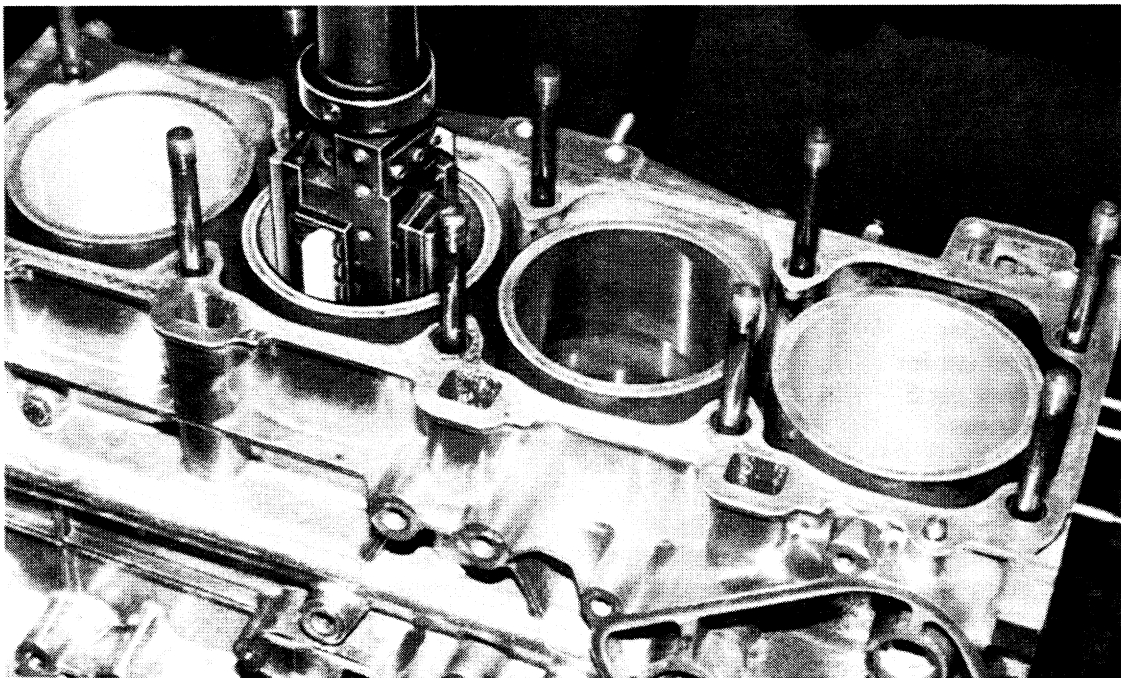

PROCEDURES

It is absolutely necessary to bolt the upper and lower crankcase sections together with help of the bearing studs prior to machining.

Tightening Procedures	Torque in Nm	Threads
3 steps: step 1	20	M 12 x 1.5
step 2	40	
step 3	75	
2 steps: step 1	20	M 10
step 2	50	M 6
	10	M 8
	20	

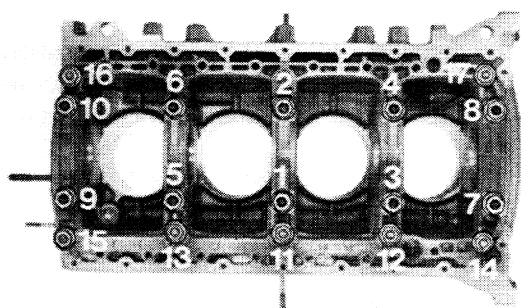

TOOLS

Machine	CK-10 with filter CV-616 with filter
Grinding attachment	CK-3000 or CK-2600
Grinding oil	MB-30 or MAN-845
Felt inserts	C30-F 85 1 set
Silicium mixture	AN-30
Storage box for felt inserts	AN-35
Stone holder set for felt inserts instead of honing stones	CK-3035 A 1 set
Stone holder set for honing stones for 3 different stones (types)	CK-3035 A 3 set
Felt holder seat instead of guide shoe	CK-3130 A 1 set
Roughing stone set	C30-J 55 ++ shorten to 70 mm length
Dressing stone set	C30-J 84 ++ shorten to 70 mm length
Polishing stone set	C30-C 03 - 81

Honing Procedures

Perform all honing and lapping jobs without the upper dressing guide shoe.

The protrusion of the bronze bar on main guide shoe no. 3 has to be eliminated; flush with guide shoe base.

Setting Up Machine

Roughing adjustment table described in column 1.

Dressing adjustment table described in column 2.

Polishing adjustment table described in column 3.

Lapping – uncovering the silicium crystals.

1. Set up machine as described in column 4 of test sheet.
2. Thoroughly remove all abrasive residue from previous honing jobs with filtered honing oil.
3. Wipe cylinder bores dry and apply a thin coat of thoroughly mixed silicium mixture.

Note:

If the silicium mixture is too consistent, it can be diluted by adding fresh honing oil and mixing thoroughly.

4. Holders with felt inserts are now placed in the grinding attachment instead of guide shoe and honing stones.

Adjusting to the cylinder diameter is made with a gage as for the guide rails and honing stones.

5. Soak felt inserts in filtered honing oil and coat with silicium mixture.
6. Stop grinding oil feed; cylinders are lapped without grinding oil!

Machining Cylinders

Guide grinding attachment into bore. Turn feed wheel anticlockwise until felt inserts rest on walls. Start machine and keep turning handwheel anticlockwise until needle of load instrument reaches approx. 20 to 30 %.

Now set scale of feed wheel to 20.

The machine stops on its own after about 80 seconds. The cylinder surface will now be dull and without gloss.

First coat felt inserts with new silicium mixture before going on to the next cylinder.

Note:

If holder with felt inserts are not being used, they must be kept in the storage box to avoid contact with dirt.

Never reuse old silicium mixture.

Machining Cylinder Bores with SUNNEN 10/CV 616
Machine

	1.Roughing to Dia.	2.Dressing to Dia.	3.Polishing to Dia.	4.Lapping
Cylinder dia. Standard: 100.00 mm				
Cylinder dia. Oversize 1 : 100.50 mm	100.40 mm	100.48 mm	100.50 mm	100.50 mm
Cylinder dia. Oversize 2 : 101.00 mm				
Cylinder length 145 mm				
Honing head type	CK-3000 or CK-2600	ditto	ditto	ditto
Travel scale for stone length	70 mm	70 mm	70 mm	70 mm
Adjustment on scale	160 mm	160 mm	160 mm	125 mm
Speed (rpm)	125 CK/CV	125 CK/CV	125 CK/CV	185 CK/ 230 CV
Strokes per minute	49 CK/57 CV	49 CK/57CV	49 CK/57 CV	73 CK/80CV
Feed	5	4	3	2
Stone protrusion top	21 mm	21 mm	21 mm	2 mm
Roughing stone	C 30 - J 55			
Dressing stone		C 30 - J 84		
Polishing stone			C 30-C03-81	
Felt insert				C 30-F 85
Display (%)	30 - 40	30 - 40	20 - 30	20 - 30
Material removed	0.07 mm/	0.03 mm/	0.01 mm/	approx. 20 lines
Adjustment on feed wheel	10 lines	10 lines	10 lines	80 seconds running time
Surface finish (Rt.)	approx. 7 - 8 my	approx.2my	approx 0.6- 0.8 my	approx. 1 - 2 my

A chamfer of 0.5 mm x 30° has to be machined on the upper cylinder wall of machined cylinder bores after finishing the honing procedures.

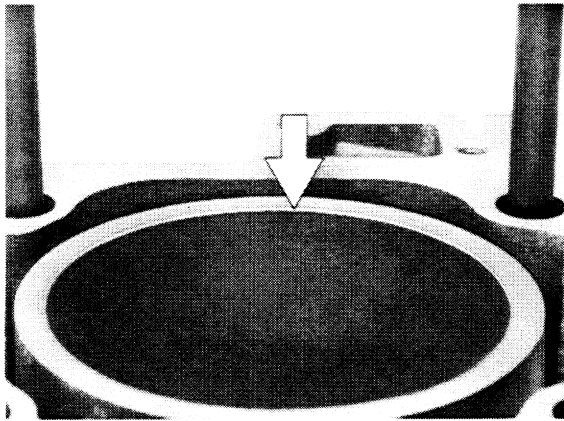
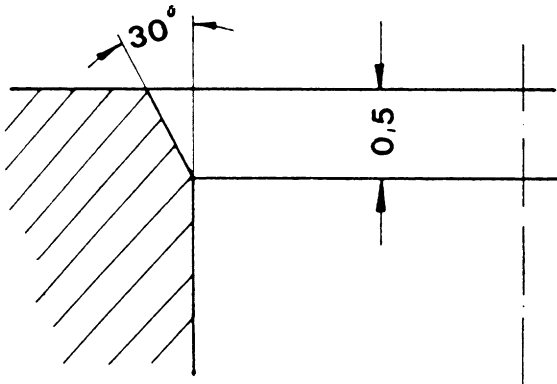

Clean upper and lower crankcase sections thoroughly to remove abrasion residue and silicium paste prior to assembling.

TOOLS

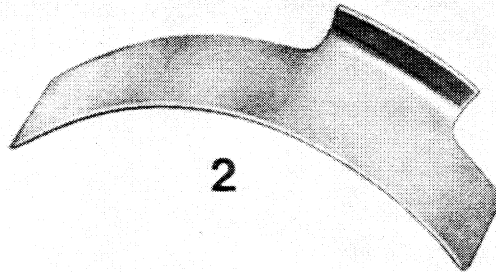
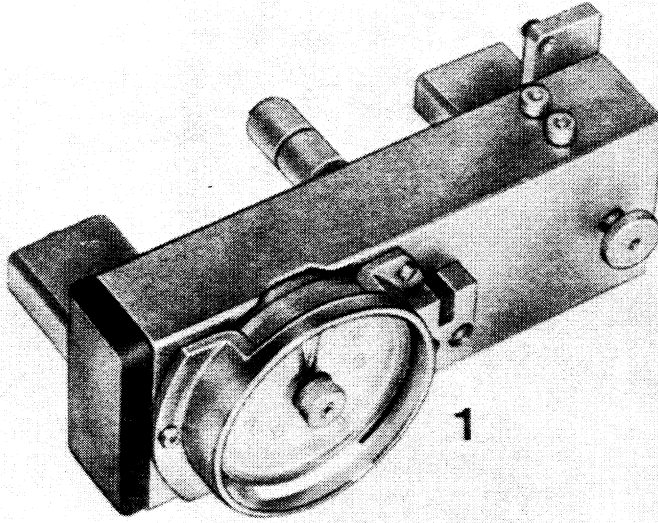

No.	Description	Special Tool	Remarks
1	Belt tightness tester	9201	
2	Adjusting gauge for roller with slot	9207	

CHECKING AND ADJUSTING TIGHTNESS OF CAMSHAFT DRIVE BELT

Note

The tightness of the drive belt must only be checked and adjusted on a cold engine (room temperature).

Checking

1. Turn crankshaft clockwise slowly until TDC mark on camshaft sprocket is aligned with cast mark in console for the distributor cap.

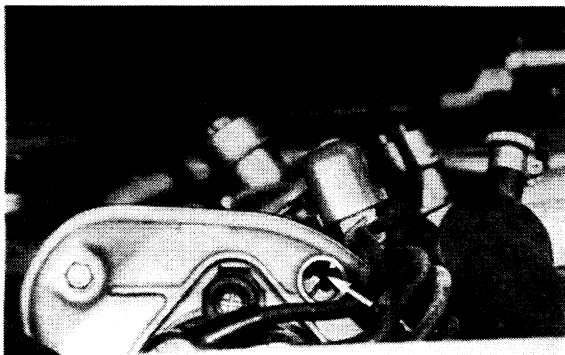

Note

Check drive belt for wear and damage at same time while turning.

2. TDC mark on flywheel and cast boss on clutch housing must also be aligned.

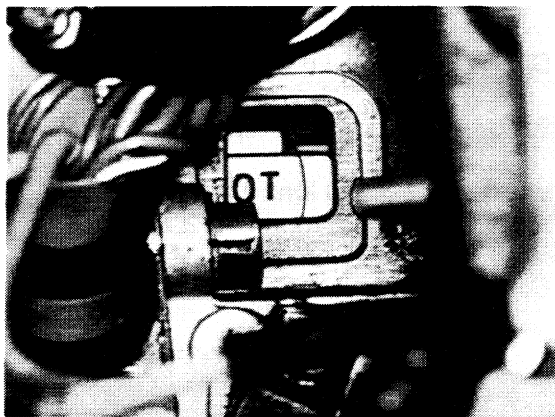

3. Turn engine on crankshaft anticlockwise approx. 10° on crankshaft, which is equal to about 1.5 teeth toward mark on the camshaft sprocket.
4. Prepare Special Tool 9201 for checking. Pull out lockpin on special tool and push out test pin opposite the lockpin completely. Align drag needle with gage needle.
5. Slide special tool on to drive belt. Press in test point (arrow) slowly until lockpin is felt to engage and read displayed value from the dial gage.

Note

Always line up the drag needle and gage needle after engagement of the lockpin to exclude incorrect display (by turning anticlockwise).

Adjusting Value:

Scale Value:

New belt: 4.0 ± 0.3
 Used belt: 2.7 ± 0.3

Control Value:

for operation

up to about 3,000 km 2.4 to 4.3
 more than 3,000 km 2.7 ± 0.3

Correct drive belt tightness if necessary.

6. Turn the tensioning roller anticlockwise while tightening.
 Turn the tensioning roller clockwise while loosening.

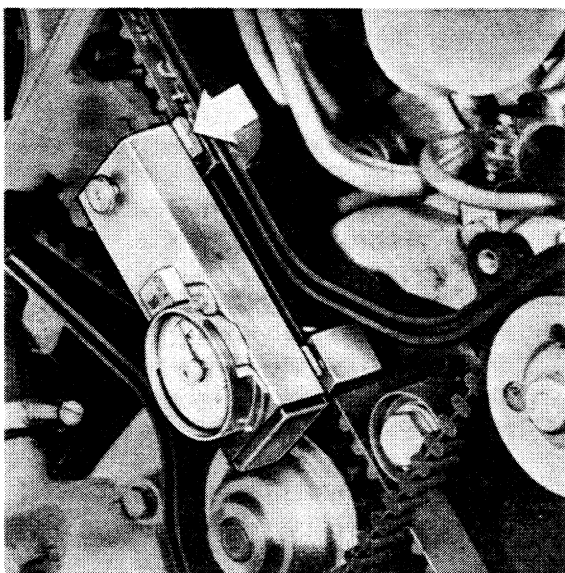
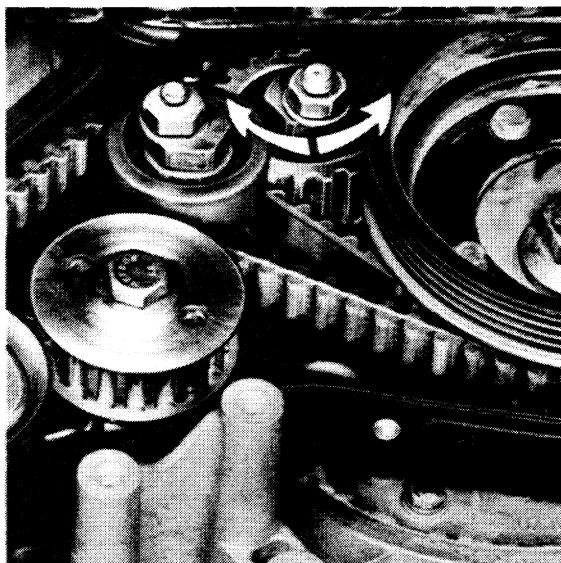

7. Tighten mounting nuts with specified torque while counterholding.
8. Turn engine clockwise two complete turns and align TDC mark on camshaft sprocket with cast mark in console for distributor cap. Turn engine anticlockwise approx. 10 crankshaft degrees from this position.
9. Recheck tightness of drive belt and, if necessary, correct.

Note

Sliding shoes must have complete contact on surface of drive belt.
 The special tool must not be turned nor moved on the belt while checking.

INSTALLING CAMSHAFT DRIVE BELT AND ADJUSTING TIMING

1. Turn engine crankshaft to TDC for cylinder no.

1. TDC marks on flywheel and cast clutch housing must be aligned.

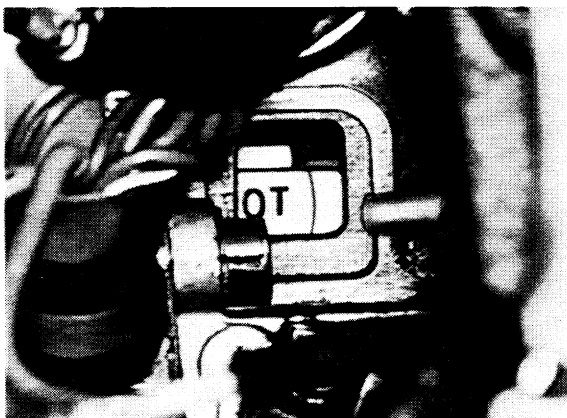

2. Align mark on camshaft sprocket with mark on rear drive belt cover.

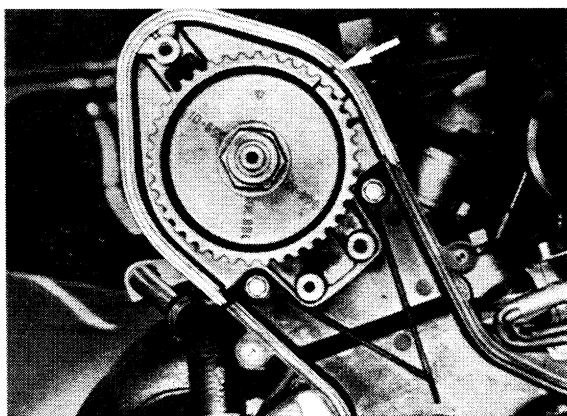

3. Install drive belt according to following procedures:

- Place belt on sprocket of crankshaft (1), tensioning roller (2), water pump pulley (3) and camshaft sprocket (4), preloading belt slightly by hand each time so that belt can be pushed on to camshaft sprocket.

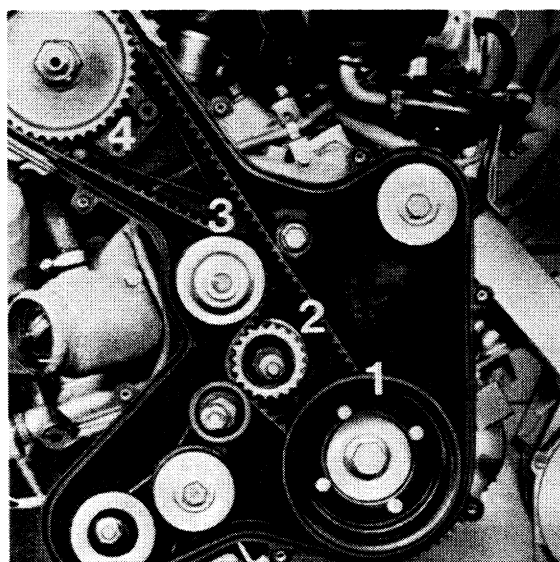

4. Tighten drive belt; see page 15 - 3.

REMOVING AND INSTALLING CYLINDER HEAD

Removing

The cylinder head can be taken off without removing the engine.

1. Disconnect battery ground wire.
2. Unscrew cap on coolant expansion tank.
3. Remove splash guard.
4. Unscrew coolant drain plug on radiator and drain coolant.

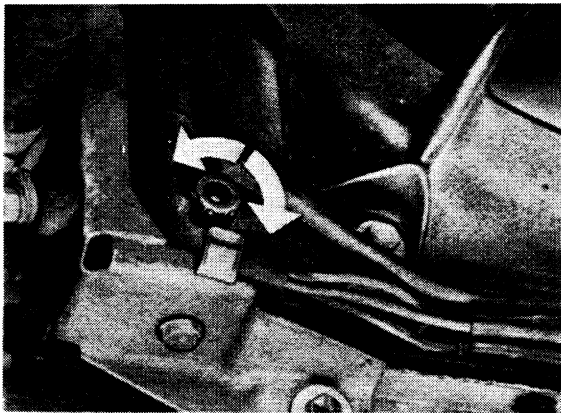
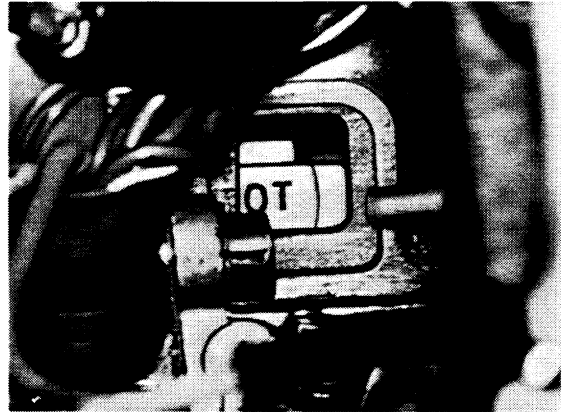

8. Remove distributor cap, unscrew distributor rotor and remove protective cap.

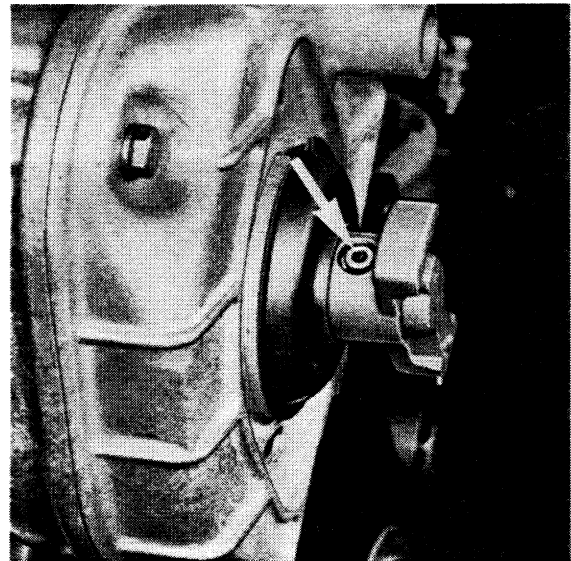

5. Remove poly-rib belt.
6. Remove drive belt cover.
7. Turn engine to TDC in cylinder no. 1.

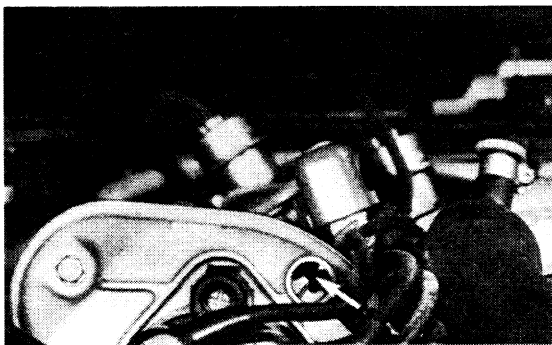

9. Remove mount for distributor cap.

10. Relax belt tension and pull camshaft belt off of camshaft sprocket.

11. Unscrew 2 mounting bolts on rear drive belt cover.

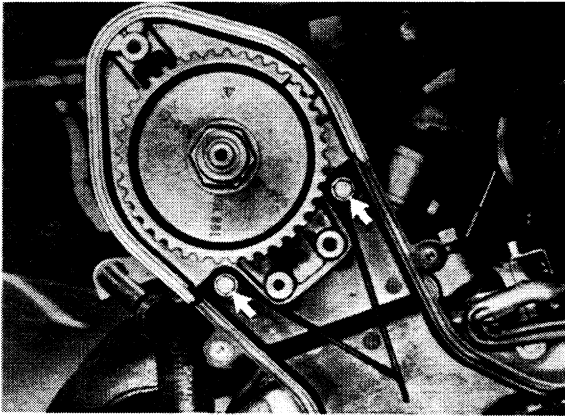

12. Unscrew fuel lines.

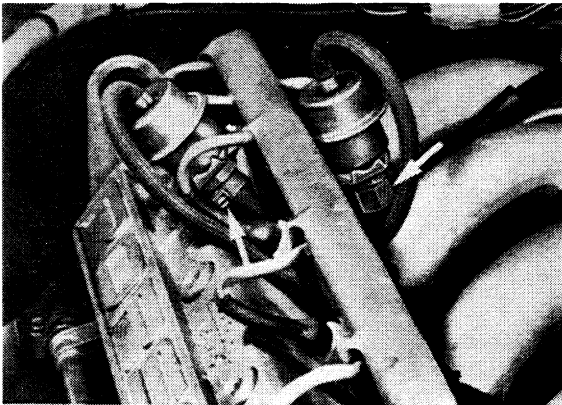

13. Remove plastic cover on fuel collection tube, pull off wire plugs on fuel injectors and lay wire harness aside.

14. Unscrew aluminum plugs, coolant line and bolts (with attached washers) and remove camshaft housing from cylinder head.

Note

Make sure that hydraulic valve tappets do not fall out and are not mixed up.

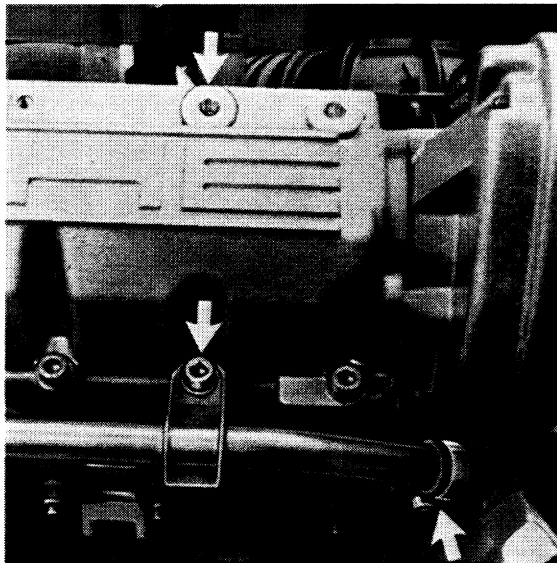

15. Remove air cleaner assembly.

16. Unscrew bolt of intake brace.

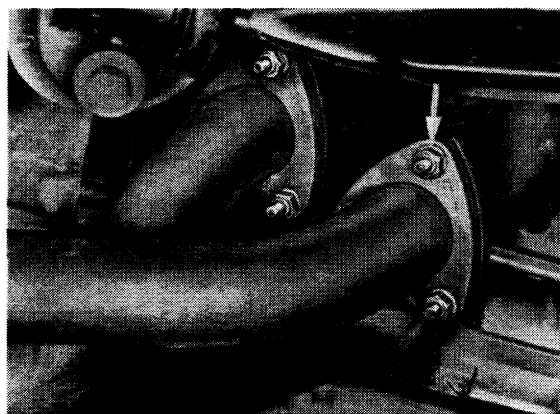
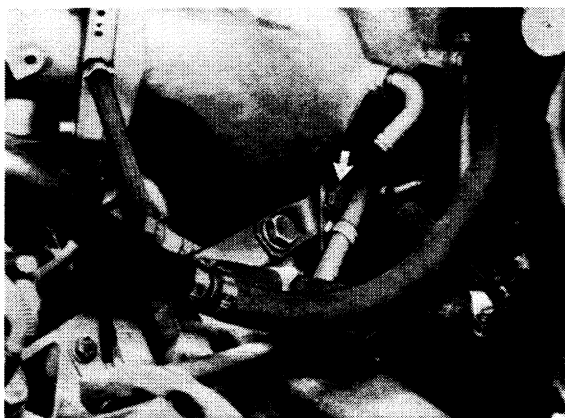

17. Remove intake distributor by dismantling holder on oil dipstick tube, hose on brake booster, hose on intake distributor, retaining clamp on accelerator cable and mounting bolts of intake distributor/cylinder head.

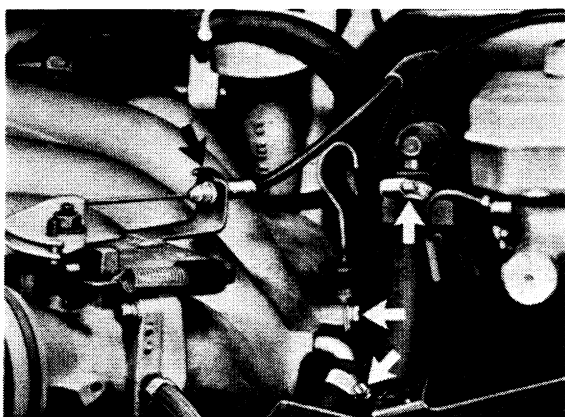

18. Unscrew bolts of exhaust manifold/catalytic converter pipe flange.

19. Unscrew hose clamp on heater regulating valve and two screws on neck for coolant circuit.

20. Unscrew mounting nuts for cylinder head.

Note

Order for unscrewing mounting nuts is crosswise from outside to inside.

21. Take off cylinder head.

Installing

1. Install cylinder head gasket in correct position.

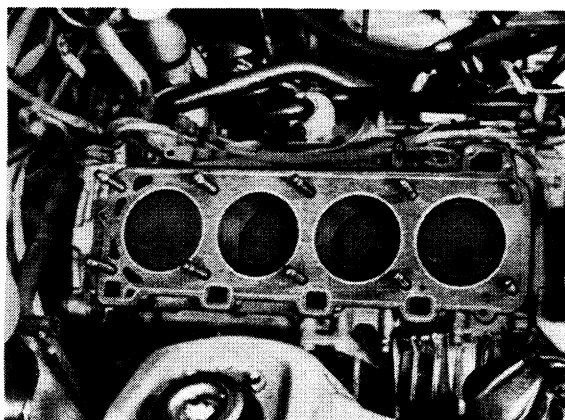

2. Mount cylinder head.

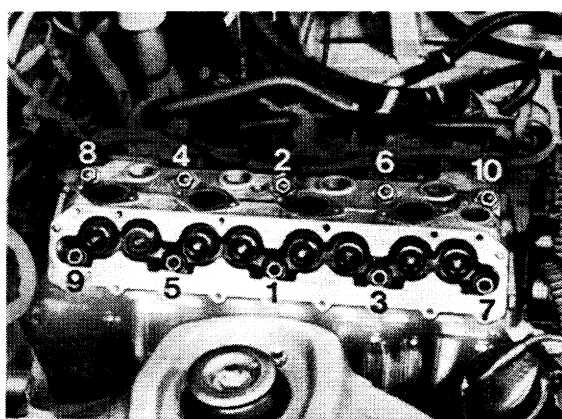

Tightening order: see figure.

Note

Never use a lubricant for installation of cylinder head nuts and washers. Only give the threads of studs a light coat of engine oil. The washers must not turn when tightening cylinder head nuts! If necessary, check this with paint stripes. In the repair sector the washers can be reused after roughening the bearing surface for the cylinder head with a rough sandpaper.

- A. Preloading Cylinder Head Gasket

1st step	20 Nm
2nd step	50 Nm
3rd step	90 Nm

3. Mount camshaft housing.
Tightening torque for socket head bolts: 20 Nm.
Tightening torque for aluminum plugs: 40 Nm.
4. Install drive belt, see page 15 - 5.
5. Adjust polyrib belt, see page 13 - 1.

Installation instructions

Tightening torque specifications for cylinder head

as from Model 82

Engine type M44. 01... 10

Applicable in conjunction with 12 mm high nut
and new washer

1st stage	20 Nm
2nd stage	90° torque angle
3rd stage	90° torque angle

A light film of oil must be applied to the stud
threads.

As from Model 89

Engine type M 44. 11/12 (2.7 l)

1st stage	20 Nm
2nd stage	60° rotation angle
3rd stage	60° rotation angle

A light film of oil must be applied to the stud
threads.

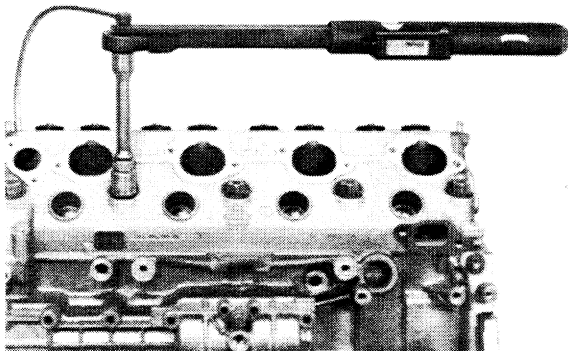

88/341

TOOLS

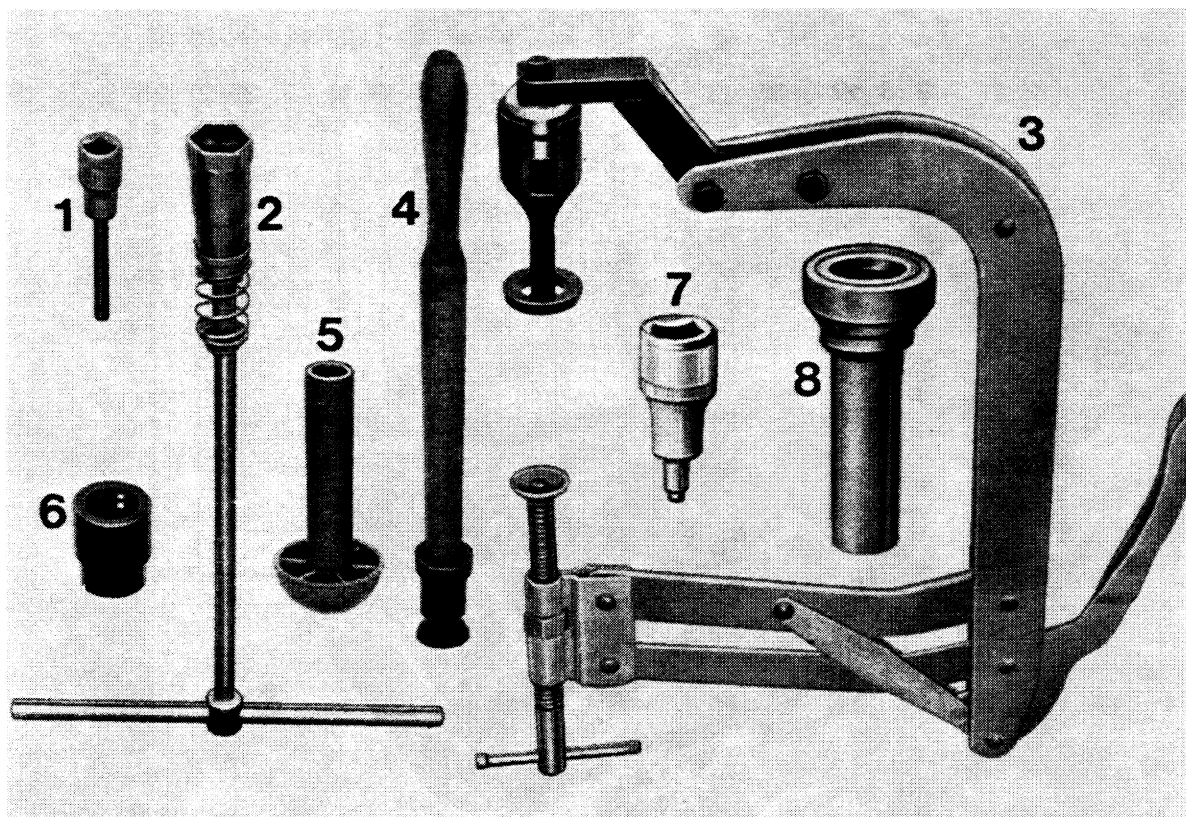

No.	Description	Special Tool	Remarks
1	Wrench socket	9133	
2	Spark plug wrench		Standard
3	Valve spring compressor	US 1020 with US 1020/1 or P 200 a	
4	Valve grinder		Standard
5	Pad for installation of valve stem seal	10 - 204	
6	Valve spring adjuster	9138/1	
7	Screwdriver socket	9205	
8	Pressure pad	9202	

DISASSEMBLING AND ASSEMBLING VALVE DRIVE

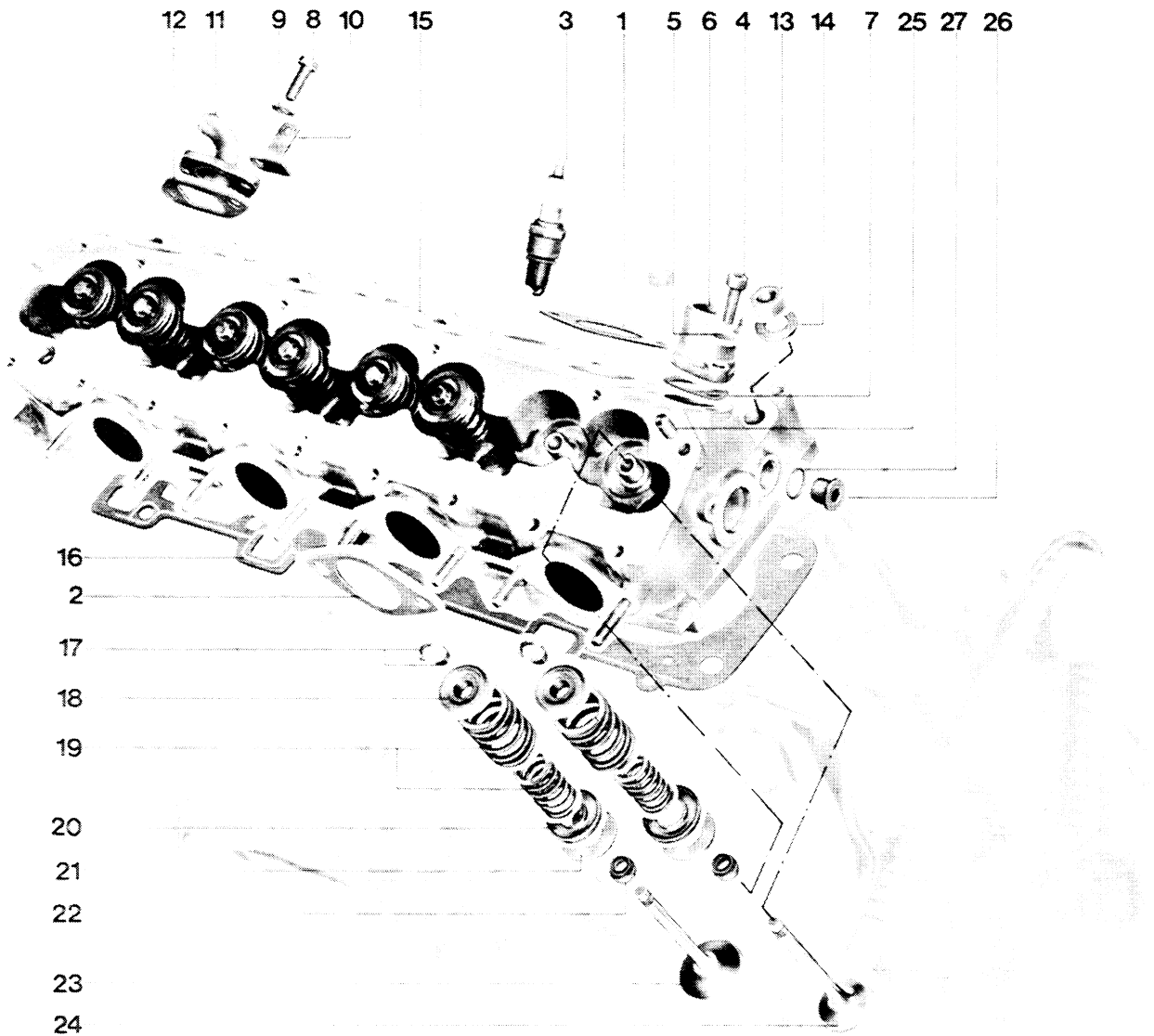

No.	Description	Qty.	Note When:		Special Instructions
			Removing	Installing	
1	Gasket	4		Replace	
2	Gasket	4		Replace	
3	Spark plug	4		Torque: 25 – 30 Nm (18 – 22 ft lb)	
4	Bolt 8 x 25	2			
5	Washer A 8.4	2			
6	Adapter	1			
7	Gasket	1		Replace	
8	Bolt 8 x 20	2			
9	Washer A 8.4	2			
10	Bracket	1			
11	Connector	1			
12	Gasket	1		Replace	
13	Nut	10		Give threads of studs a light coat of oil	

No.	Description	Qty.	Note When:		Special Instructions
			Removing	Installing	
14	Washer	10		Rounded surface faces up	
15	Cylinder head	1			
16	Cylinder head gasket	1		Always replace	
17	Valve keeper	16		Position correctly	
18	Spring retainer	8			
19	Valve spring set	8			
20	Valve spring disc	8			
21	Washer 0.5	x	Note quantity	If necessary, determine thickness and quantity; use Special Tool 9138/1	
	Washer 1.0	x			
22	Valve stem seal	8		Always replace	
23	Intake valve	4			
24	Exhaust valve	4			

No.	Description	Qty.	Note When:		Special Instructions
			Removing	Installing	
25	Dowel pin	2			
26	Plug	1			
27	Seal	1			

DISASSEMBLING AND ASSEMBLING VALVE TRAIN

Installing Cylinder Head

Note

The cylinder head can be removed from an engine in the car, see page 15 - 7.

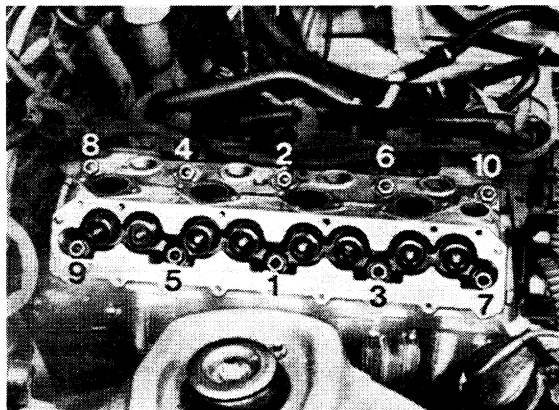

Tightening sequence (in 3 steps): see figure.

Loosening sequence: opposite.

Note tightening torque.

Note

Never use any lubricant for the installation of cylinder head nuts and washers. Only give threads of studs a light coat of engine oil.

Washers must not turn when tightening cylinder head nuts! Control by making paint marks if necessary.

During repairs, the washer can be made reuseable by roughening the bearing surface facing the cylinder head with coarse sandpaper.

Grinding Cylinder Head Mating Surface

Checking Cylinder Head for Distortion

Check mating surface of cylinder head for distortion with a feeler gauge blade and straight-edge.

Permissible distortion of mating surface:
0,05 mm. Cylinder heads with a distorted sealing surface can be resurfaced by grinding.
Permissible distortion after machining:
0,03 mm.

Grinding Cylinder Head

Only machine the sealing surface of a cylinder head enough to reach a level surface.
Wear limit: 23,6 mm

Sealing surface machining note:

Peak-to-valley 0.015 mm

If the new-dimension tolerance is exceeded during machining, a cylinder head gasket with a thickness of 1.4 mm must be fitted.

New distance A = 24 ± 0.1 mm

Wear limit distance A = 23.6 mm

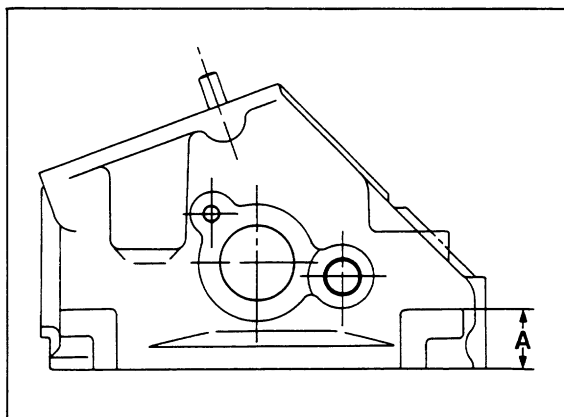

Note

When refacing the sealing surface on the combustion chamber side, always check the sealing surface on the camshaft side as well and reface if necessary.

Admissible distortion of the camshaft sealing surface:

When checking: 0.1 mm

after refacing : 0.03 mm

Before machining the sealing surface to the camshaft housing, check dimension "A" to avoid unnecessary work.

Before machining, plug the oil passage of the return valve. Remove cylindrical pins.

Cylinder head refacing dimension and Identification

New dimension : $24 \pm 0,1$ mm

Gasket : 1.1 mm

Identification : none

Refacing dimension : 23.8 to 23.6 mm

Gasket : 1.4 mm

Identification : N

Identification "N"

To be embossed on cylinders No. 1 and 4.

Punch character height "N" = 10 mm

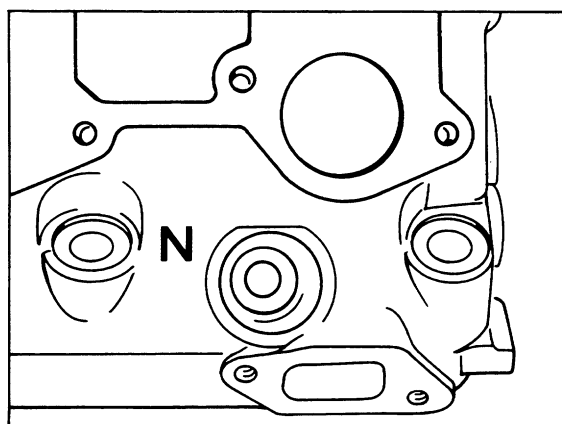

REPLACING VALVE GUIDES

TOOLS

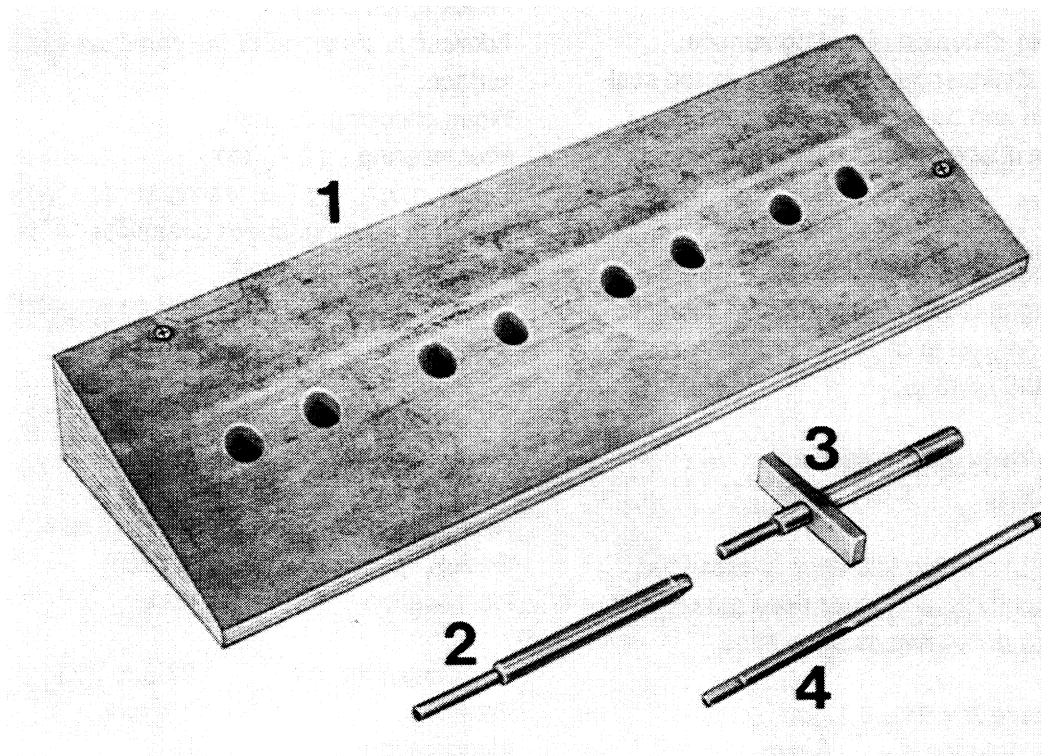

No.	Description	Special Tool	Remarks
1	Pressing out base	9220	
2	Driver	9224	
3	Pressure pad	9221	
4	Reamer	3015	

REPLACING VALVE GUIDES

1. Clean and inspect cylinder head. Cylinder heads, the valve seats or sealing surfaces of which can no longer be machined, are not suitable for replacement of valve guides.

2. Grind off enough of valve guides protruding from the camshaft end with a spot facer that guides are flush with the cylinder head.

Note:

Be careful not to damage guide collar for spring retainers.

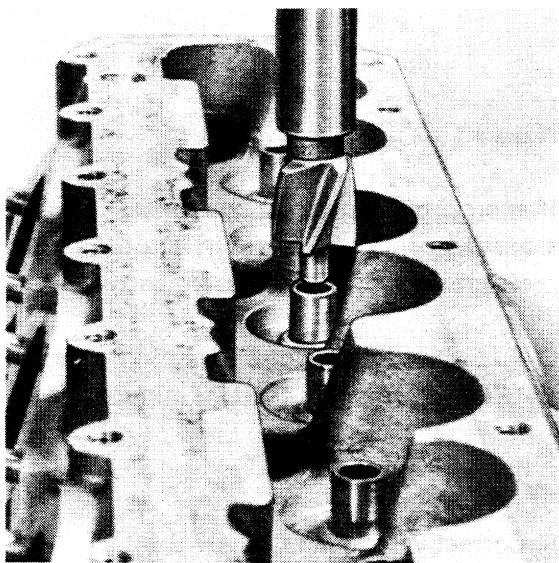

3. Place cylinder head on Special Tool 9220.

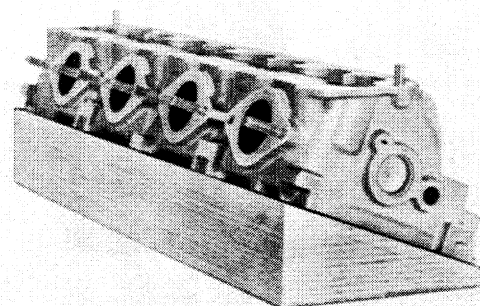

4. Loosen valve guides from the camshaft end with Special Tool 9224 by applying brief knocks and press out rest of guides toward combustion chamber end in a press.

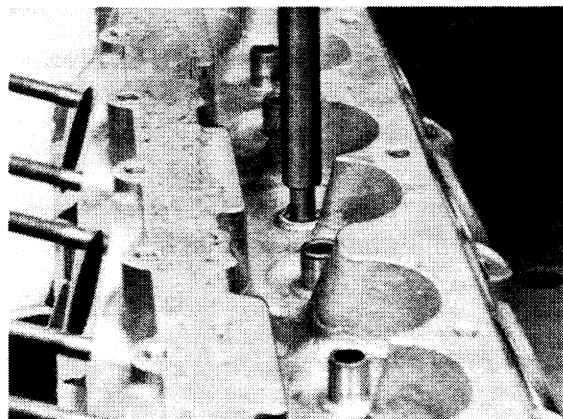

5. Measure bores in cylinder head with an internal gauge.

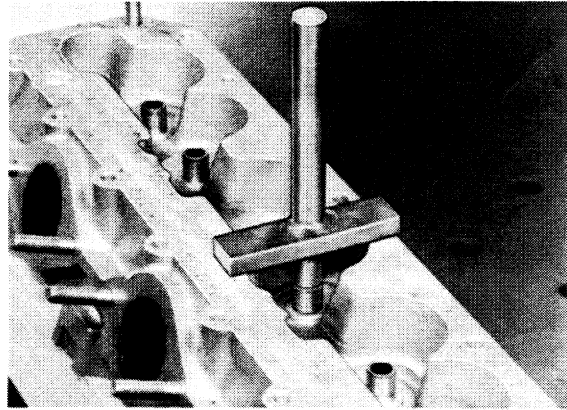
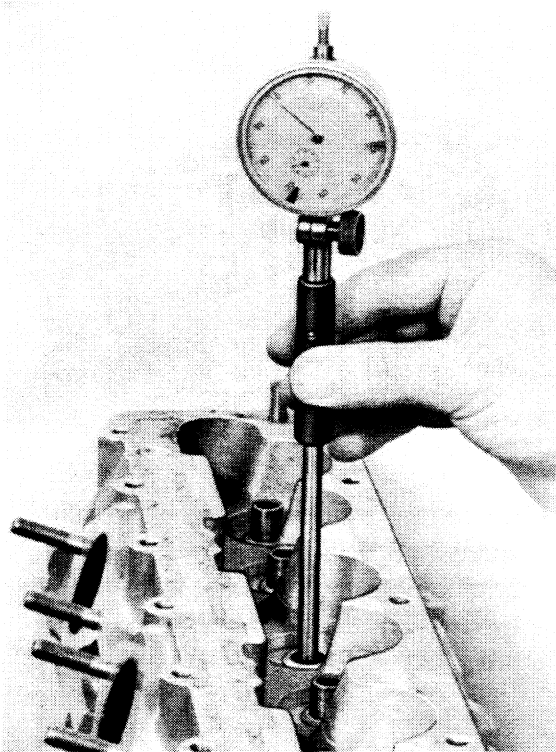

6. Grind off a service valve guide, Part No. 928 104 328 52 (13.27 mm outside diameter), accordingly.

The press fit for intake and exhaust valve guides must be 0.06 to 0.08 mm.

Example :

Cylinder head bore measures 13.01 mm.
Service valve guide ground off to outside diameter of 13.07 to 13.09 mm.

7. Coat valve guides with talcum powder, insert with a light knock, align and press into cylinder head against stop from the camshaft end with Special Tool 9221.

Note :

If appropriate workshop equipment is available, cool valve guides in liquid air and press into cylinder head heated to 190 °C.

Cylinder head must not be kept in heated state (190 °C) longer than 90 minutes.

8. Correct valve guides to size 9.00 to 9.015 mm (9 H 7) with a broach.

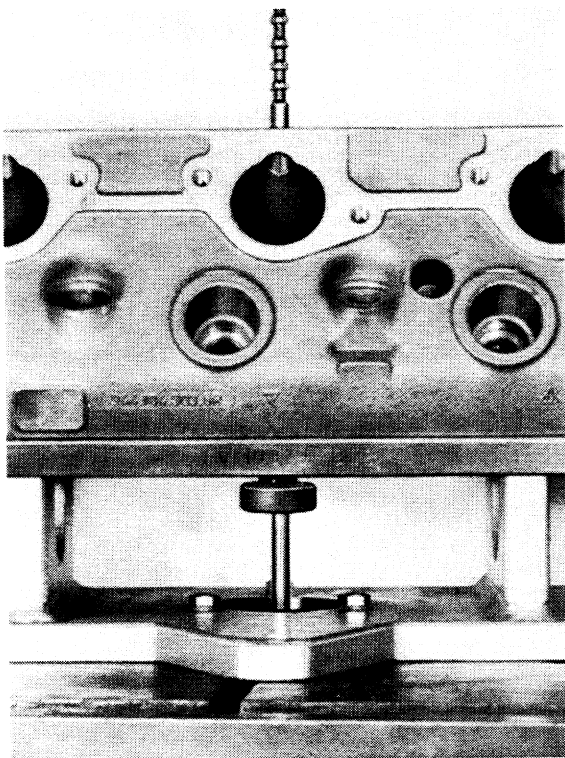

10. Valve seat inserts must also be machined after replacing valve guides. Grinding in valves with grinding paste would not be sufficient.

9. If necessary, valve guides could be reamed out with Special Tool 3015.

Procedures:

Always rub down valve guides with "petroleum" lube. Run out ream frequently to remove burrs. Check reamed out bore with Special Tool P 206 and, if necessary, ream out bore again with a dry ream.

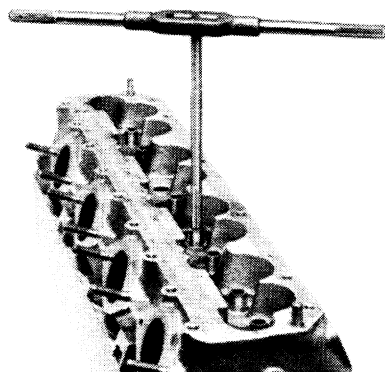

Removing and Installing Valve Springs

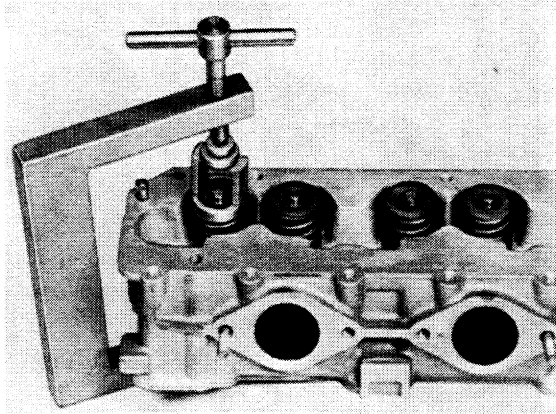

Use Special Tool P 200a to remove and install valve springs

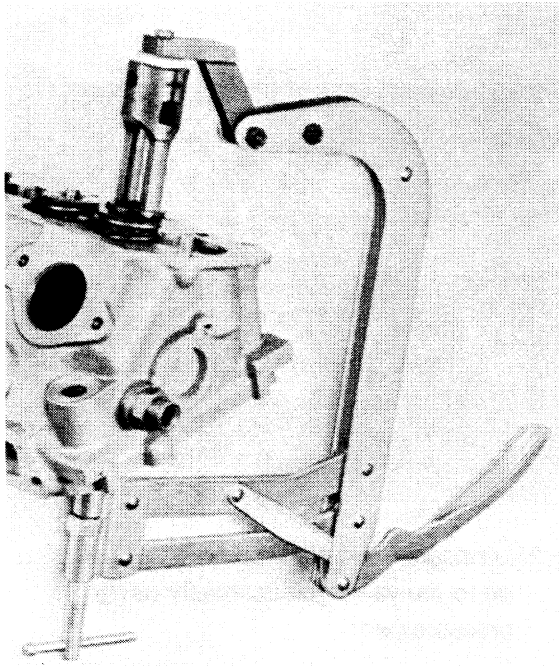

Use Special Tool US 1020 to remove and install valve springs (only for USA).

Checking Installed Length of Valve Springs

1. Install Special Tool 9138/1 with the shims, spring retainer and both collets belonging to a pertinent valve.
2. Read distance on Special Tool 9138/1 and correct by installing or removing shims if applicable. Shims are available in thicknesses of 0.5 and 1.0 mm.

Intake valve	41.0 + 0.5 mm
Exhaust valve	40.0 + 0.5 mm

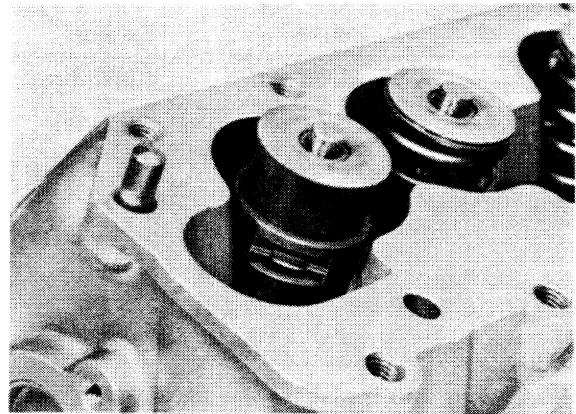

Checking Installed Length of Valve Springs (1985/2 Models)

Note

The bearing surface of valve springs is machined to the same depth since installation of the cylinder head with cast number 944 104 303 7R.

Intake valve	41.0 + 0.5 mm
Exhaust valve	41.0 + 0.5 mm

Valve sizes

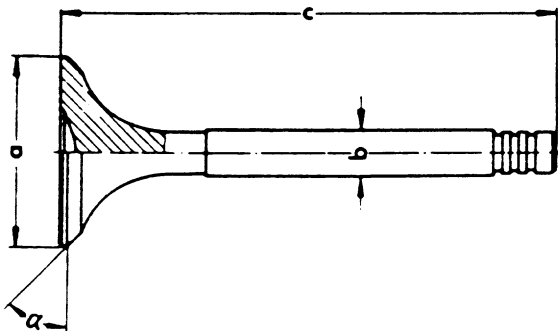

Engine type M 44.01 - 10

Dimension	Intake	Exhaust
a	45.00 mm	40.00 mm
b	8.97 mm	8.95 mm
c	111.50 mm	111.90 mm
α	45°	45°

Engine type M 44.11/12 (2.7 l)

a	48.00 mm	40.00 mm
---	----------	----------

Removing and installing the valve stem seal

(Cylinder head removed)

Pull off valve stem seals with Special Tool 3047

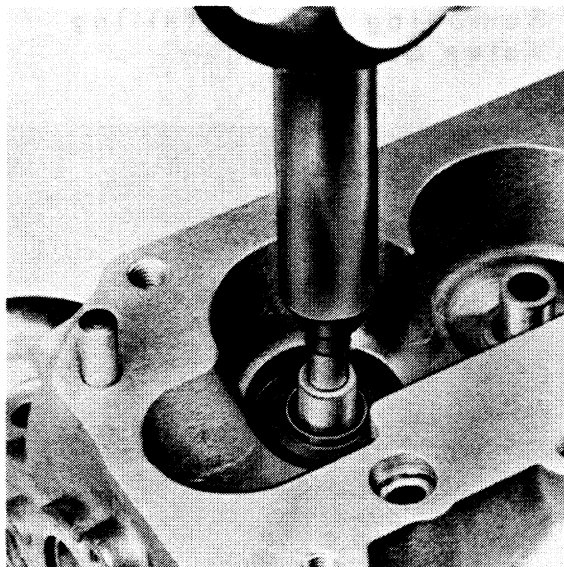
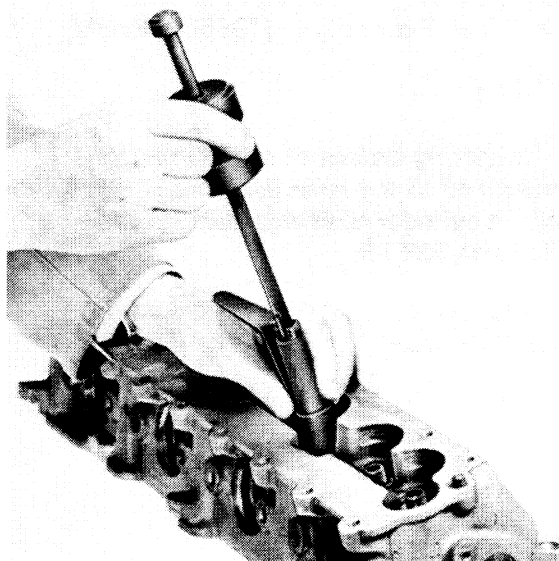

1. Slide the plastic assembly sleeve, e.g. from the spare parts valve stem seal kit for Type 924, onto the valve stem.

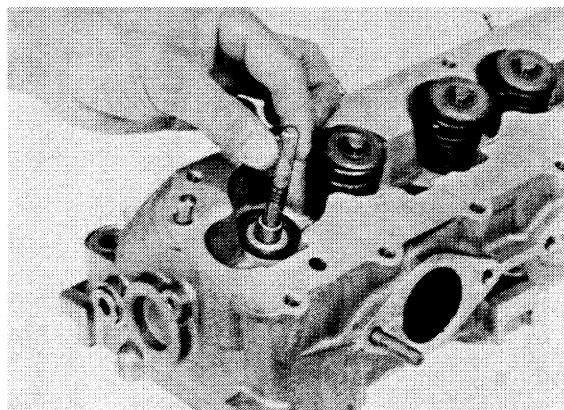

2. Lubricate valve stem seal with oil and slide on to the valve guide carefully using the pressure pad.

Machining Valve Seats

Note

Before refacing the valve seats, check dimension "A" to avoid carrying out work that may be unnecessary since the wear limit has been exceeded.

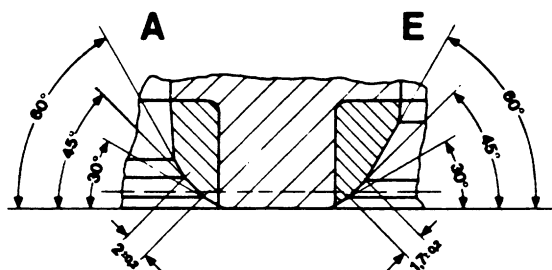
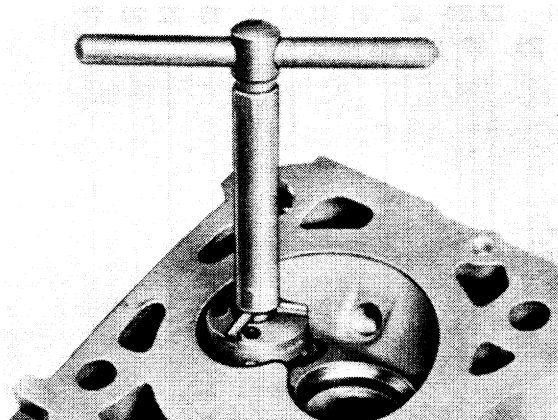

Valve seats may be machined until the wear limit distance "A" = 14,5 mm is reached.
(New part size: $13,65 \pm 0,45$ mm)

If applicable test with a new valve.
Distance "A" must not be exceeded, since otherwise the function of the hydraulic valve tappet could not be guaranteed.

The amount of metal removed should be limited to an absolute minimum, to prevent premature wear of part.

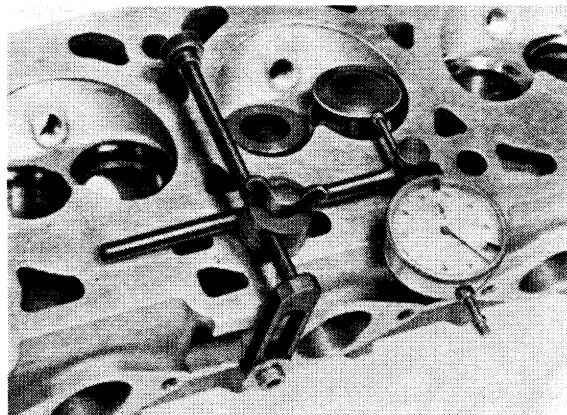

Checking valve guides

1. Remove remainders with a cleaning reamer.
2. Place a new valve in valve guide and make sure that valve stem end is flush with mating surface of cylinder head/camshaft housing.

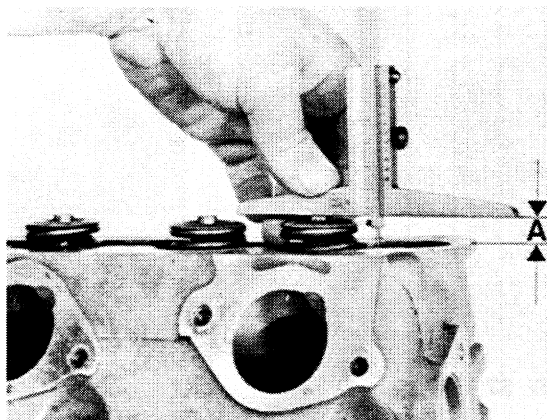

3. Check clearance with a dial gauge in dial gauge holder VW 387.
Wear limit = 0,8 mm

DISASSEMBLING AND ASSEMBLING VALVE DRIVE (CAMSHAFT HOUSING)

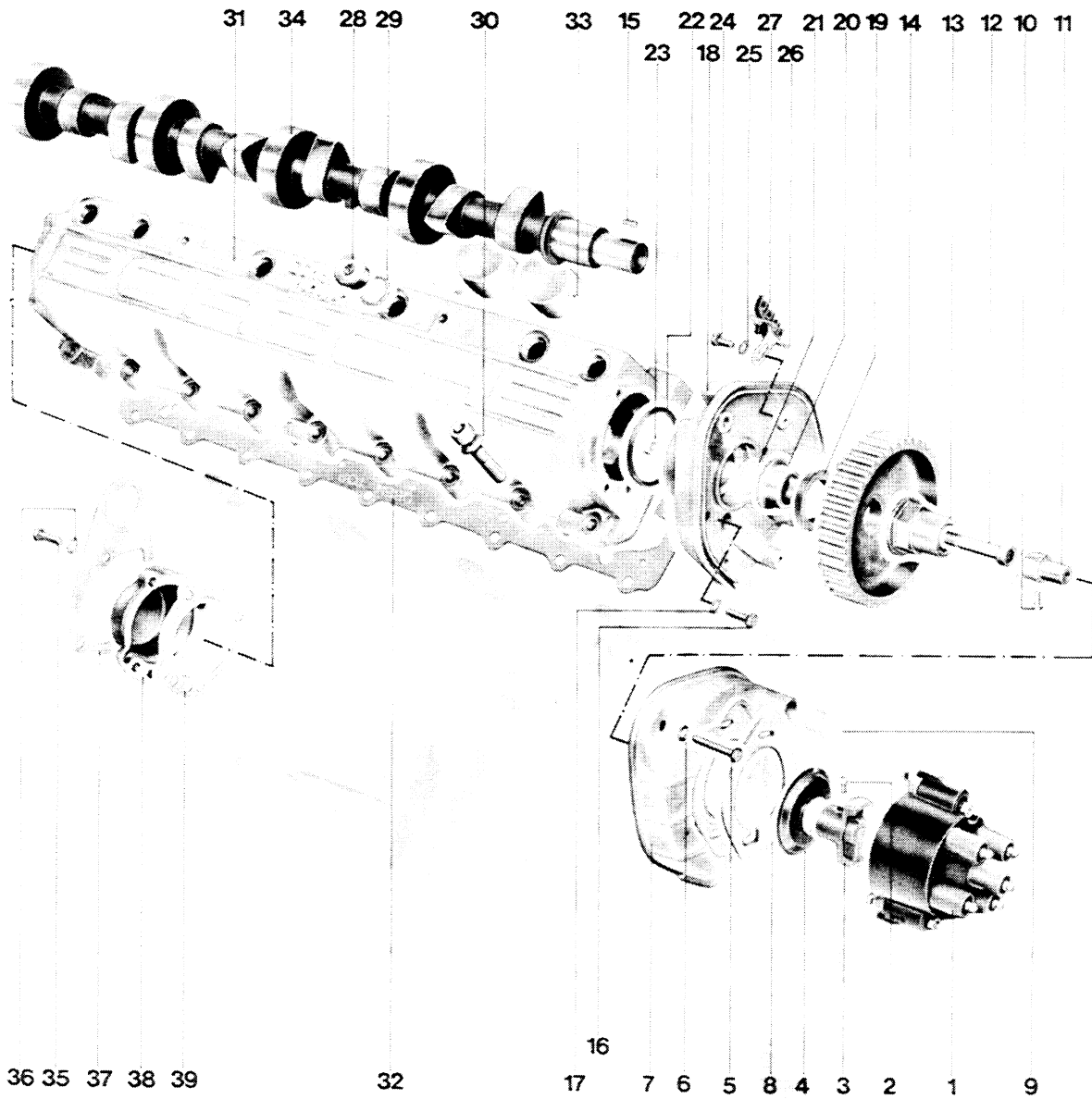

No.	Description	Qty.	Note When:		Special Instructions
			Removing	Installing	
1	Distributor cap	1			
2	Bolt M 4 x 6	1		Lock with Loctite 221	
3	Distributor rotor	1			
4	Dust cap	1		Position correctly	
5	Bolt M 6 x 30	3			
6	Washer 6.4	3			
7	Console for distributor cap	1			
8	Gasket (self- adhesive)	1			
9	End cap for sight hole	1			
10	Bolt M 5 x 10	1		Lock with Loctite 221	
11	Connector	1			
12	Bolt M 10 x 65 Hex. socket bolt Polygon head bolt	1	Hold dog	Same as for removal Torque: 45 Nm 65 Nm	Only use polygon head bolts for re- pairs
13	Dog	1			
14	Camshaft sprocket	1		Note position when installing toothed belt	

No.	Description	Qty.	Note When:		Special Instructions
			Removing	Installing	
15	Woodruff key 4 x 4	1			
16	Bolt M 6 x 35	3			
17	Washer	3			
18	Camshaft bearing cap	1			
19	Shaft seal 30 x 47	1		Replace, lubricate sealing lip, knock in with Special Tool 9202	
20	Spacer	1			
21	Gasket (formerly O-ring in spacer)	1		Replace	
22	O-ring 50 x 5	1		Replace, lubricate lightly	
23	Seal	1			
24	Bolt M 6 x 12	1			
25	Washer	1			
26	Ignition cable holder	1			
27	Ignition cable holder	1			

No.	Description	Qty.	Note When:		Special Instructions
			Removing	Installing	
28	Plug M 18 x 1.5	6			
29	Seal A 18 x 22	6			
30	Bolt with non-removable washer	15		Torque: 20 Nm (14 ft lb)	
31	Camshaft housing	1		Lubricate bearings of camshaft	
32	Gasket for camshaft housing	1		Always replace. Note "TOP" when installing	
33	Hydraulic valve tappet	8	Store so that oil bore faces up, do not mix up	Check	
34	Camshaft	1			
35	Bolt M 6 x 22	3			
36	Washer B 6	3			
37	Transport bracket	1			
38	Cover	1			
39	Gasket	1		Replace	

INSTALLING SHAFT SEAL ON CAMSHAFT BEARING COVER

Note

Shaft seal is an identical part with shaft seal for upper balance shaft.

The shaft seal (32 x 47 x 7, as of May, 1985) and the spacer of the camshaft are no longer identical with the seal and the spacer of the upper balance shaft.

Code (arrow) faces in turning direction of camshaft.



Lubricate sealing lip with oil and install together with spacer, and drive in with Special Tool 9202.

FITTING DISTRIBUTOR ROTOR

Note

Distributor rotor, connector and hex socket bolt are adhered to each other.

Applicable from: September 1982

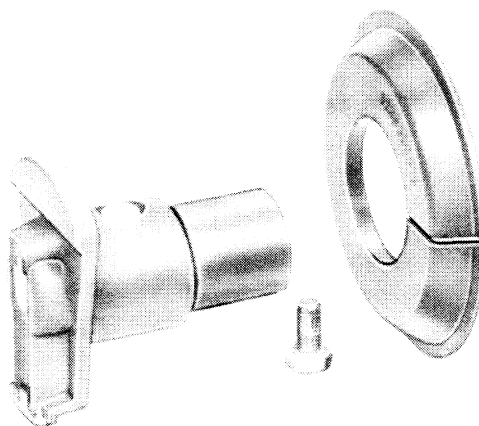

1. Secure distributor rotor with micro-encapsulated hexagon screw.

Torque: 4 Nm

Hexagon screw must only be used once or, when re-used, must be locked with "Loctite 221".

2. Attach dust cap.
Cut open new cap and adhere lightly to brackets quick-action adhesive.

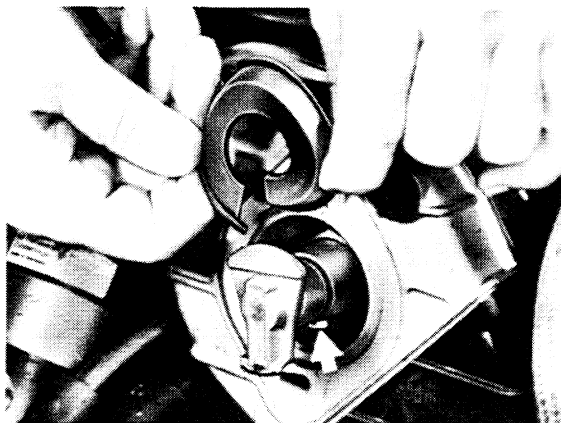

DISASSEMBLING AND ASSEMBLING CAMSHAFT DRIVE

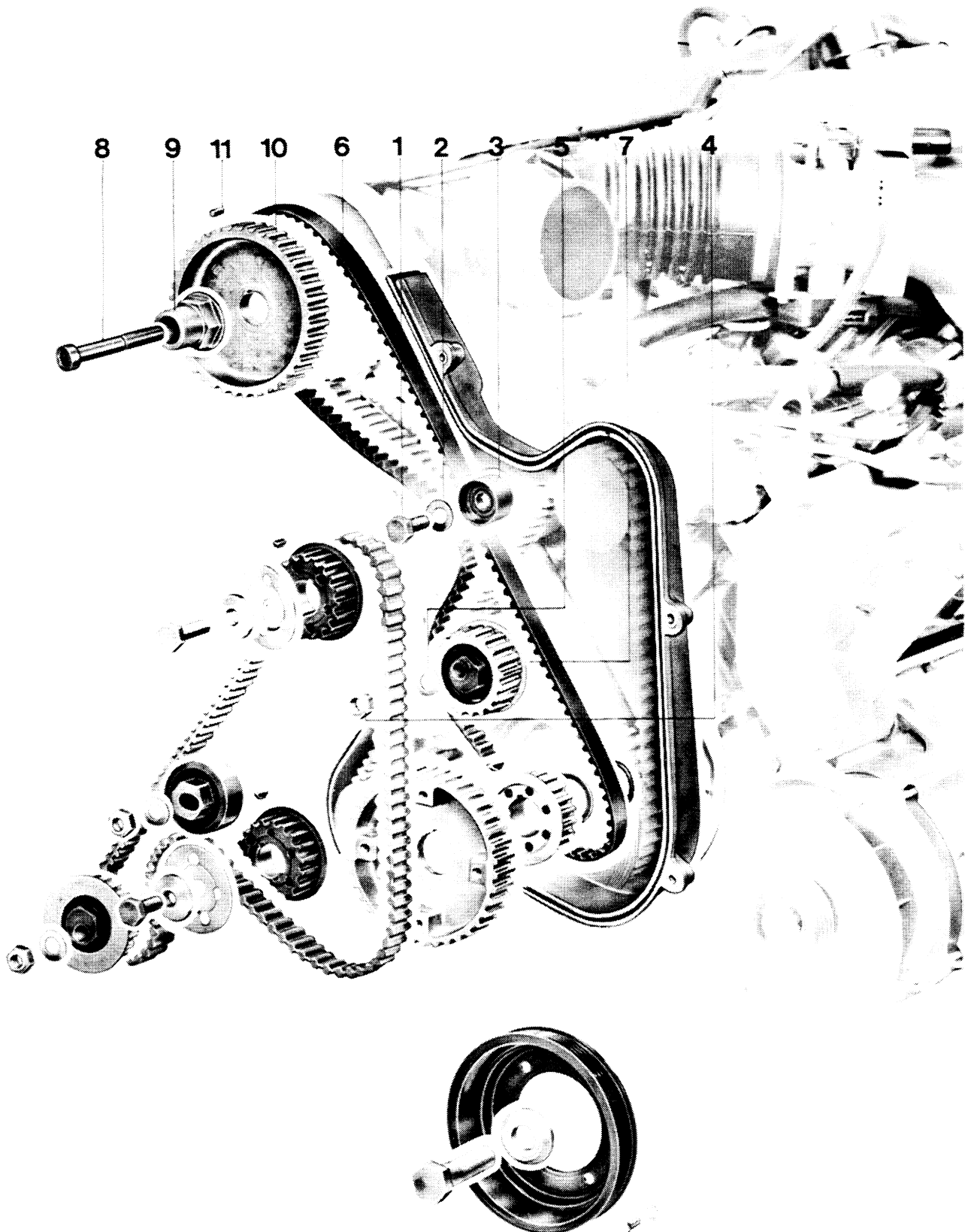

No.	Description	Qty.	Note When:		Special Instructions
			Removing	Installing	
1	Hexagon head bolt M 10 x 35	1			
2	Washer A 10.5	1			
3	Roller	1		Check	
4	Hexagon nut	1			
5	Washer A 10.5	1			
6	Camshaft drive belt	1	Mark to have same running direction when installed again	Check for wear and damage	
7	Tensioning roller	1		Check	
8	Socket head bolt M 10 x 65 (hex.) or Socket head bolt M 10 x 65 (multiple)	1	Hold on dog with Special Tool 9205 Unscrew with stan- dard screwdriver socket and hold on dog	Same as for removal; torque: 45 Nm Torque: 65 to 70 Nm	Only use mul- tiple socket head bolt for repairs
9	Dog	1			
10	Camshaft sprocket	1		Note position when installing drive belt	
11	Woodruff key 4 x 4	1			

Disassembling and assembling camshaft drive

Installing camshaft housing

Note

1. It is essential that cylinder no. 1 be at TDC and the camshaft sprocket aligned with mark to install a complete camshaft housing, since otherwise valves could be damaged.
2. Never crank engine as long as camshaft belt is off or not tightened, since valves could also be damaged.

Special note on toothed belts and drive belts

As a rule, make sure the toothed belts and drive belts are **not kinked** during assembly, packaging and storage. Improper handling may cause incipient damage to the camshaft toothed belts and may lead to engine damage.

Camshaft- Installation	Worldwide		
Engine type 944 As from Model 82	M 44. 01 - 0.4	M 44. 05 - 10	M 44. 11/12 (2.7 l)
Camshaft	944.105.155.05	944.105.155.09	944.105.155.10
Identification code between exhaust and intake cams on cylinder 2	155.05	155.09	155.10
Valve timing 1 mm stroke, zero play			
Intake opens	1° CS after TDC	1° CS after TDC	1° CS after TDC
Intake closes	49° CS after BDC	49° CS after BDC	49° CS after BDC
Exhaust opens	43° CS before BDC	47° CS before BDC	47° CS before BDC
Exhaust closes	3° CS before TDC	1° CS after TDC	1° CS after TDC

Adjusting camshaft belt with mechanical belt tensioner

Model 87 onward
Engine type 44.40/41/05-12

Note

The belt must only be checked and adjusted when the engine is cold (room temperature).

1. Turn crankshaft slowly clockwise until TDC marking (cylinder 1) on the camshaft drive wheel is level with the marking on the rear belt cover.

Illustration shows 16-valve engine

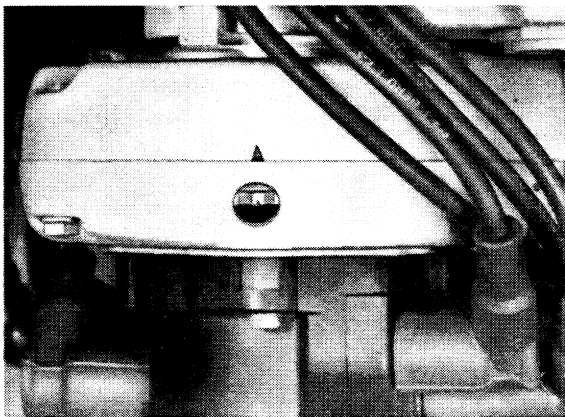

86/460

Note

While turning, check belt for wear and damage.

2. The TDC marking on the flywheel must also be in line.

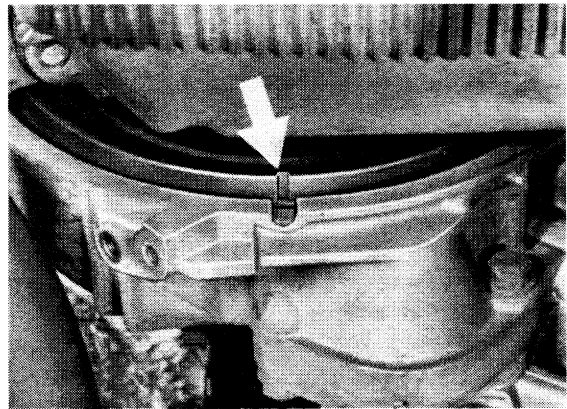

10083

Adjusting

3. Undo nut A and screw B.

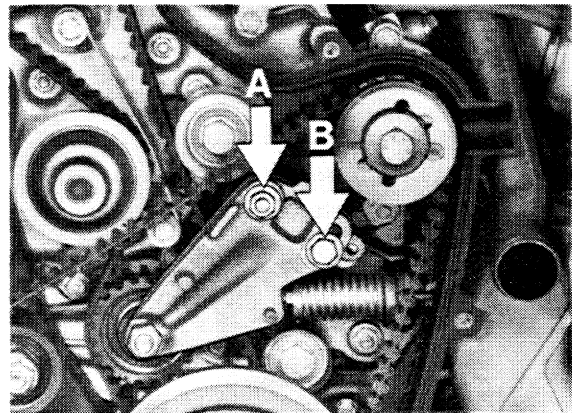

86/488

4. Check mobility of the tensioning roller lever with thumb pressure on the toothed side of the drive belt between camshaft pulley and deflection roller (water pump).

5. Tighten nut A and screw B. It is no longer necessary to measure the belt tension.

Tightening torque 20 Nm.

Do not turn the crankshaft while nut A and screw B are undone.

Note

The belt tensioner can be released using Special Tool 9200.

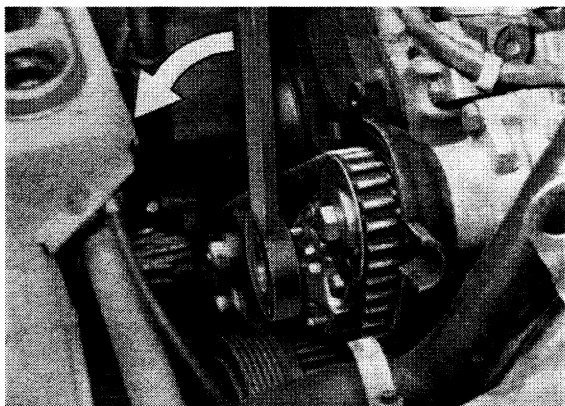

87/692

Do not adjust the spring tension. The belt tensioner must be removed from the upper crankcase section complete when fitting and removing the belt.

Note

Idle-pulley width of the belt tensioner

16-VALVE

2-VALVE

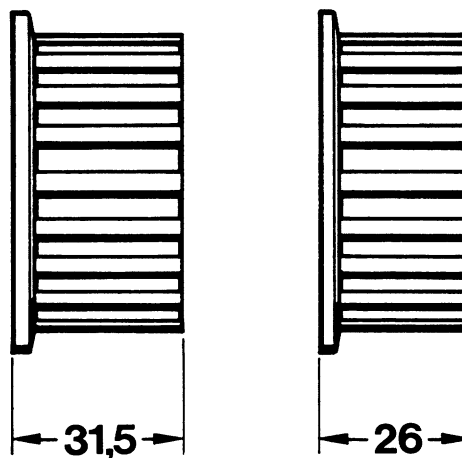

159-15

REPLACING ENGINE OIL AND ENGINE FILTER

Requirements:

Engine at operating temperature.

1. Unscrew oil drain plug on oil pan and drain engine oil.

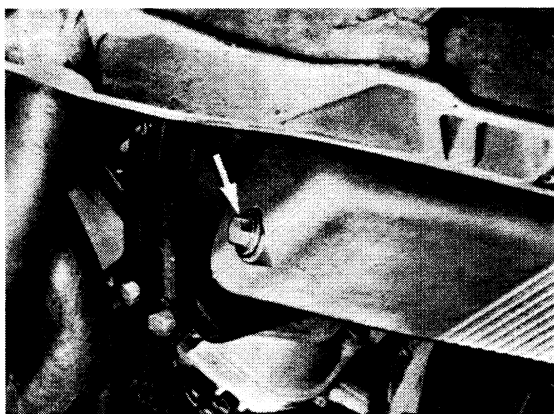

2. Loosen oil filter with a standard oil filter wrench (e.g. from Mann & Hummel with designation LS 7). Catch escaping oil.

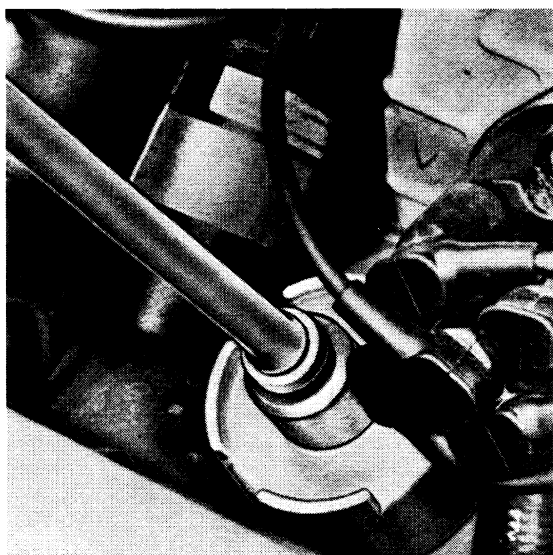

3. Clean drain plug. Replace seal. Tightening torque of drain plug: 60 Nm (43 ft lb).

4. Give gasket on oil filter a light coat of oil. Screw on filter by hand until gasket contacts, tighten by one further turn and finally recheck tightness of filter with the oil filter wrench.

Specified tightening torque: 20 Nm (14 ft lb).

5. Add engine oil. Run engine to operating temperature and check for leaks.

6. Check oil level on stopped engine.

CHECKING ENGINE FOR LEAKS

Visual Inspection

TOOLS

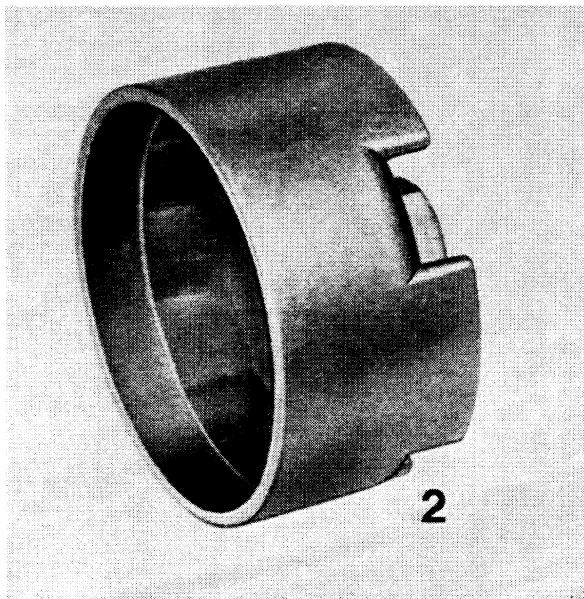
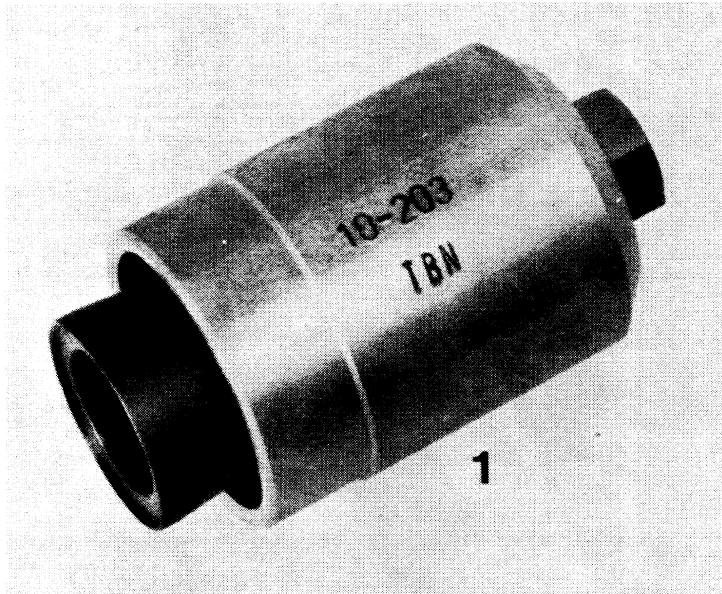

No.	Description	Special Tool	Remarks
1	Pressure pad	10 - 203	Only use outer part
2	Oil filter wrench	9204	

REPLACING ENGINE OIL AND ENGINE FILTER

Requirements:

Engine at operating temperature.

1. Unscrew oil drain plug on oil pan and drain engine oil.

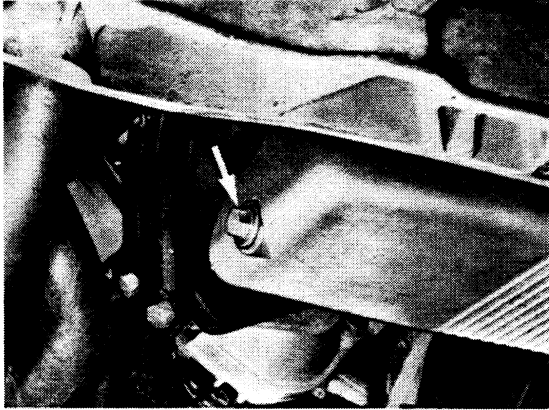

2. Loosen oil filter with a standard oil filter wrench (e.g. from Mann & Hummel with designation LS 7). Catch escaping oil.

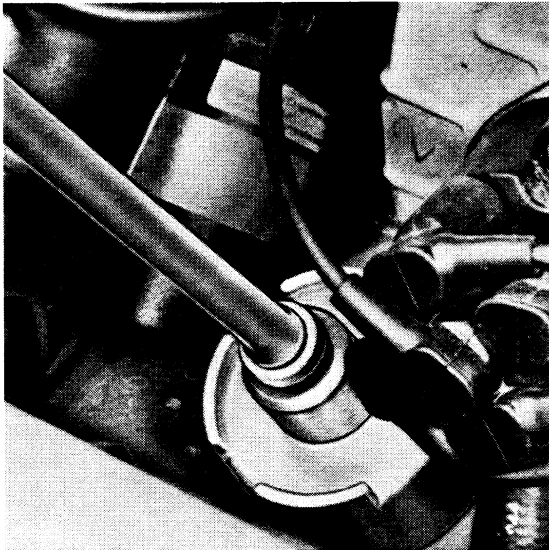

3. Clean drain plug. Replace seal. Tightening torque of drain plug: 60 Nm (43 ft lb).

4. Give gasket on oil filter a light coat of oil. Screw on filter by hand until gasket contacts, tighten by one further turn and finally recheck tightness of filter with the oil filter wrench.

Specified tightening torque: 20 Nm (14 ft lb).

5. Add engine oil. Run engine to operating temperature and check for leaks.

6. Check oil level on stopped engine.

CHECKING ENGINE FOR LEAKS

Visual Inspection

TOOLS

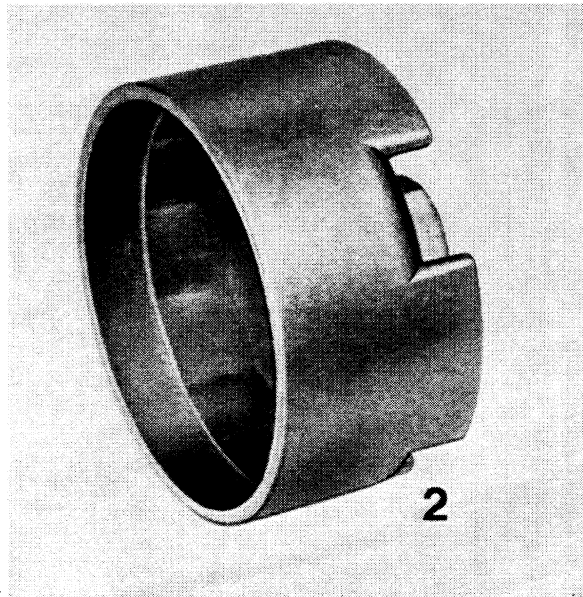
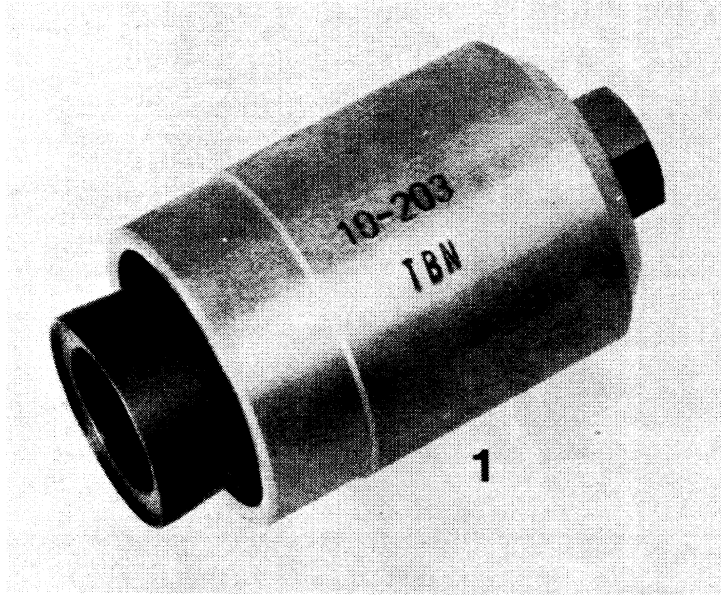

No.	Description	Special Tool	Remarks
1	Pressure pad	10 - 203	Only use outer part
2	Oil filter wrench	9204	

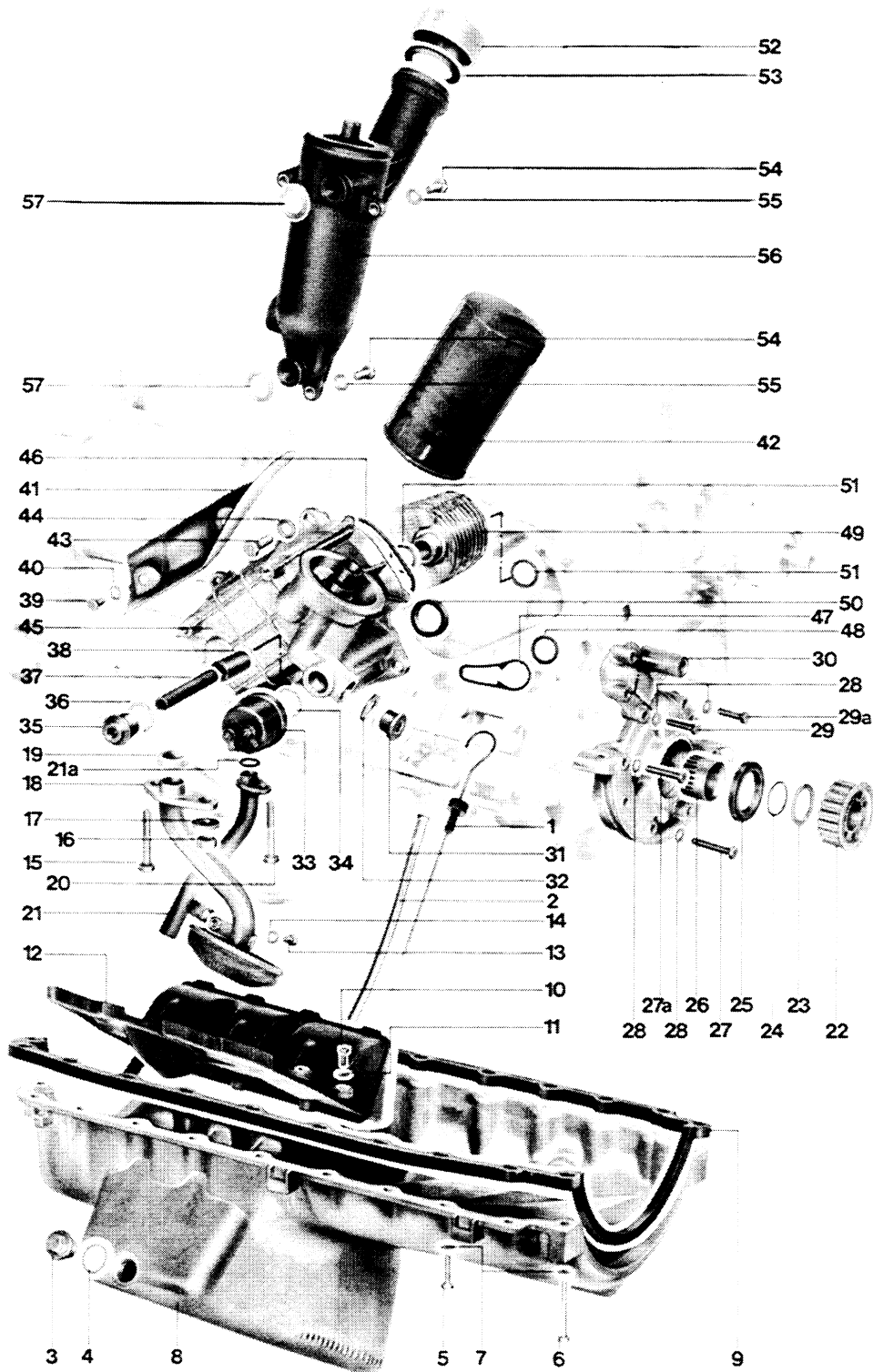

No.	Description	Qty.	Removing	Note When: Installing	Special Instructions
1	Oil dipstick	1			
2	Guide tube	1		Install with Loctite 638	
3	Plug M 20 x 1.5	1		Torque: 50 Nm (36 ft lb)	
4	Seal	1		Replace	
5	Bolt M 6 x 25	18		Note tightening procedures	see page 17 - 9
6	Bolt M 6 x 50	4		Note tightening procedures	see page 17 - 9
7	Washer	22			
8	Oil pan	1	Caution! Do not damage oil intake pipe when removing		
9	Gasket	1		Check, replacing if necessary	
10	Bolt M 5 x 12	7		Lock with Loctite 270	
11	Washer	7			
12	Oil pan insert	1		Open oil pan insert tabs and clean inside	
13	Bolt M 6 x 10	1		Lock with Loctite 270	
14	Washer	1			
15	Bolt M 8 x 55	1			
16	Nut M 10	1		Torque: 50 Nm (36 ft lb)	
17	Washer	1			

No.	Description	Qty.	Note When:		Special Instructions
			Removing	Installing	
18	Oil intake pipe	1			
19	Seal	1		Always replace	
20	Bolt M 8 x 50	1			
21	Oil drain pipe	1			
21a	O-ring	1			
22	Camshaft drive gear	1		Belt collar faces balance shaft drive gear	
23	Thrust washer	1			
24	Seal	1		Replace	
25	Shaft seal	1		Replace	see page 17 - 9
26	Sleeve	1			
27	Bolt M 6 x 45	3			
27a	Bolt M 6 x 50	2			
28	Washer	9			
29	Bolt M 6 x 35	4			
29a	Bolt M 6 x 40	1			
30	Oil pump assy.	1		If oil pump is disassembled, coat outside diameter on housing insert before installing in pump housing with Loctite 574. Coat sealing surface with Loctite 574	
31	Plug M 18 x 1.5	1		Torque: 35 Nm (25 ft lb)	
32	Seal	1		Replace	
33	Oil pressure sensor M 18 x 1.5	1		Torque: 35 Nm (25 ft lb)	

No.	Description	Qty.	Note When:		Special Instructions
			Removing	Installing	
34	Seal	1		Replace	
35	Plug for pressure relief valve M 20 x 1.5	1		Torque: 45 Nm	
36	Seal	1		Replace	
37	Spring	1			
38	Piston for pressure relief valve	1		Check for wear and seizure traces, replacing piston if necessary	
39	Bolt M 6 x 12	2			
40	Washer	2			
41	Cover	1			
42	Oil filter	1		Give seal a light coat of oil; torque: 20 Nm	
43	Bolt M 8 x 25	4			
44	Washer	4			
45	Housing	1			
46	Seal	1		Replace, coat groove in case with Curil T	
47	Gasket	1		Replace, coat groove in case with Curil T	
48	Seal	1		Replace, coat groove in case with Curil T	
49	Oil/water cooler	1		Pre-assemble in housing and mount together with crank-case upper section	

No.	Description	Qty.	Note When:		Special Instructions
			Removing	Installing	
50	Rubber ring	1		Replace and paste on crankcase upper section with Loctite 638	
51	Seal	2		Replace and lubricate lightly	
52	Oil filler cap	1			
53	Seal	1		Check, replacing if necessary	
54	Bolt M 8 x 20	3			
55	Washer A 8.4	3			
56	Oil trap	1	Remove intake distributor for this purpose		
57	Seal 20 x 5	2		Replace	

REMOVING AND INSTALLING PARTS OF LUBRICATING SYSTEM

Remove housing insert.

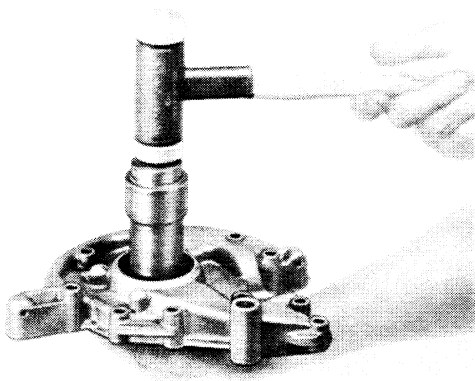

Punch mark (on outer rotor) faces out.

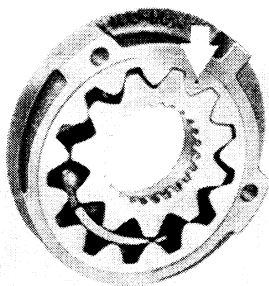

Align oil pump body surface with upper crankcase section before tightening the mounting bolts.

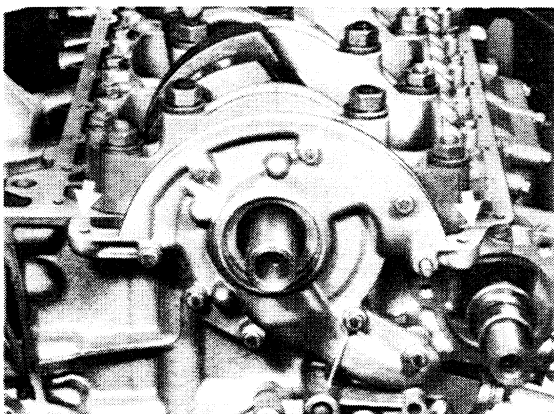

Apply toothed sleeve on sealing lip and seal simultaneously and drive in with Special Tool 10 - 203 (only outer part).

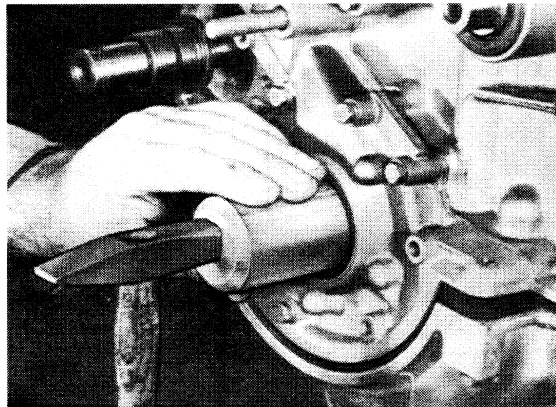

Coat both sides of gasket in area of corners with engine oil prior to installation of the oil pan gasket.

Various modifications have been made on the oil pump and crankcase beginning with 1985/2 models. Consequently the new oil pump, Part No. 944 107 014 08, must not be installed in older engines.

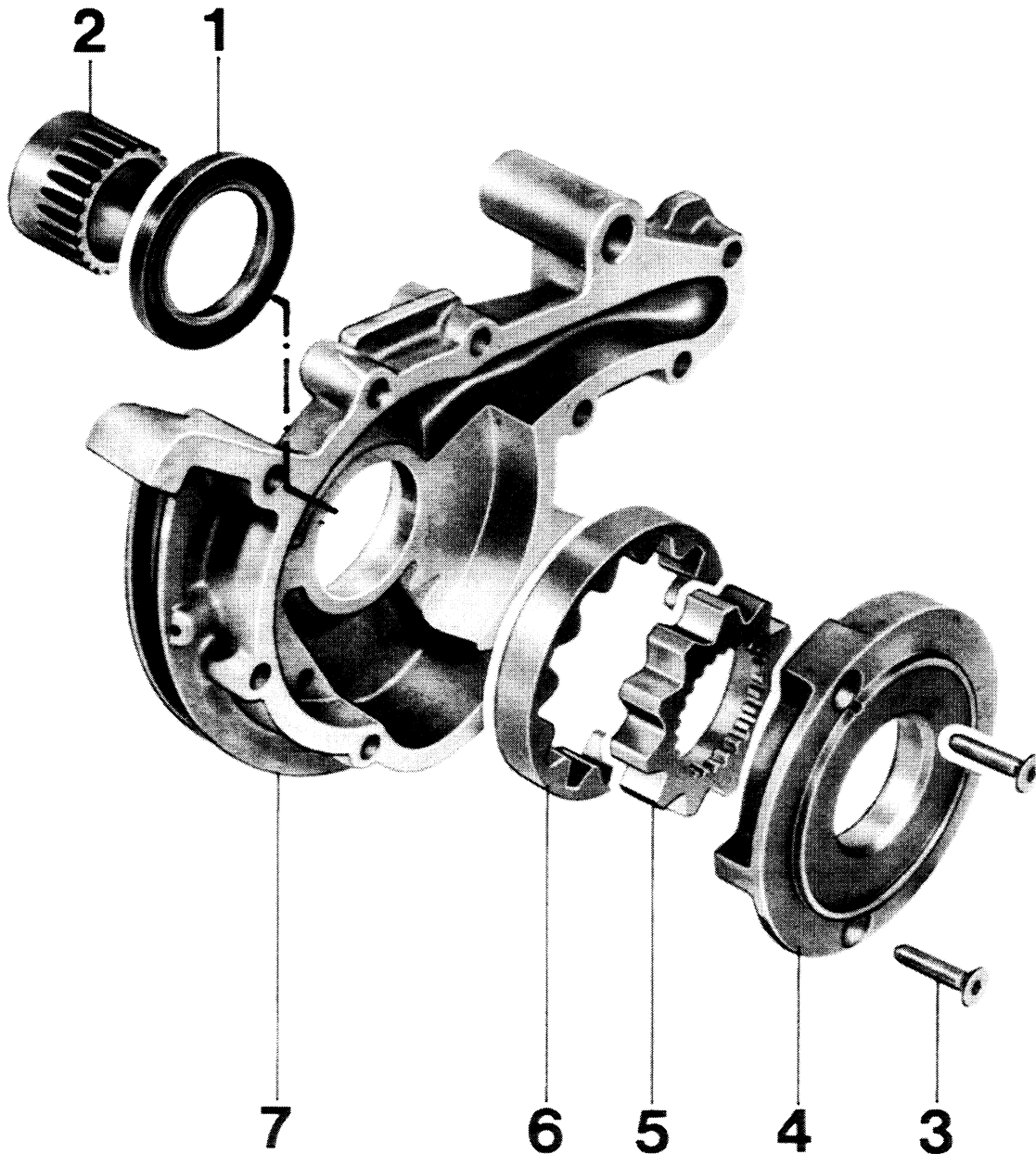
DISASSEMBLING AND ASSEMBLING OIL PUMP

No.	Description	Qty.	Note When:		Special Instructions
			Removing	Installing	
1	Shaft seal 38 x 55 x 7	1		Replace, lubricate lip with oil, install seal together with toothed sleeve and drive in with tool 10-203 (only outer part)	
2	Toothed sleeve	1			
3	Countersunk screw M 6 x 25	2		Torque: 8 Nm (6 ft lb)	
4	Housing insert	1		Apply coat of Loctite No. 574 on outside diameter of housing insert over entire width before installing	
5	Inner rotor	1		Lubricate with oil	
6	Outer rotor	1		Lubricate with oil; punch mark faces out	see page 17 - 9
7	Oil pump housing	1		Coat face end with Loctite No. 574	

REMOVING AND INSTALLING BUSHING FOR OIL PRESSURE RELIEF VALVE

Removing

Remove damaged bushing by unscrewing with grip pliers.

2. Drive in bushing to stop with Special Tool 9215.

Note

Be careful not to damage crankcase.

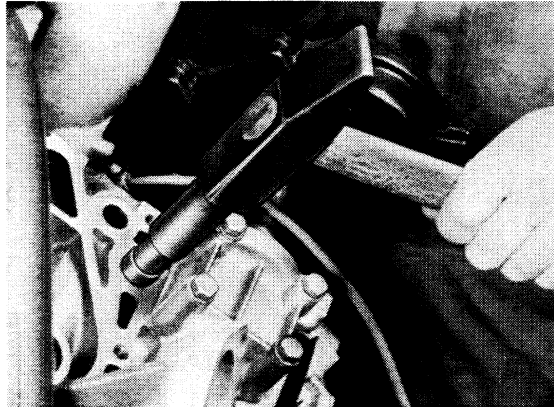
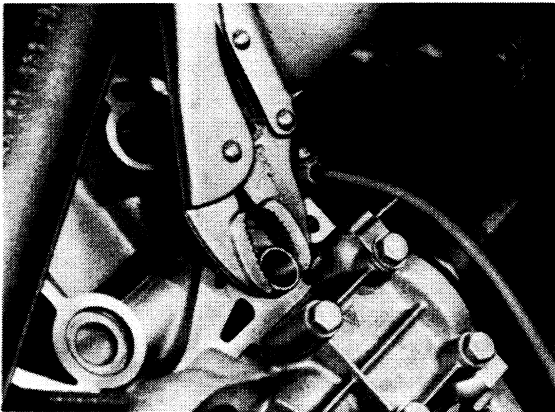

Installing

1. Coat bushing at lower scored surface with Loctite No. 648 or 638.

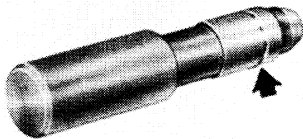

TIGHTENING PROCEDURES FOR OIL PAN MOUNTING BOLTS

1st step: install bolts

2nd step: 4 Nm (3 ft lb)

3rd step: 8 Nm (6 ft lb)

Tightening sequence: clockwise from inside to outside.

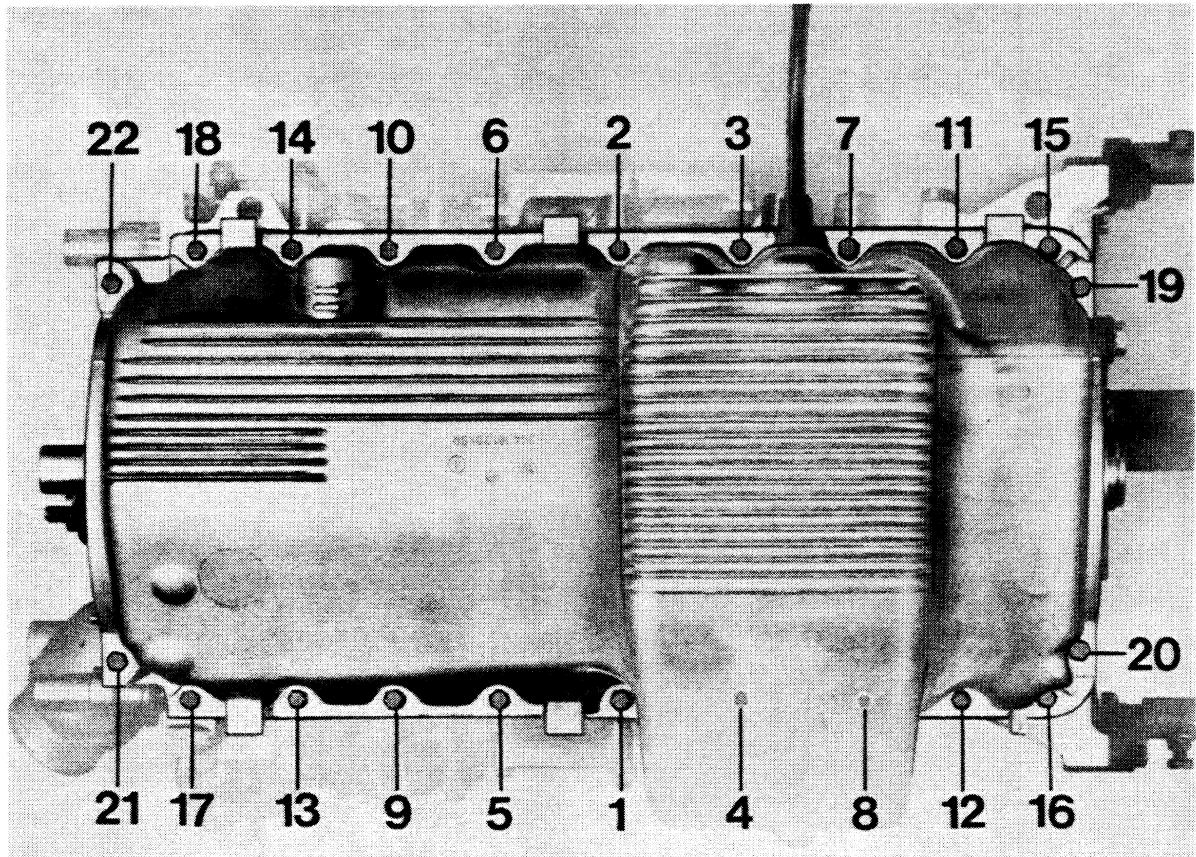

TOOLS

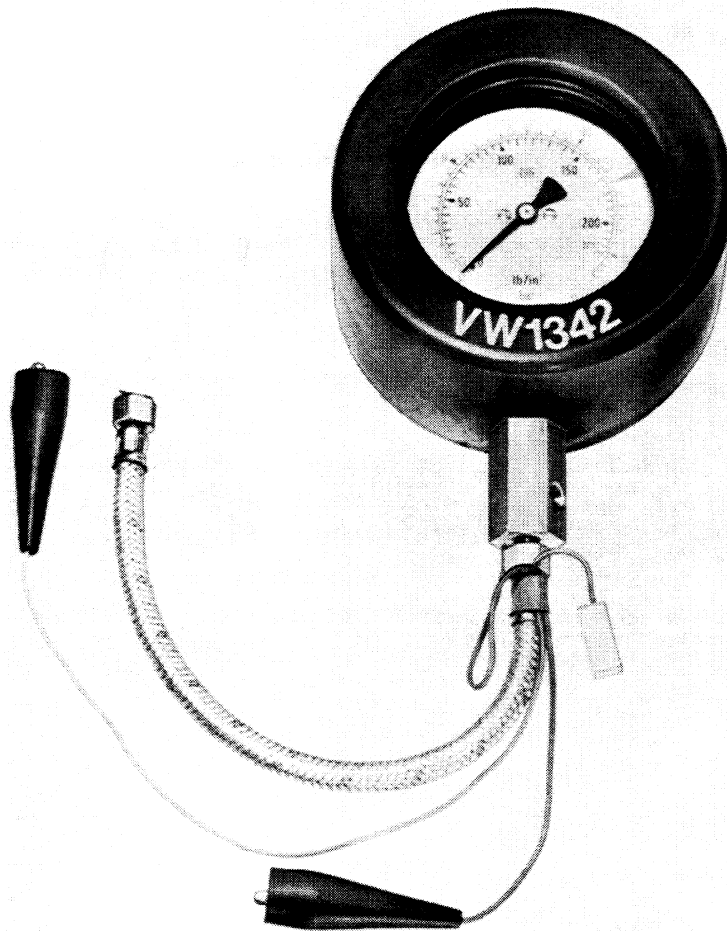

No.	Description	Special Tool	Remarks
	Oil pressure tester	VW 1342	

CHECKING OIL PRESSURE

1. Remove oil pressure transmitter and screw oil pressure tester VW 1342 together with M 10 x 1 adapter, Part No. 999.105.013.02, and M 10 x 1/M 18 x 1.5 adapter, Part No. 901.101.175.01, in its place in the oil/water cooler housing.

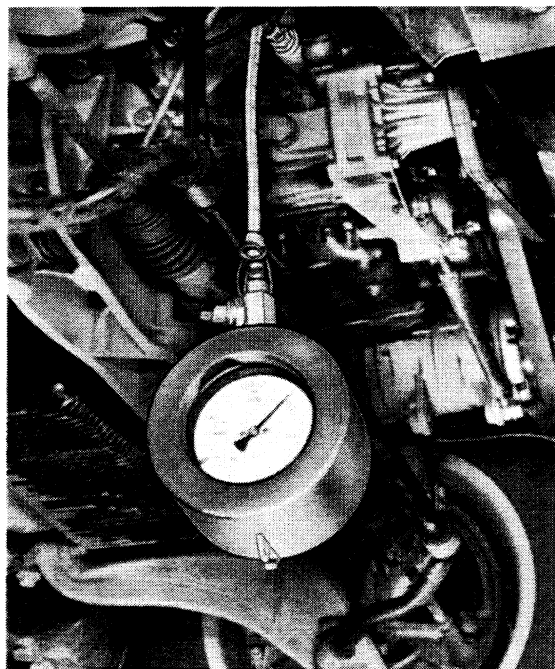

2. Run engine to operating temperature (80° C oil temperature), checking the temperature with, for example, an oil temperature tester (Special Tool 9122 + 9122/2).

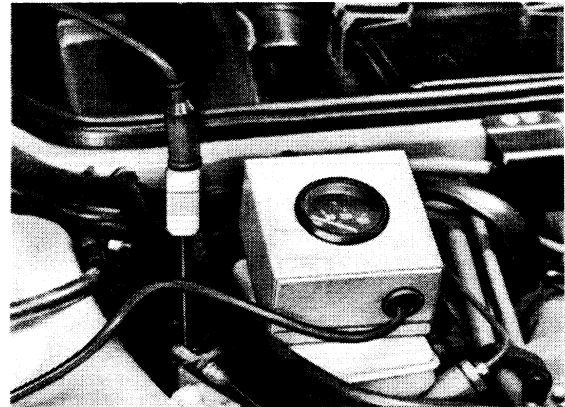

3. At idle speed the oil pressure should be 2.5 bar or more.
Have a second person accelerate the engine speed to 4000 rpm.
Read oil pressure from tester. The value should be greater than 4.5 bar.
4. Install oil pressure transmitter with a new A 18 x 24 seal. Tightening torque: 35 Nm.

REMOVING AND INSTALLING OIL CHECK VALVE IN CYLINDER HEAD

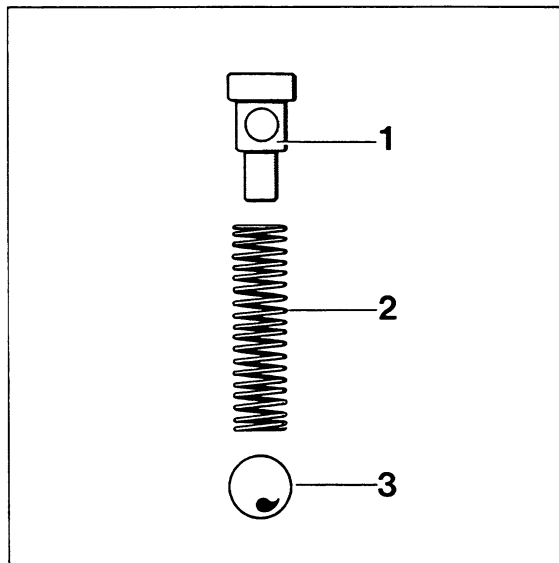

- 1 Guide piece
- 2 Spring
- 3 Ball

Removing

Oil check valve - 944 turbo engine
 Part No. 951 104 229 00
 Identifying feature: \varnothing 2.5 mm bore.

Predrill valve approx. 5 mm deep using a \varnothing 4.8 - 5 mm drill, then cut thread with a commercially available M 6 threaded blind hole drill. Coat drill with grease. Extract valve using an M 6 bolt and a spacer sleeve.

Oil check valve - 944 engine
 Part No. 928.104.131.00
 Identifying feature: \varnothing 8 mm bore.

Cut thread using M 10 threaded blind hole drill. Turn out valve using an M 10 bolt and a spacer sleeve.

Note

When overhauling engines, only the oil check valves from the 944 turbo engine, Part No. 951 104 229 00 should now be installed.

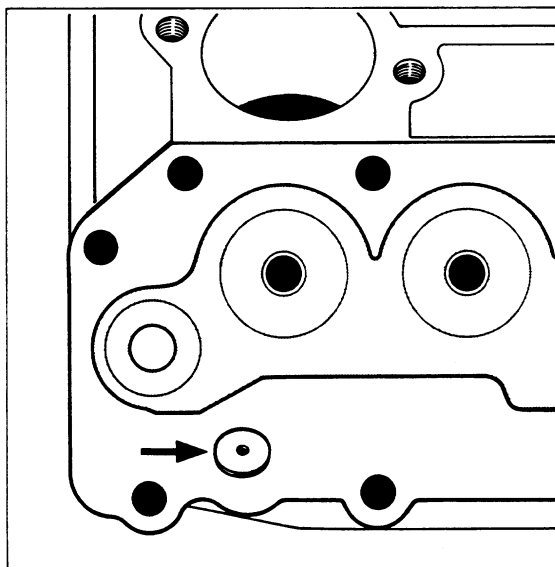

Cleaning the entire engine oil system after an engine failure (bearing failure)

Note

This cleaning sequence is only intended to give pointers as to where you may find chips. The actual amount of work involved will depend on each individual case of engine damage.

Replace the following parts:

- Hydraulic valve tappets
- Chain tensioner (16-valve engine)
- Pressure relief valve (crankcase)
- Pressure reducing valve (cylinder head)
- Oil/water heat exchanger
- Oil filter

The following parts must be dismantled, inspected and cleaned thoroughly:

- Oil pump
- Thermostat housing (turbo)
- Oil/water heat-exchanger housing
- Oil check valve in the cylinder head
see Page 17 - 16

The following parts must be cleaned thoroughly and/or rinsed through repeatedly:

Note:

All oil bores may be rinsed through thoroughly with benzine and a commercially available oil/benzine syringe.

- Oil pan
- Oil intake pipe
- Oil drain pipe
- Crankcase
see Page 17 - 18
- Crankshaft
- Cylinder head
- Camshaft housing
- Oil lines (turbo)
- Oil cooler (turbo)
- Oil separator

Change oil filter and engine oil after approx. 500 km.

Note:

After an engine failure, the entire intake system must be inspected for foreign bodies and/or oil and cleaned before assembly.

Cleaning the main oil duct in the crankcase

Note

Both sealing caps must be removed from the crankcase for this procedure.

Removing

1. Drill a hole in the sealing cap
2. Drive out the sealing cap with a suitable punch.

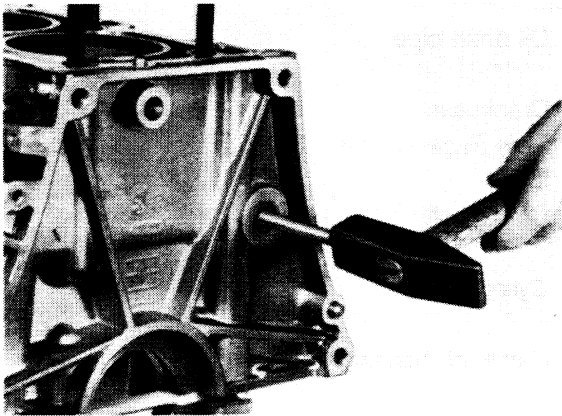

83/8323

2. Drive into a place with a plunger, e.g. VW 295.

Note

The sealing cap must lie approx. 2 - 3 mm below the edge of the housing.

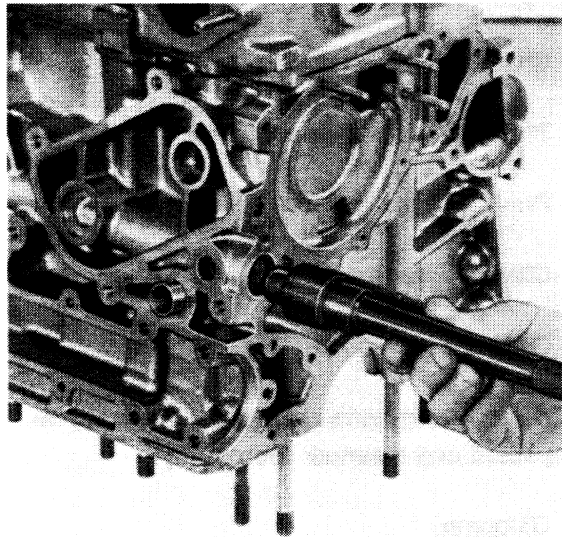

9836

3. Clean and/or flush the main oil duct

Installing

1. Apply film of Loctite 262 to the sealing surface of the cap.

Removing and installing the pressure reducing valve

Engine type M 44. 11/12 (2.7 l)

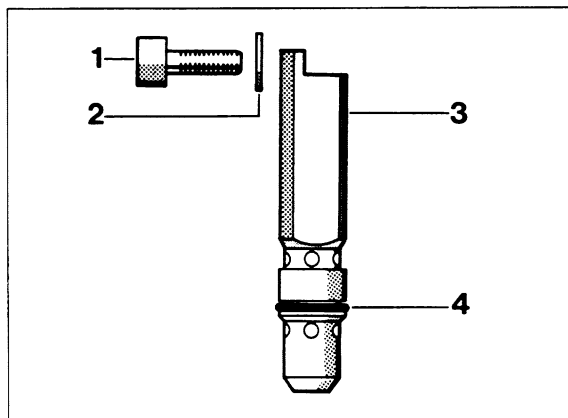

81/17

- 1 - Fillister head screw
- 2 - Gasket
- 3 - Pressure reducing valve
- 4 - O-ring

1. Remove the camshaft housing, undo and remove the fillister head screw.
2. Fit a screw, e.g. M 5 x 30 in the pressure reducing valve from above and pull the valve out of the cylinder head.
3. Replace the O-ring before installation, applying a light film of oil.
4. Install the pressure reducing valve in the correct position, replace the gasket and tighten the fillister head screw.
Tightening torque 8 Nm.

REPLACING COOLANT AND BLEEDING COOLING SYSTEM

1. Drain coolant (only from cold engine). Set heater control lever to „warm” position and unscrew drain plugs on radiator and crankcase.

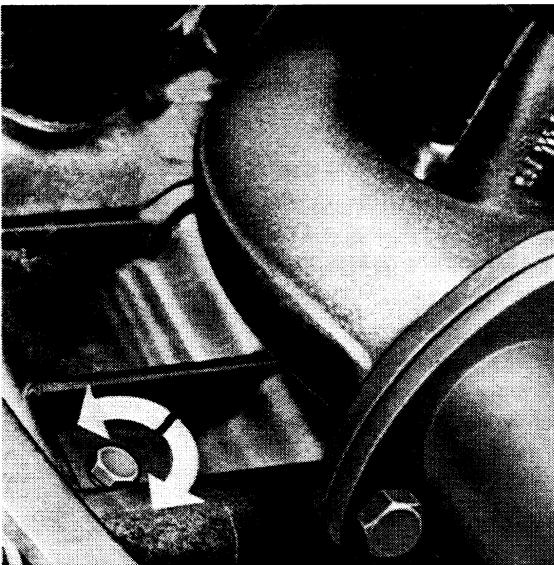
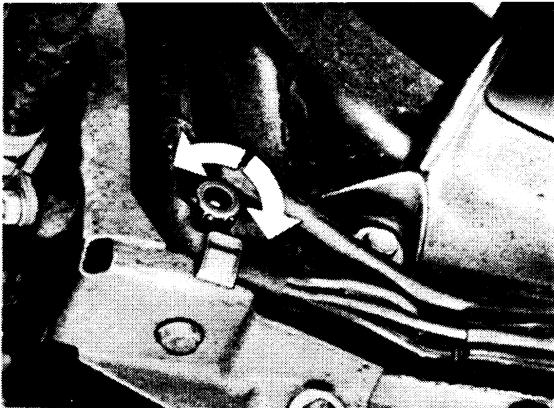

2. Install drain plugs.

Tightening torque:

Radiator 5 Nm (43 in. lb)

Crankcase 20 Nm (14 ft lb)

Leave or set heater control lever to „warm” position and remove bleeder plugs. Add coolant slowly until fluid level in expansion tank is kept at the „max.” mark constantly.

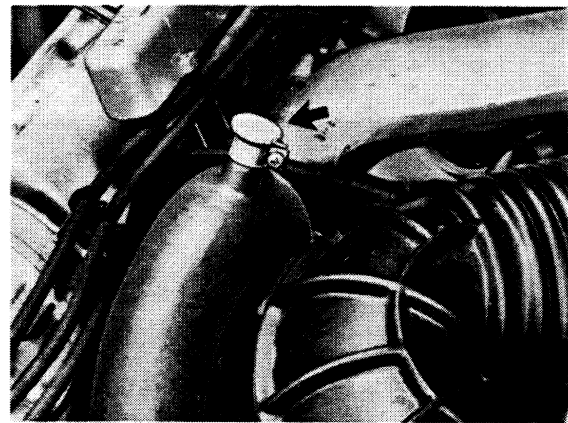

3. Start engine and run to operating temperature at fast idle speed (until radiator fan has switched on and off).

If fluid leaving bleeder opening is without air bubbles, insert plug and tighten hose clamp. Check coolant level, adding more coolant if necessary.

COOLANT MIXING CHART
(Average Values)

Protection to	Antifreeze	Water	Antifreeze	Water
-25° C/ -13° F	40 %	60 %	3.1 ltr./3.3 US qt	4.7 ltr./5.0 US qt
-30° C/ -22° F	45 %	55 %	3.5 ltr./3.7 US qt	4.3 ltr./4.5 US qt
-35° C/ -31° F	50 %	50 %	3.9 ltr./4.1 US qt	3.9 ltr./4.1 US qt

REPLACING COOLANT AND BLEEDING COOLING SYSTEM

(With New Bleeder Adapter)

1. Drain coolant (only when engine is cold).
Set heater lever at "warm" and unscrew drain plugs on radiator and crankcase.

Note

The drain plug in the crankcase has been discontinued as from model 89. Draining facility from the auxiliary plastic connector on the water pump. (For 944 turbo with thermostat insert only).

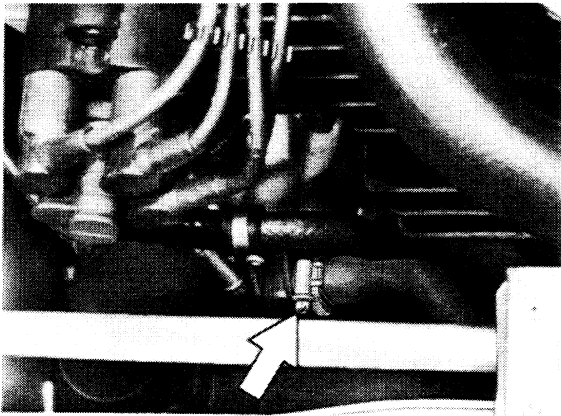

88/150

2. Screw in drain plugs.
Tightening torque:
radiator = 5 Nm (43 in. lb)
crankcase = 20 Nm (14 ft lb)

Leave or set heater lever at "warm" and unscrew bleeder screw.

Add coolant s l o w l y until coolant runs out of bleeder adapter.

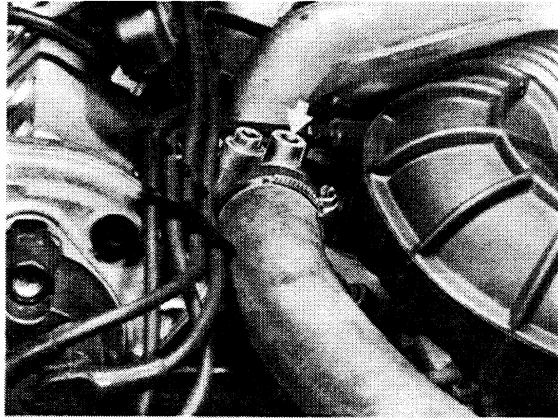

Drain a small amount of coolant again until coolant level reaches approx. half full reservoir mark, so that coolant will not overflow when running engine warms up.

3. Tighten bleeder screw several turns, start engine and run at fast idle speed to reach operating temperature (until radiator fan has switched on and off).

Tighten bleeder screw when escaping fluid does not have air bubbles.

Correct coolant level to reach "max." mark on reservoir.

Check and, if necessary, correct coolant level after test driving car.

CHECKING THERMOSTAT

Place thermostat in a water bath.

Begins to open = approx. $83^{\circ} \pm 2^{\circ} \text{C}$ ($181^{\circ} \pm 3.5^{\circ} \text{F}$)

Fully open = approx. 90°C (194°F)

Opening travel (distance A) = at least 7 mm

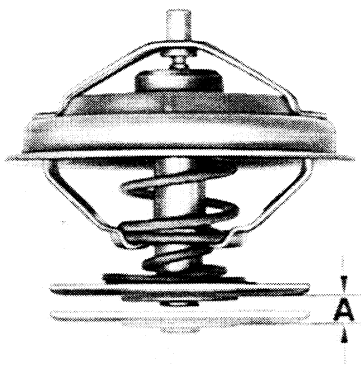

CHECKING COOLING AND HEATING SYSTEM FOR LEAKS

1. Inspect visually for leaks.

2. Check hoses for porosity and brittleness.

3. Tighten hose clamps.

REMOVING AND INSTALLING PARTS OF COOLING SYSTEM

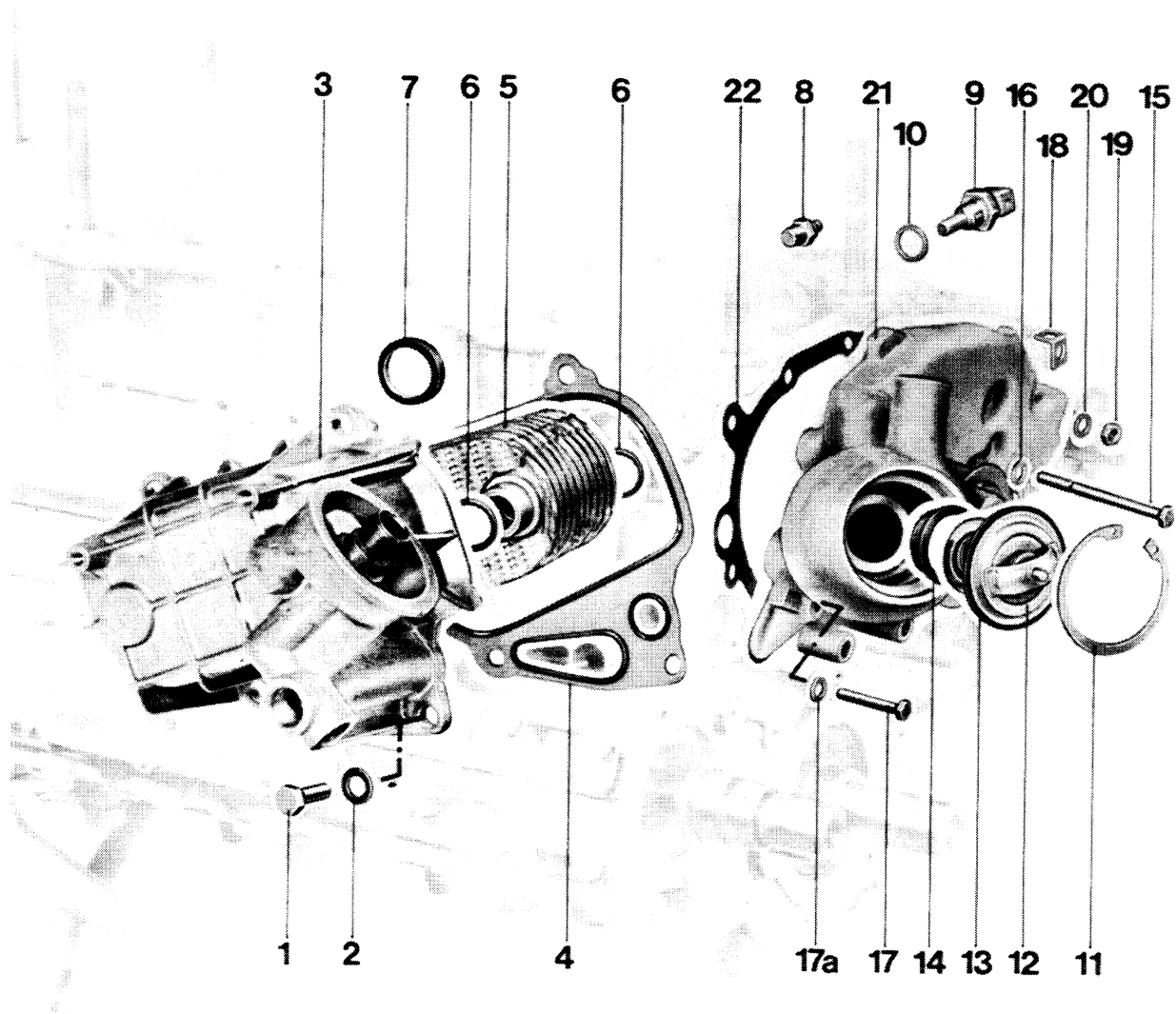

No.	Description	Qty.	Note When:		Special Instructions
			Removing	Installing	
1	Hexagon head bolt M 8 x 25	4			
2	Washer	4			
3	Housing for oil/ water cooler	1			see P. 19 - 6
4	Profile gasket with vulcanized seals	1		Always replace	
5	Oil/water cooler	1		Assemble in housing and mount together on upper crankcase section	
6	Seal	2		Replace, light coat of oil	
7	Rubber ring	1		Replace, check for correct fit in upper crank- case section	
8	Temperature transmitter	1		Torque: 8 Nm (0.8 kpm)	
9	Temperature sensor	1		Torque: 15 Nm (1.5 kpm)	
10	Seal 12 x 18	1		Replace	
11	Circlip	1		Check for cor- rect fit	
12	Thermostat	1		Check	see P. 19 - 3
13	Seal	1		Check	
14	Molded gasket	1			Introduction July, 1983 Engine No. 41 E 00 429 43 E 00 391 43 E 20 138

No.	Description	Qty.	Note When:		Special Instructions
			Removing	Installing	
15	Socket head screw M 6 x 70	1			
16	Washer	1			
17	Socket head screw M 6 x 35	7			
17a	Washer	7			
18	Bracket	1			
19	Hexagon nut M 6	3			
20	Washer	3			
21	Water pump, assembly	1			
22	Gasket	1		Replace	

REMOVING AND INSTALLING PARTS OF COOLING SYSTEM

1. Place assembled oil/water cooler housing on upper crankcase section. Insert Special Tool 9215 in guide sleeve for oil pressure relief valve.

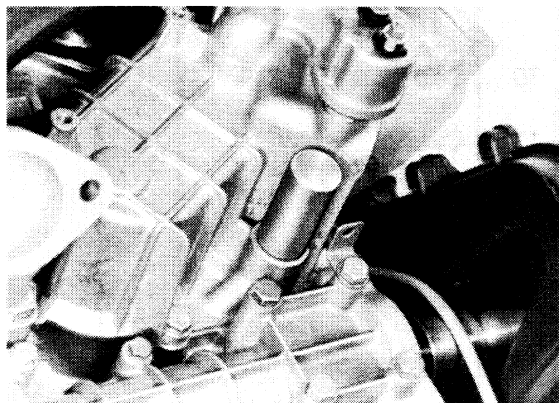
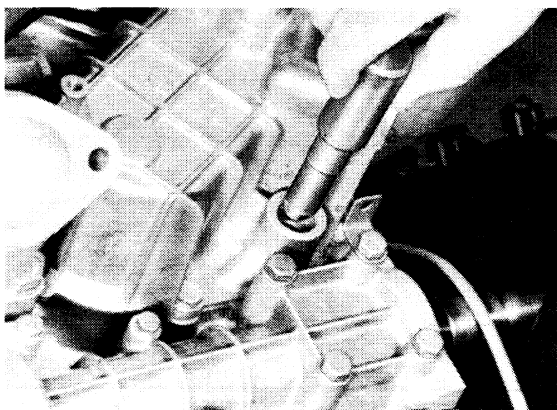

2. Now bolt down centered housing to final torque.
3. Mount oil pressure relief valve.

REMOVING AND INSTALLING PARTS OF
COOLING SYSTEM, '87 MODELS ONWARD

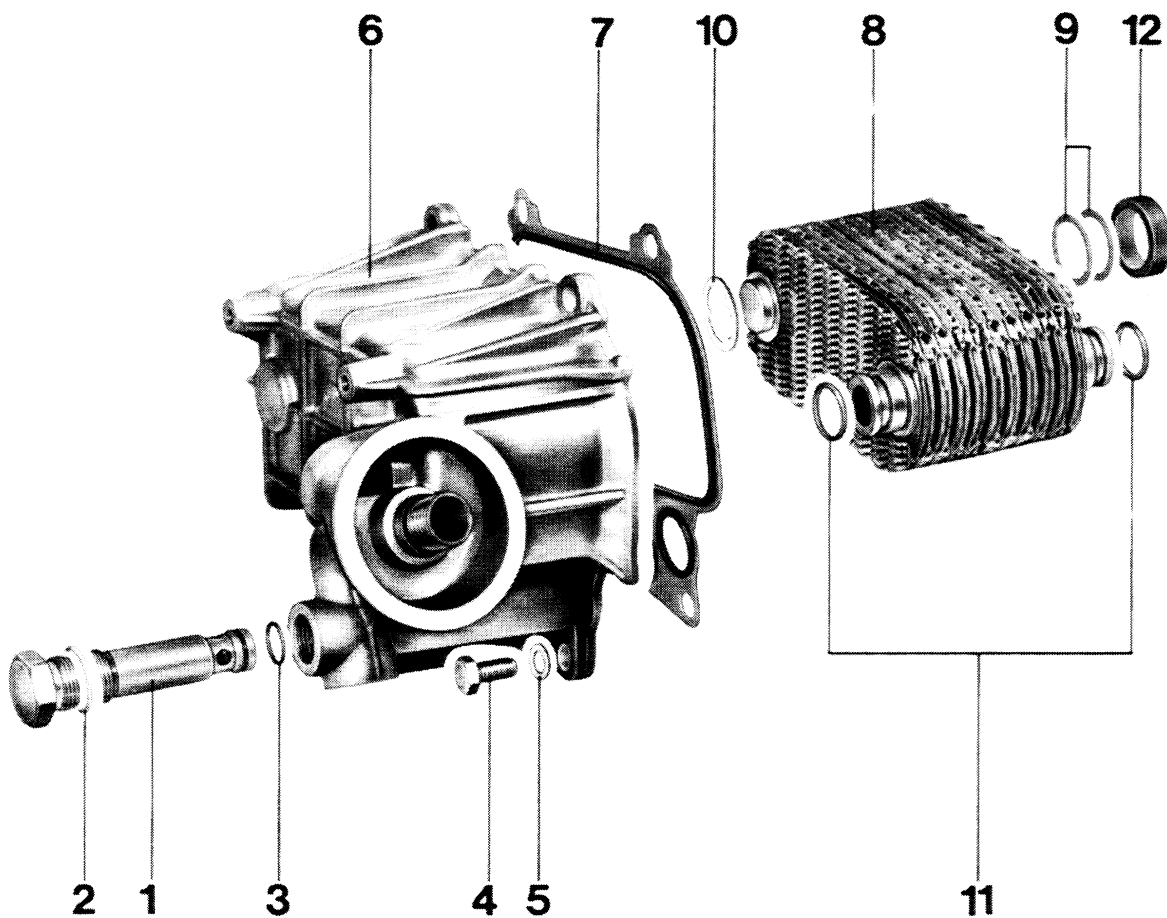

No.	Description	Qty.	Note When:	
			Removing	Installing
1	Oil pressure-relief valve	1		
2	Sealing ring	1		Replace
3	Round-section sealing ring	1		Replace
4	Hex bolt M8 x 25	4		
5	Washer	4		
6	Housing for oil-water heat exchanger	1		
7	Special- section gasket	1		Replace
8	Oil-water heat exchanger	1		Place in housing before assembly
9	Shim (alum- inum, 0.5 mm)	X		
10	Plastic washer	1		Install between housing and oil- water heat exchanger
11	Round-section sealing ring	2		Replace, oil lightly
12	Rubber ring	1		Replace, check that ring is correctly seated in upper crankcase half, install with grease or Curil, for example.

Notes on assembly

A modified oil/water heat exchanger housing has been installed as from Model 87. Part No.: 944 107 149 06. The lower part of the housing's heat-exchanger mounting has been modified. Always use the new housing when overhauling engines in earlier models.

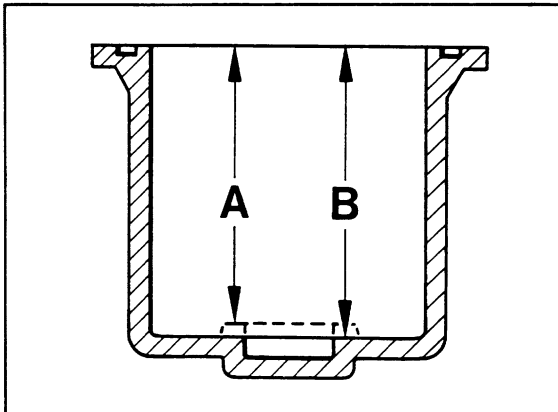

A = Original design

B = New design

Preassembling the heat exchanger

Mount the O-ring-type sealing rings on the oil-feed connector pieces and insert the heat exchanger into the housing with the plastic washer.

2. Lay a straight edge on the contact surface of the housing (without profile-section seal).
3. Make up the gap between the spigot on the heat exchanger and the straight edge with shims (approx. 2). Suitable shims must be fitted to provide an assembly dimension of 0 or ± 0.25 mm.

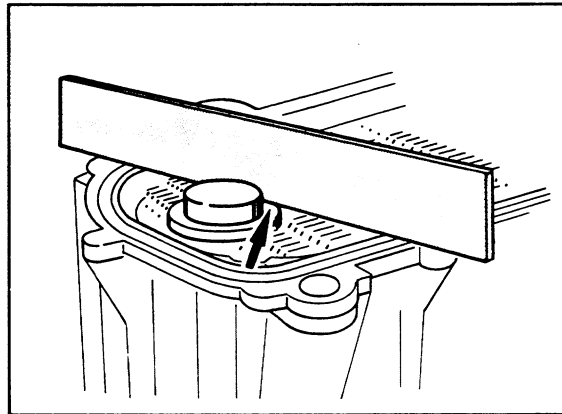

Note

The number of shims required between heat exchanger and crankcase must be redetermined every time repairs are carried out.

4. Position the preassembled housing on the crankcase and tighten the screws lightly. Screw in the lubricated assembly pin 9262/1 by hand, center and tighten the fastening screws (crosswise). If there is any resistance when unscrewing the assembly pin, repeat the assembly procedure.

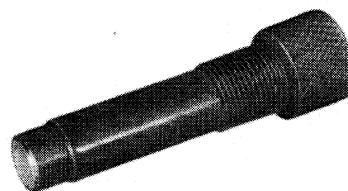

5. Install the oil pressure-relief valve with a new gasket and lubricated O-ring. Tightening torque 45 Nm.

REMOVING AND INSTALLING RADIATOR

Removing

1. Unscrew cap on expansion tank. If engine is hot, first turn cap to first catch and let pressure escape. Then unscrew cap completely.
2. Remove air cleaner complete with air flow sensor.
3. Remove splash guard.
4. Drain and catch coolant through drain plug opening on radiator or coolant hose.

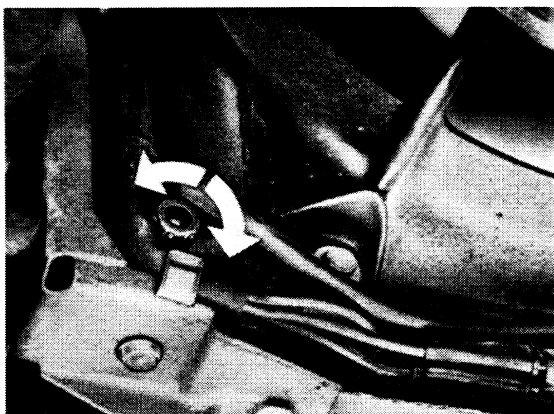

5. Disconnect wire harness on fan housing.

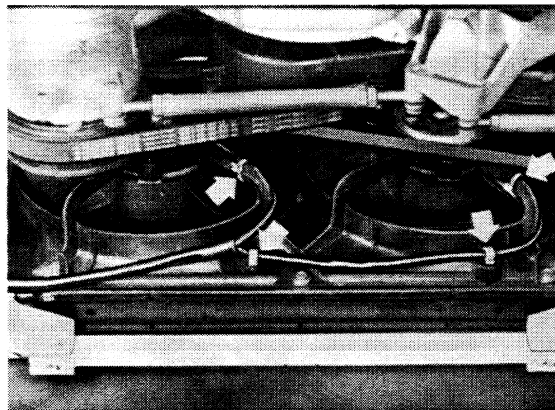

6. Unscrew three each bolts on top and bottom and remove complete fan housing.
7. Disconnect coolant hoses.
8. Cars with automatic transmission:
Disconnect ATF hoses on radiator while holding.

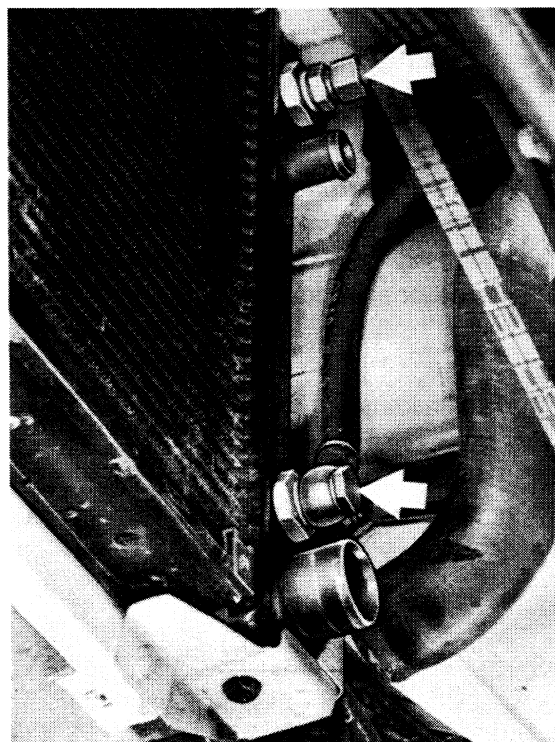

9. Loosen two straps on coolant feed hose and two clamps.

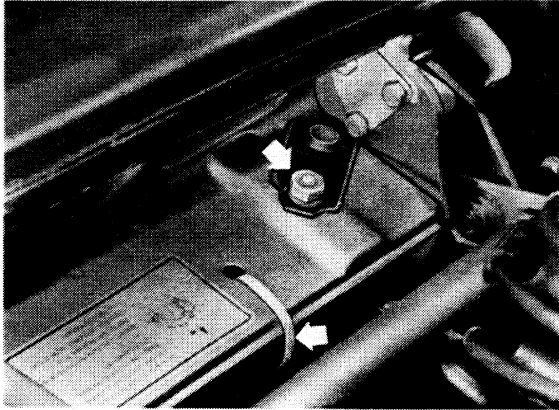

10. Disconnect vent hose, tilting radiator back slightly for this purpose.

11. Remove radiator from below.

Installing

1. Check that radiator fits properly in rubber mounts.
Place radiator on bottom rubber mounts first and then press in forward direction, making sure that rubber seal between top of radiator and lock carrier is not damaged.
2. Install clamps and straps.
3. Pour in coolant and bleed cooling system (see page 19 - 1).

REMOVING AND INSTALLING TEMPERATURE SWITCH

Removing

1. Remove air cleaner complete with air flow sensor.
2. Remove splash guard.
3. Remove fan housing.
4. Drain approx. 2 liters of coolant.
5. Unscrew temperature switch (wrench size across flats: 30 mm).

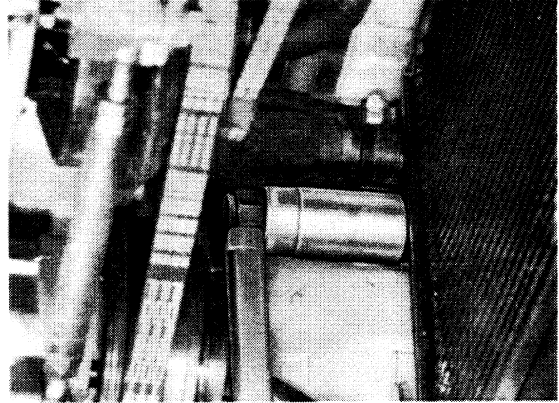
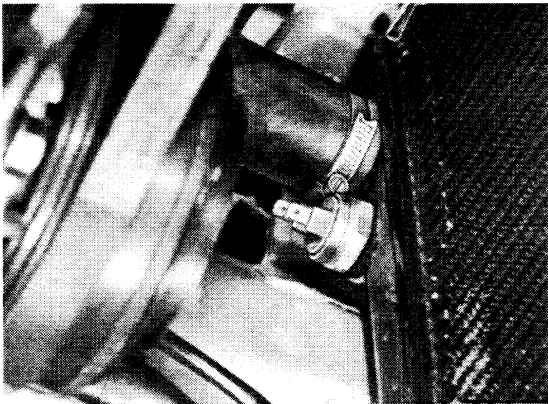

Installing

Torques:

- with plastic thread: 20 Nm
 - with brass thread: 28 Nm
- each in conjunction with a new fiber seal ring, Part No. 900.123.012.70

CHECKING TEMPERATURE SWITCH

1. Remove temperature switch.

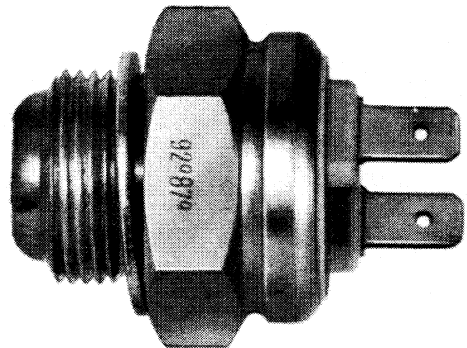

2. Connect testing buzzer on flat male plugs of switch. Place switch in warm water bath.

Buzzer must sound off at temperature of about 92°C and stop buzzing when temperature drops to approx. 87°C.

Cleaning the cooling system after water has been contaminated with oil

Cleaning

1. Drain the coolant (drain plugs on cooler and crankcase). There is no drain plug in the crankcase as from Model 89. Drainage facility from the plastic auxiliary connection piece of the water pump.

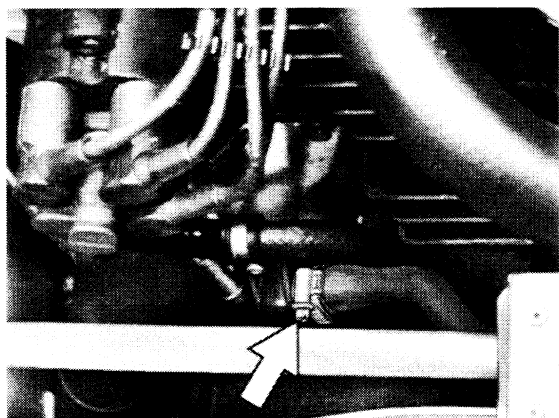

88/150

2. Remove the water expansion tank and clean separately with cold cleaning agent.
3. Pour 2 liters of cold cleaning agent into the coolant system. Fill up with water (approx. 6 liters).
4. Allow the engine to warm up and bleed.
5. Once the thermostat has opened, run the engine at a higher speed for approx. 2 minutes with the heating turned on.
6. Shut down the engine, drain off all cleaning fluid.

7. Fill the cooling system with new cold cleaning agent and fresh, warm water and clean again.

Rinsing

Then rinse out with clear, warm water. Repeat the rinsing procedure until there is no evidence of oil or cold cleaning agent in the water.

Filling the cooling system

1. Fill the cooling system with warm water and antifreeze.
2. Bleed the cooling system, see Page 19 - 2.

REPLACING FUEL FILTER

1. Pinch fuel feed line shut with a standard hose clamp. Unscrew fuel lines, not forgetting to counterhold. Catch escaping fuel.
2. Loosen clamp and remove fuel filter.

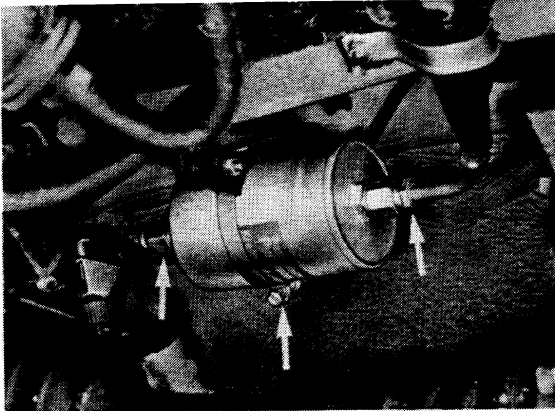

3. Install new filter. Watch direction of flow = direction of arrow.
4. Remove hose clamp. Start engine and check fuel lines as well as fuel filter for leaks.

CHECKING FUEL AND INJECTION LINES FOR LEAKS AND TIGHTNESS

1. Inspect visually for leaks.
2. Tighten coupling nuts and hose clamps.

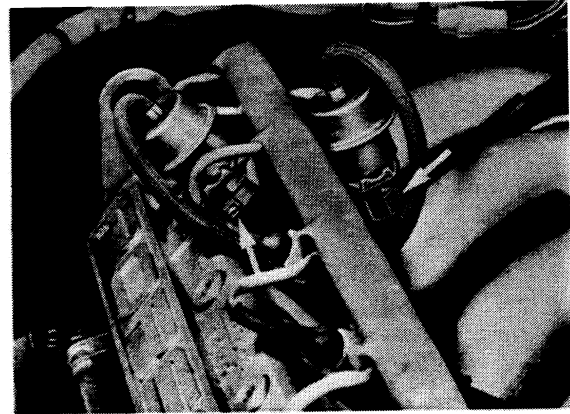

CHECKING FUEL PUMP DELIVERY RATE

Requirements:

Fuel filter and power supply in perfect condition.

1. Unscrew fuel return hose on pressure regulator. Catch escaping fuel.

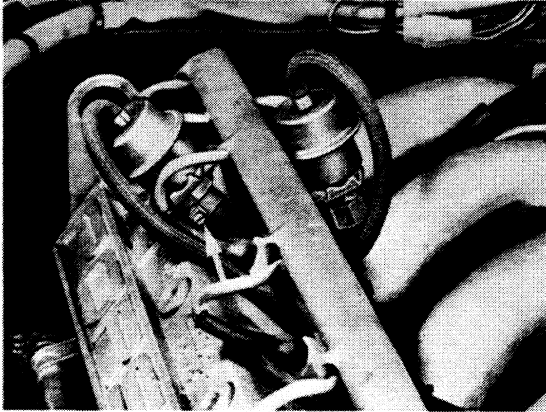

2. Connect standard hose and hold other end in a measuring glass (approx. 1500 cm³ volume).

3. Pull off fuel pump relay on fuse/relay board.

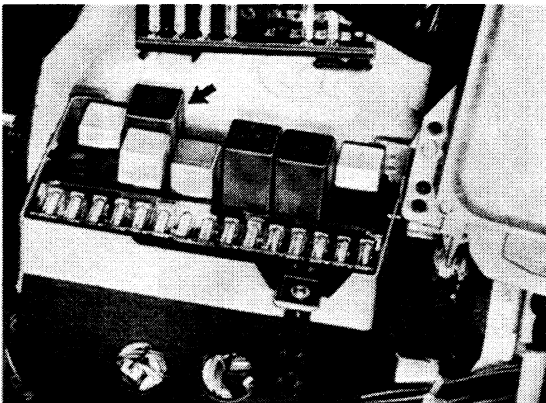

4. Bridge terminals 30 and 87 b with a piece of wire. Fuel pump should now run.

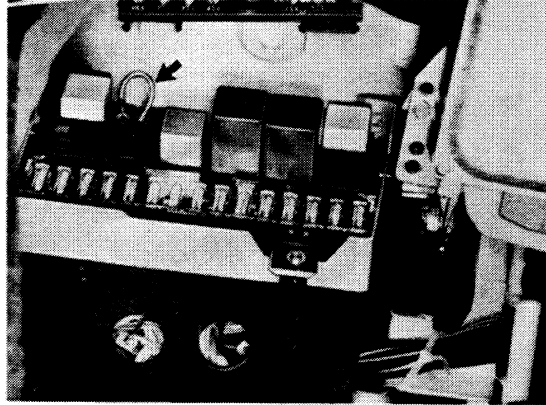

Note:

Fuel pump can also be run by supplying battery voltage to terminal 4 (black/green) of multiple-pin plug with a piece of wire.

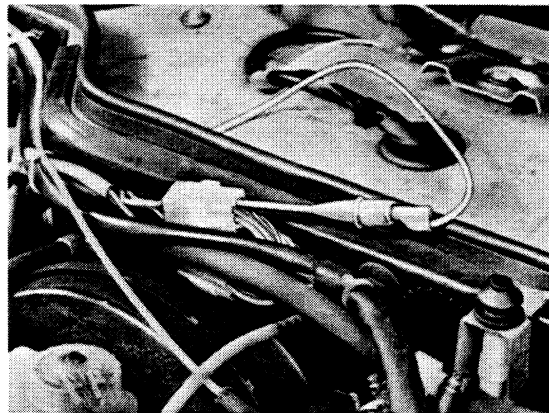

5. Let fuel run into measuring glass 30 seconds. See page 25 - 3 for test values.

REMOVING AND INSTALLING FUEL PUMP

Note

Conform with local safety regulations for working on fuel systems.

Removing

1. Disconnect battery ground lead.
2. Take off fuel pump cover at bottom right. Pinch fuel feed hose with a standard hose clamp, loosen hose clamp and pull hose off of fuel pump. Disconnect electric plug.

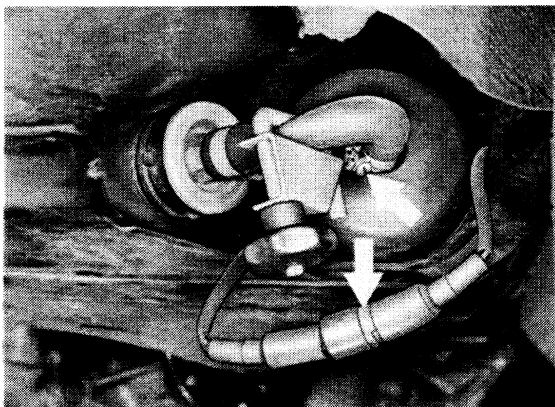
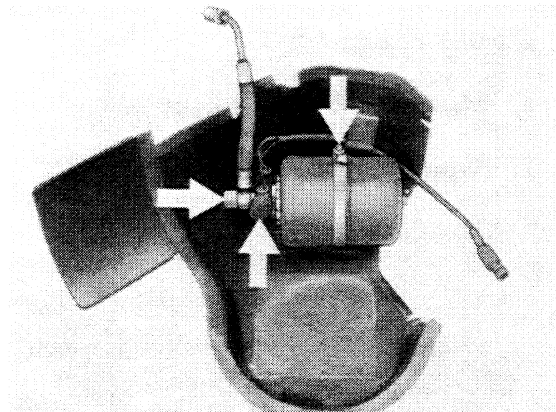

Installing

1. Always use new seals.
 2. Tightening torque for capped nut is 22 Nm, while counterholding.
 3. Remove hose pinching clamp and check for leaks. Install guard again.
-
-
3. Unscrew fuel pipe from pump on fuel filter, while counterholding with a second wrench. Catch escaping residual fuel.
 4. Loosen right fuel tank strap at bottom and detach. Take off lower guard with fuel pump.
 5. Unscrew and remove fuel pipe and electric connector on pump. Loosen hose clamp and remove fuel pump.

REMOVING AND INSTALLING FUEL TANK

Removing

1. Disconnect battery ground lead.
2. Draw out fuel.

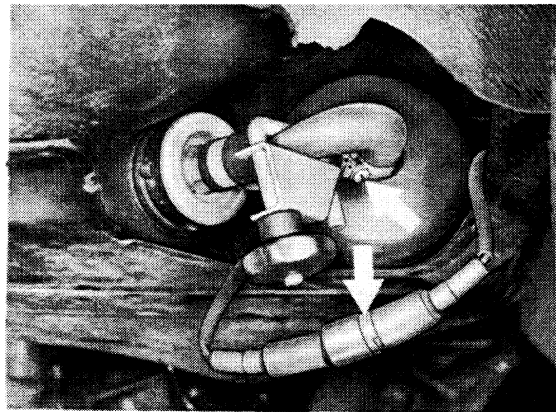
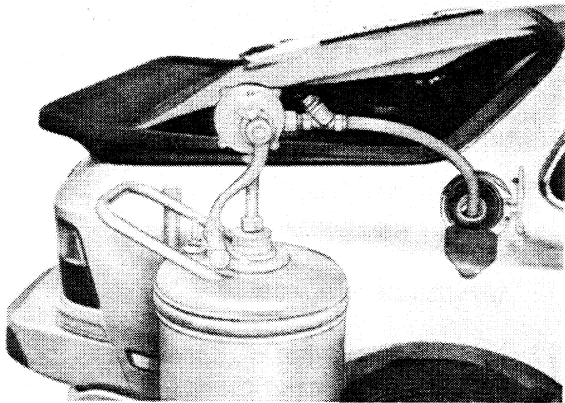

Note

Conform with local safety regulations for working on fuel systems.

3. Unscrew hexagon head bolts on exhaust flange and both final muffler suspension points, and take off assembly.
4. Unscrew final muffler shield on fuel tank and rear suspension point, and remove.
5. Take off fuel pump cover at bottom right. Pinch fuel feed hose with a standard hose pinching clamp, loosen hose clamp and pull hose off of fuel pump. Disconnect electric plug.

6. Unscrew fuel pipe from pump on fuel filter, while counterholding with a second wrench. Catch escaping residual fuel.
7. Unscrew right strap of fuel tank at bottom and detach. Remove lower guard with fuel pump.
8. Remove transmission — see Group 34 in Repair Manual.
9. Unscrew fuel pipe on fuel filter, while counterholding with a second wrench. Unscrew transmission carrier on body and take off with the fuel filter.

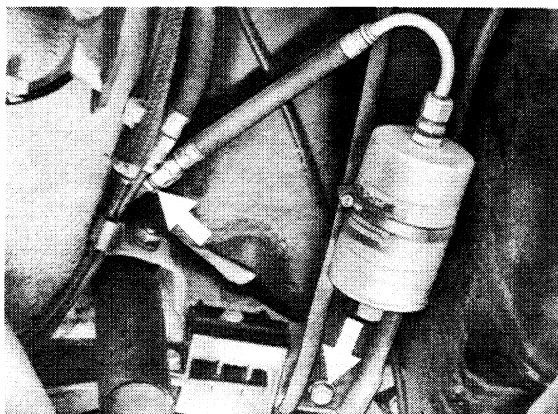

10. Remove trunk floor cover. Take off cover for fuel level transmitter. Pull off fuel return hose and electric plug on level transmitter.

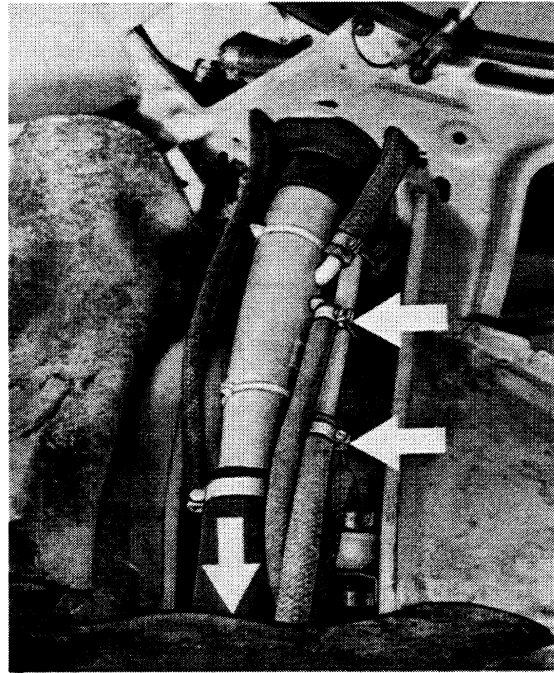
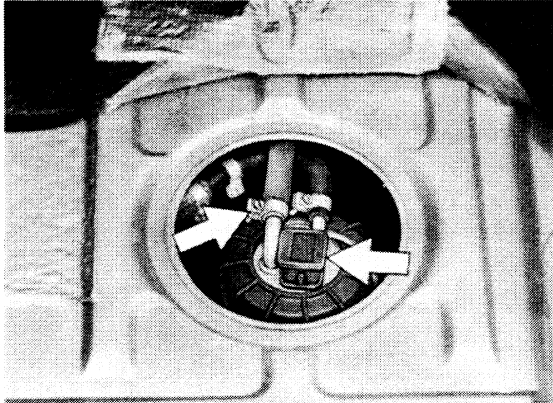

11. Remove right rear side window. Loosen and take off side trim panel carefully. Pull off wheel house trim and insulation sheet up to rear cover of fuel filler neck. Loosen and remove cover.
12. Loosen hose clamp on fuel filler neck. Pull off both fuel vent hoses on filler neck.

13. Loosen left strap of fuel tank at bottom and unscrew both M 8 nuts, and remove.

14. Remove fuel tank by pulling back and down.

Installing

1. Make sure of perfect hose connections and hose routing prior to installation of the fuel tank.

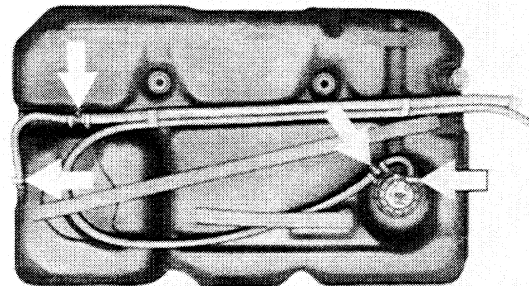

2. Insert both inner sealing hoses (with bead) into connecting hose. Coat inner sealing hoses with assembly oil, e.g. Capella WE32 or Omnis 32. If necessary, Contifix tire mounting paste can also be used.

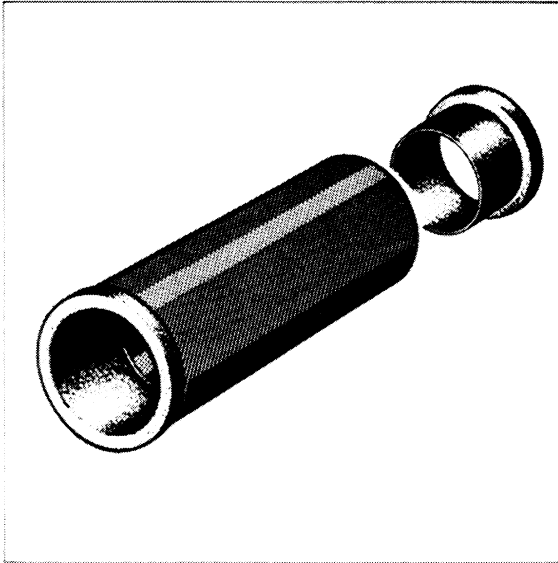

3. Slide preassembled connecting hose onto tank neck or filler neck, paying attention to correct seating of inner sealing hoses (avoiding creases).
4. Seal cover for filler neck thoroughly with a sealing compound (8) prior to installation to prevent leakage of fuel vapors.

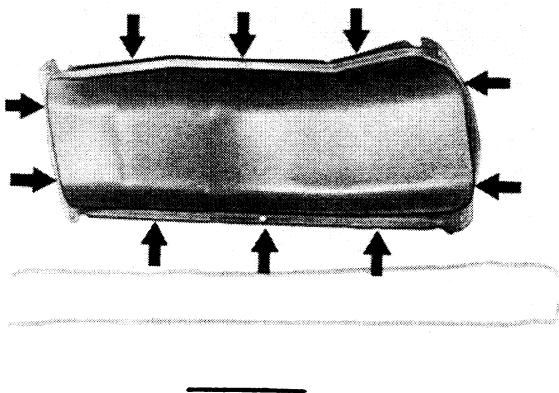

FUEL SYSTEM LINE ROUTING – 1985/2 MODELS

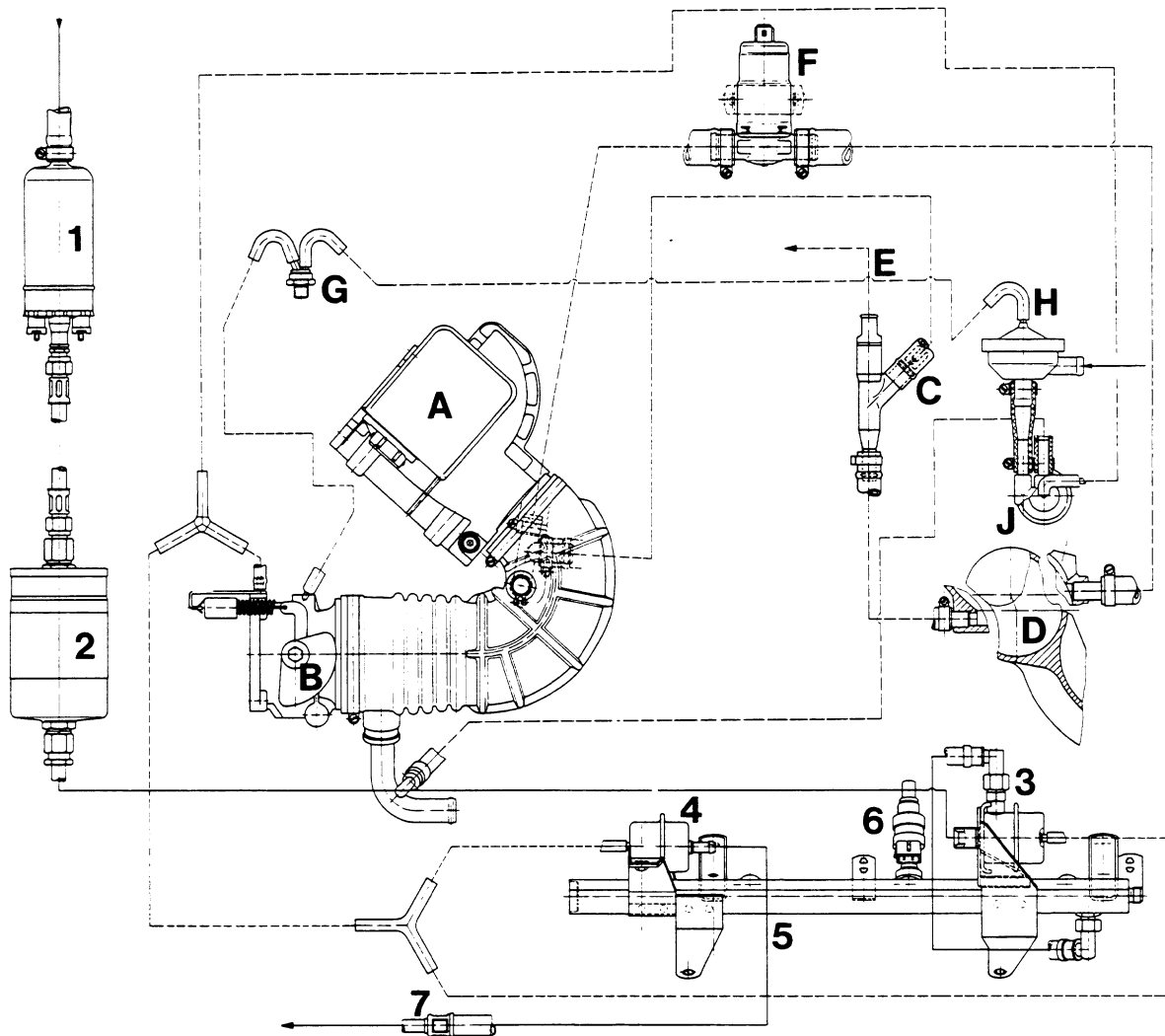

- 1 - Fuel pump
- 2 - Fuel filter
- 3 - Pressure damper
- 4 - Pressure regulator
- 5 - Injection line
- 6 - Fuel injector
- 7 - Fuel return

- A - Air flow sensor
- B - Throttle housing
- C - Ejection pump
- D - Intake pipe
- E - To brake booster
- F - Idle speed control
- G - Temperature valve
(open above 58° C)
- H - Shutoff valve
- J - Control valve

ACTIVE CARBON TANK FOR POLLUTANT-FREE FUEL TANK VENTING
(LAYOUT)

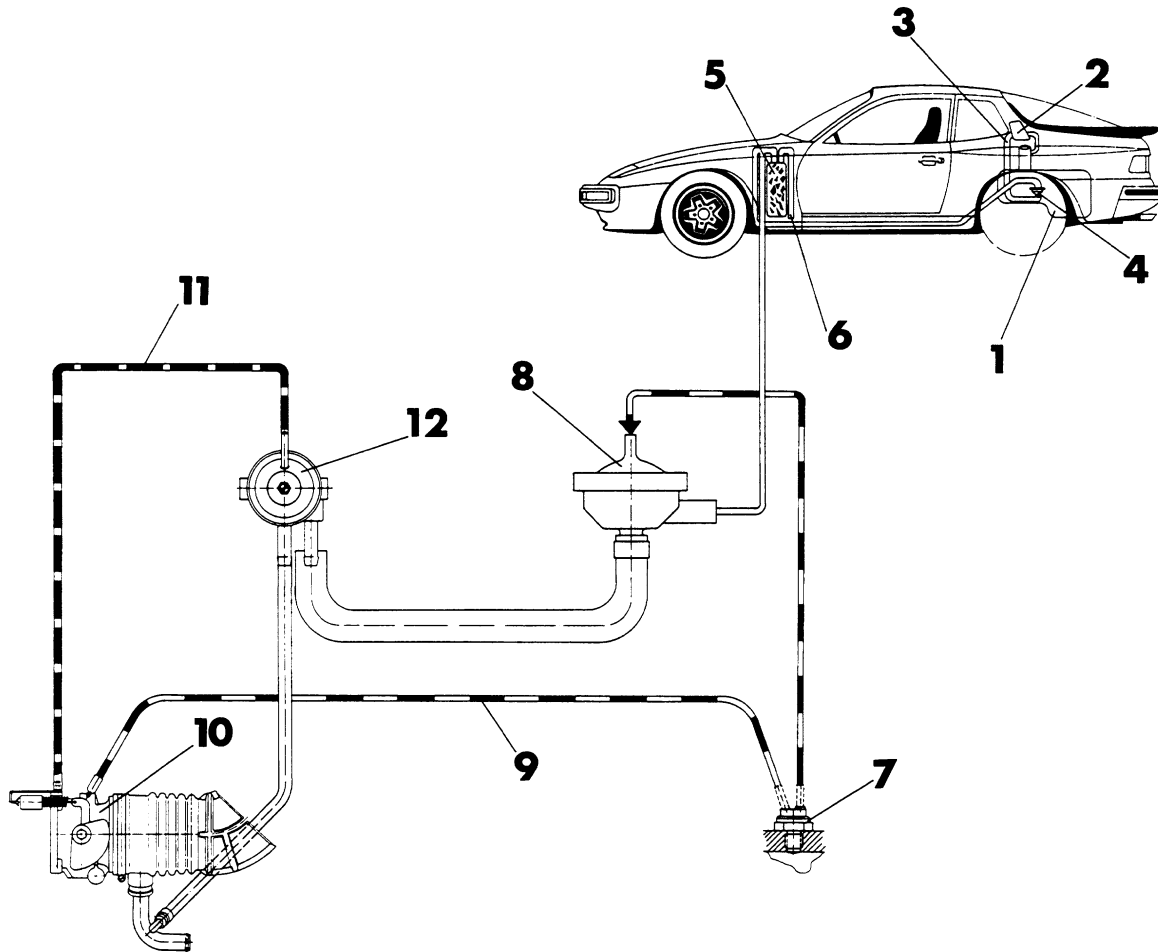

- | | |
|------------------------|-----------------------|
| 1 - Fuel tank | 7 - Temperature valve |
| 2 - Expansion tank | 8 - Shutoff valve |
| 3 - Vent line | 9 - Vacuum line |
| 4 - Safety valve | 10 - Throttle valve |
| 5 - Active carbon tank | 11 - Vacuum line |
| 6 - Flushing air line | 12 - Control valve |

REMOVING AND INSTALLING FUEL EXPANSION TANK (Since July, 1983)**Note**

Conform with local safety regulations for working on fuel systems.

Removing

1. Disconnect battery ground lead.
2. Remove right rear side window.
3. Loosen and take off side trim panel carefully.
4. Pull off wheel house trim and insulation sheet up to rear cover on filler neck. Loosen and take off cover.
5. Remove guard for expansion tank.
6. Loosen both hose clamps on expansion tank and pull off hoses. Unscrew expansion tank mounting bolt.

Installing

1. Check for perfect seating of hoses and hose clamps.
2. Seal cover for fuel filler neck thoroughly with a sealing compound (tape) prior to installation, to prevent leakage of fuel vapors.

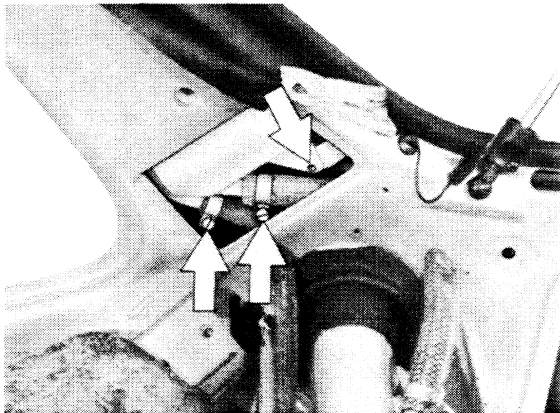

7. Pull out expansion tank from below.

CHECKING FUEL EXPANSION TANK

1. Check fuel expansion tank after removal.
2. Plug venting connection.
3. Connect manual vacuum pump 9160 on drawing-off connection.

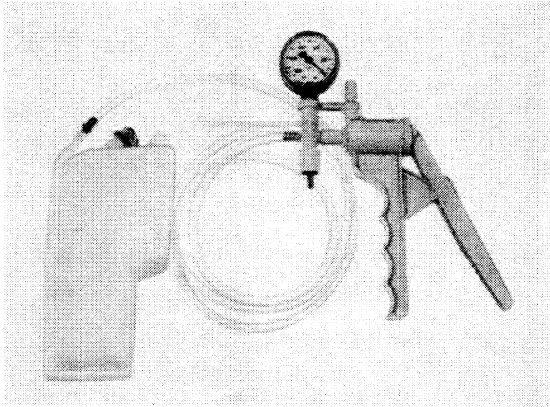

4. The pressure gage reading should not drop with sufficient vacuum (approx. 400 mbar).

REMOVING AND INSTALLING FUEL
LEVEL SENDER

TOOLS

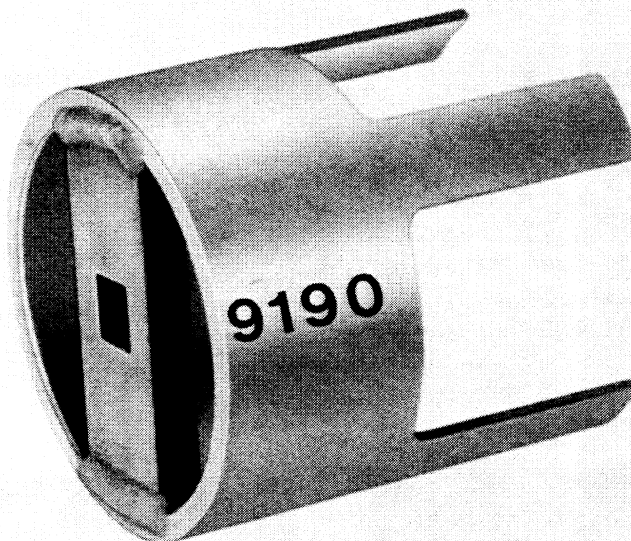

No.	Description	Special Tool	Remarks
	Pin wrench	9190	

REMOVING AND INSTALLING FUEL LEVEL SENDER

Note:

Observe safety precautions for working on the fuel system. Do not remove sender when tank is full.

Removing

1. Remove luggage-compartment floor covering. Remove panel covering fuel-level sender. Slacken hose clamps. Disconnect fuel return hose, breather hose and electrical connections from sender.

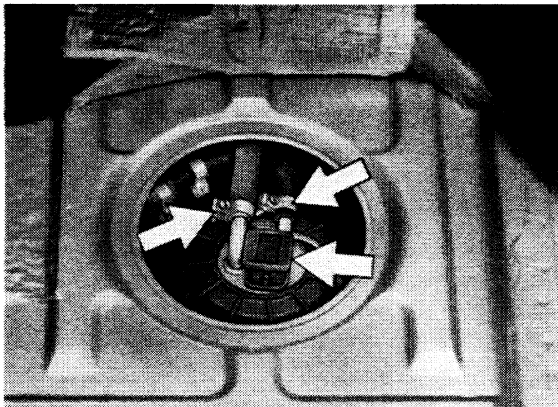

2. Slacken union nut with Special Tool 9190. Remove sender with seal.

Installing

1. Always use a new seal. Coat thread and contact face of union nut with Optimoly TA.
2. Tighten union nut with Special Tool 9190 to specified torque.

Note

To facilitate assembly, immerse the new union nut in a container with water heated to 60 to 70 deg. C for approx. 8 minutes

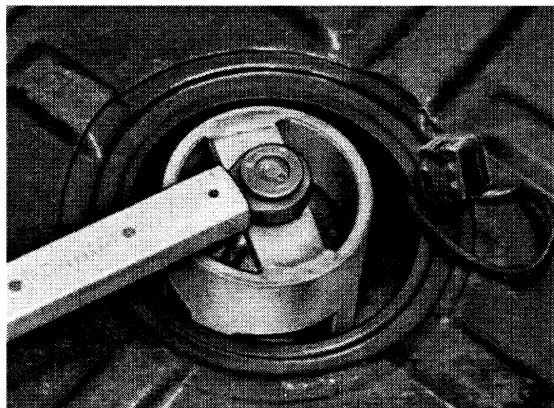

3. Tightening torque for union nut 35 ± 5 Nm (26 ± 3.6 ftlb).
4. When reconnecting the fuel return hose, ensure that the screw of the hose clamp does not come into contact with union nut or fuel-level sender.

REPLACING AIR FILTER CARTRIDGE

1. Loosen, vent hose and mounting screws with a screwdriver and remove housing cover.

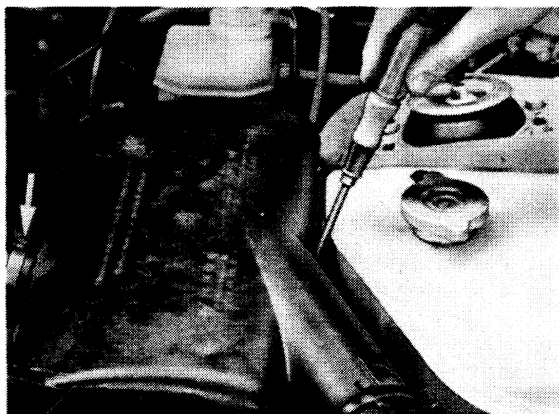

2. Remove filter cartridge and clean inside of air cleaner housing lower section with a lint-free cloth.
3. Install filter cartridge, mount housing cover carefully and tighten mounting screws. Make sure dust cover fits correctly between air cleaner inlet and wheel house side wall.

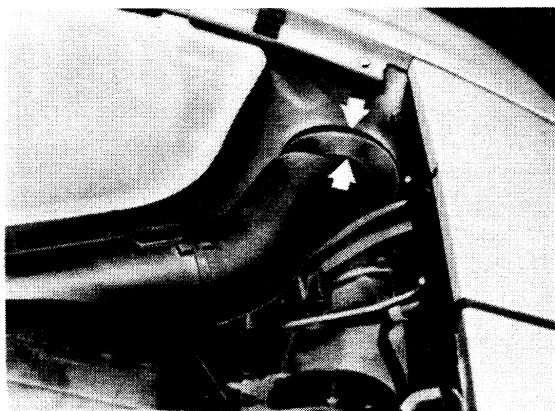

CHECKING INTAKE AIR GUIDE AND CRANK-CASE VENT HOSES FOR LEAKS AND TIGHT FIT

1. Check all hoses of intake system for correct fit.
2. Tighten hose clamps.

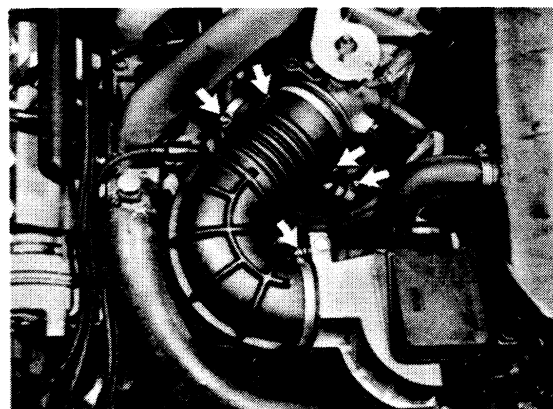

REPLACING AIR FILTER CARTRIDGE

1. Loosen, vent hose and mounting screws with a screwdriver and remove housing cover.

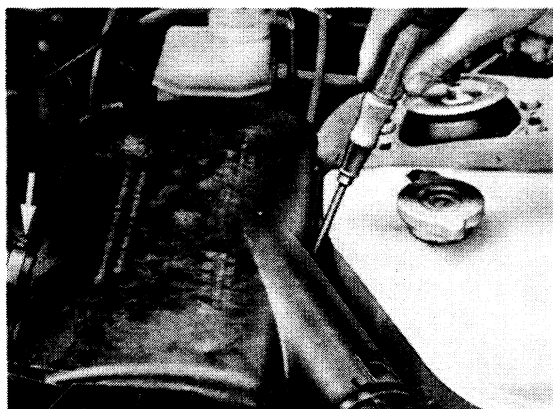

2. Remove filter cartridge and clean inside of air cleaner housing lower section with a lint-free cloth.
3. Install filter cartridge, mount housing cover carefully and tighten mounting screws. Make sure dust cover fits correctly between air cleaner inlet and wheel house side wall.

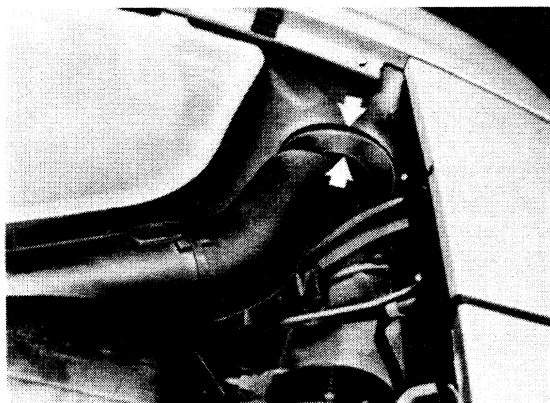

CHECKING INTAKE AIR GUIDE AND CRANK-CASE VENT HOSES FOR LEAKS AND TIGHT FIT

1. Check all hoses of intake system for correct fit.
2. Tighten hose clamps.

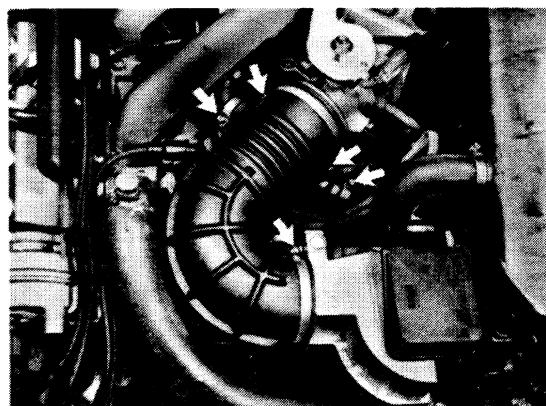

TESTING AND ADJUSTING SPECIFICATIONS

Test	Specification	Remarks
Electric fuel pump Delivery rate	at least 850 cc/30 sec.	
Fuel pressure (engine stopped) Fuel pump bridged Idle speed value	2.5 ± 0.2 bar approx. 2 bar	
Leak test Min. pressure after 20 minutes	1 bar	
Idle adjustment Idle speed (rpm) Europe USA/Canada/Japan Australia + Sweden CO (%) Europe USA/Canada/Japan Australia + Sweden	 800 + 50 900 ± 50 800 + 50 0.5 – 1.0 0.6 ± 0.2 * 0.5 – 1.0	Idle speed: Adjust to top limit for cars with auto- matic transmission or power steering. * Measured ahead of catalytic con- verter and with oxygen sensor plug disconnected

TESTING AND ADJUSTING SPECIFICATIONS
MODELS FROM 85/2 AND 924 S

Test	Specification		Remarks
Electric fuel pump Delivery rate	min. 850 cm ³ /30 sec 750 cm ³ /30 sec **		
Fuel pressure (Engine stopped) Fuel pump bridged	2.5 ± 0.2 bar		
Idle speed control value	approx. 2 bar		
Leak test min. pressure after 20 Min.	1 bar		
Idle adjustment	without catalytic converter	USA and catalytic converter vehicles	
Idle Speed 1/min	840 ± 20	840 ± 20	
CO-Content	0.5 - 1.5	0.6 ± 0.2*	*Measured ahead of catalytic converter and with Lambda sensor plug disconnected

* USA and catalytic converter cars

** Speed-reduced pump with green paint color code,
Bosch No. 0 580 464 028

CHECKING FUEL PRESSURE

TOOLS

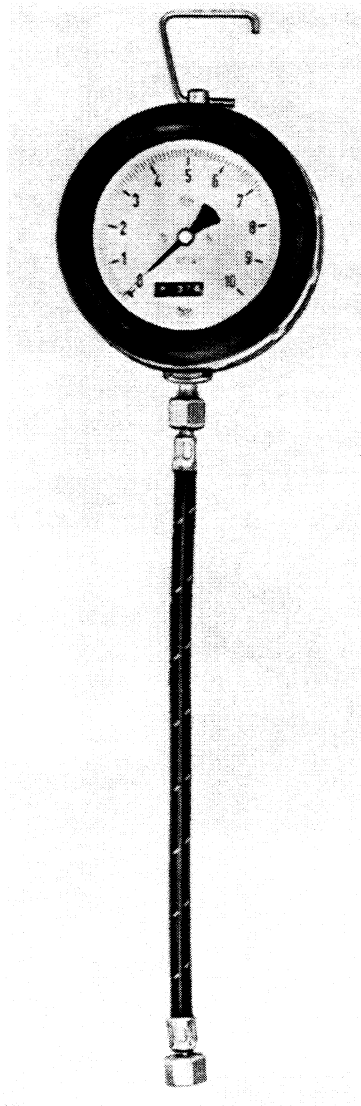

No.	Description	Special Tool	Remarks
	Pressure gage with hose from pressure tester	P 378	or VW 1318

CHECKING FUEL PRESSURE

1. Unlock and fold up cover. Unscrew and remove capped nut on test connection of fuel distribution line.

Note

Be careful that sealing ball does not fall out when removing the capped nut.

2. Connect pressure gage on test connection with hose from pressure tester P 378 or VW 1318.

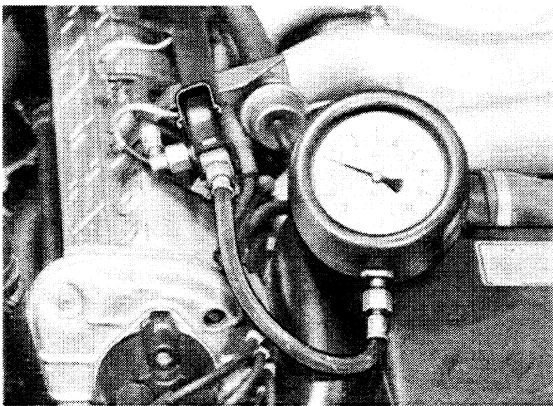

3. Pull off fuel pump relay on central electric board.

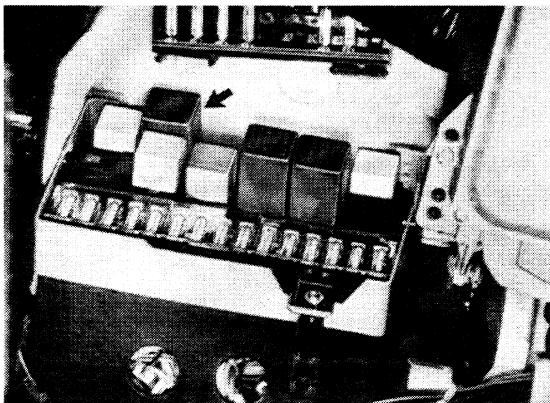

4. Bridge terminals 30 and 87b with a piece of wire. Fuel pump must now run.

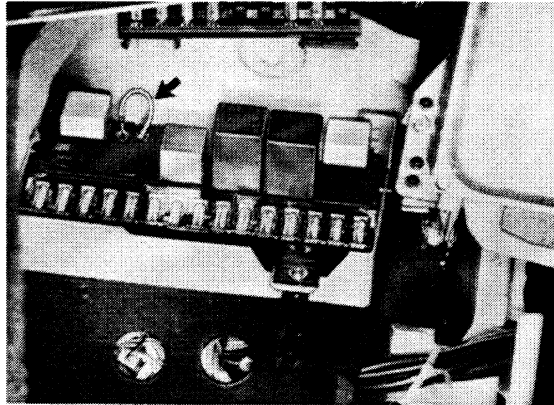

Bridge fuel pump relay in central electric board at left front in blower/fresh air chamber from 1985/2 models on.



5. Control values:
Engine stopped = 2.3 to 2.7 bar (relay bridged)
Engine running at idle speed = approx. 2 bar.
6. Tightening torque of capped nut = 22 Nm.

MAKING IDLE ADJUSTMENTS – USA

TOOLS

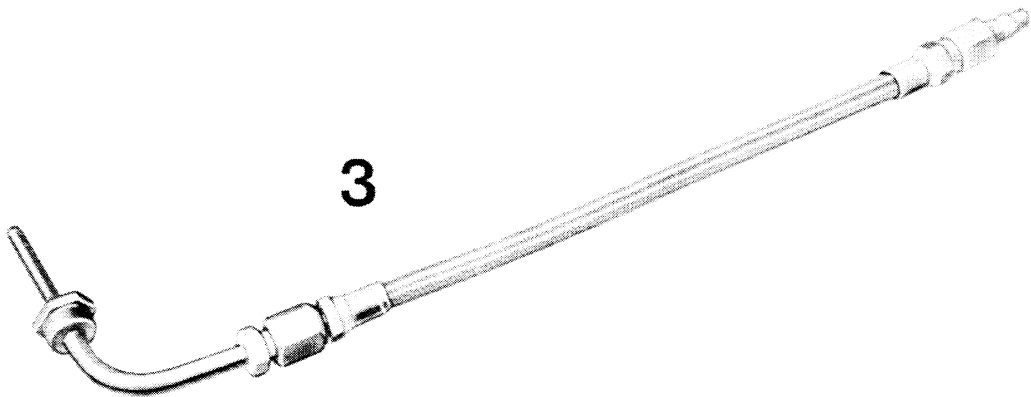
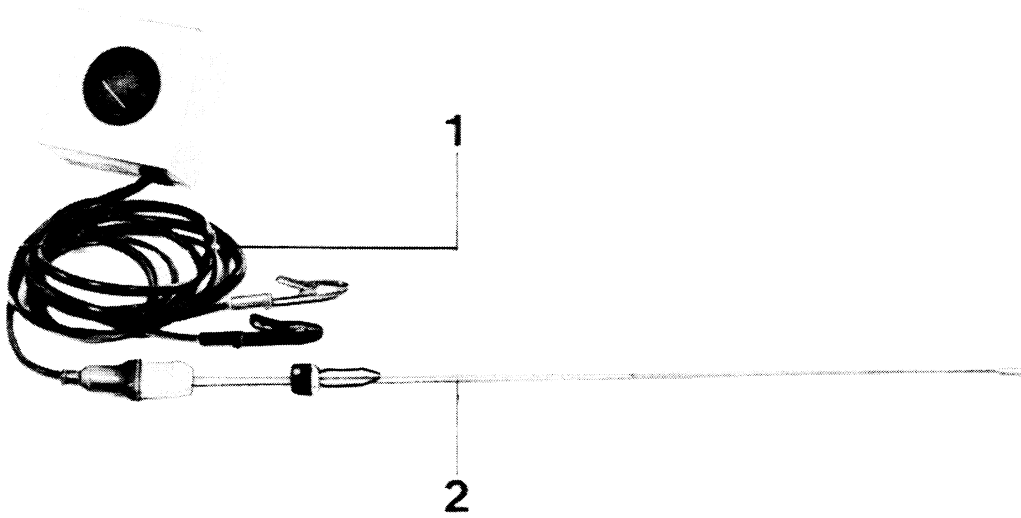

No.	Description	Special Tool	Remarks
1	Oil temperature tester	9122	
2	Testing sensor	9122/1	
3	Exhaust gas test line	US 8023	or SUN 120 – 239

ADJUSTING IDLE SPEED/CO – USA

Note

Adjusting Requirements:
Engine must be in perfect running condition.

1. Connect exhaust gas test line US 8023 or SUN 120 – 239 on test connection of catalytic converter.

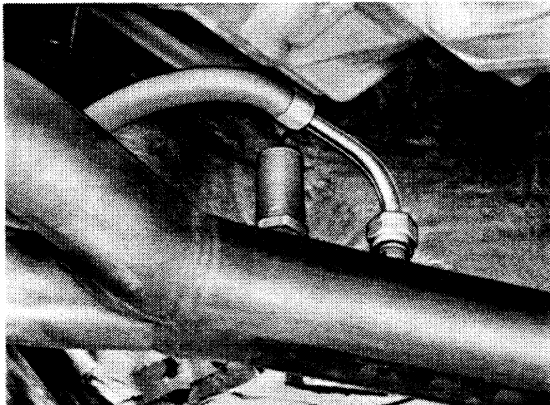
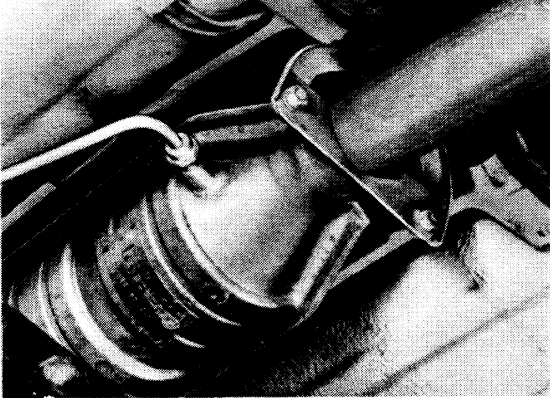

Since 1984 Models

2. Connect CO tester according to manufacturer's instructions.

3. Connect oil temperature tester 9122. Adjust test sensor to length of oil dipstick.

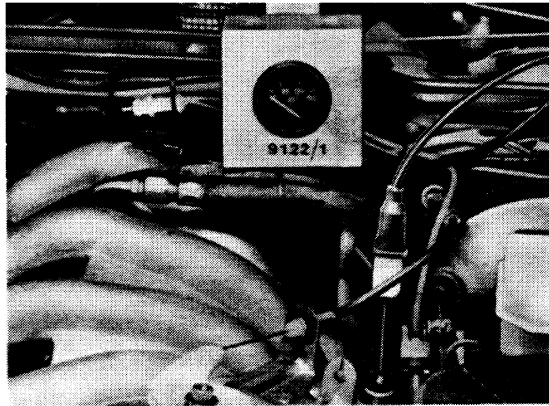

4. Run engine to operating temperature (oil temperature approx. 80° C/176° F).
5. Turn regulating screw or bypass screw on throttle housing until specified speed is reached. Use separate tachometer from tester or similar.

Note

Fan motor and a/c compressor must be switched off during adjustments.
Make adjustments as quickly as possible to prevent intake ports from becoming too hot, to avoid false CO reading.

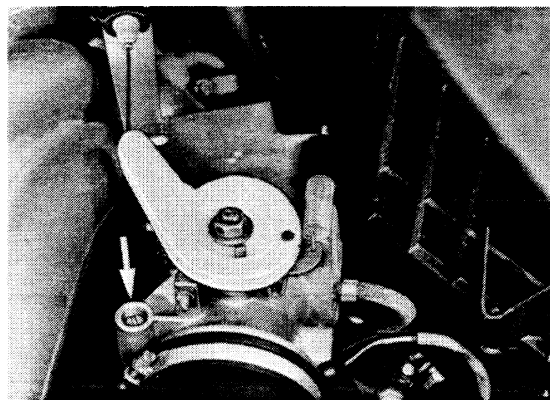

6. Pull off rubber cap on plug for oxygen sensor and detach plug.

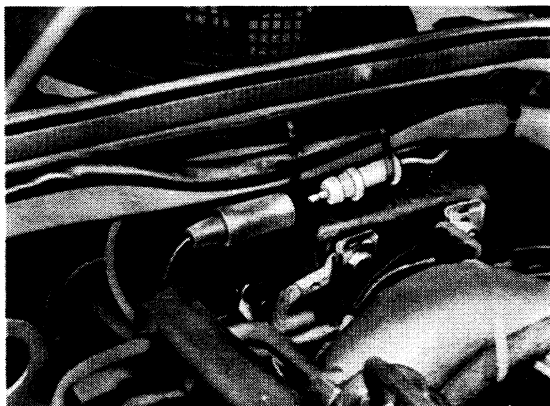

7. Check CO level. If CO level is not the specified value, correct the setting on the air flow sensor.

8. Connect plug for oxygen sensor again after finishing adjustments.

9. Coat threads of cap nut for test connection on catalytic converter with Bosch VS 140 16 Ft or Optimoly HT grease.
Torque specification: 30 Nm (22 ft lb).

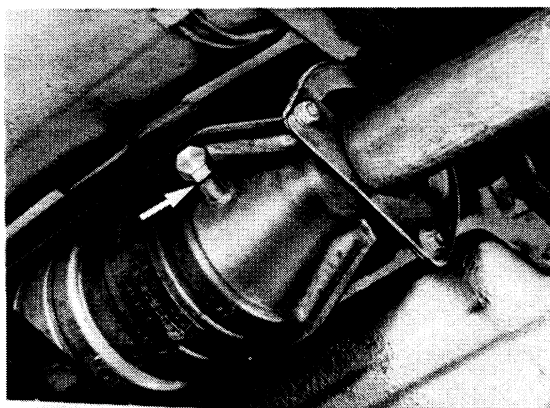

CORRECTING CO SETTING ON AIR FLOW SENSOR - USA

Note

If CO level is not as specified, remove plug from bore providing access to the mixture regulating screw after removing the air flow sensor.

3. Install a new plug in bore providing access to mixture regulating screw after finishing adjustments. Press plug in flush.

Removing

1. Remove air flow sensor.
2. Drill hole in plug with a 2 mm dia. drill (against steel insert).
3. Pull out plug with a left-hand twist drill (No. 2).

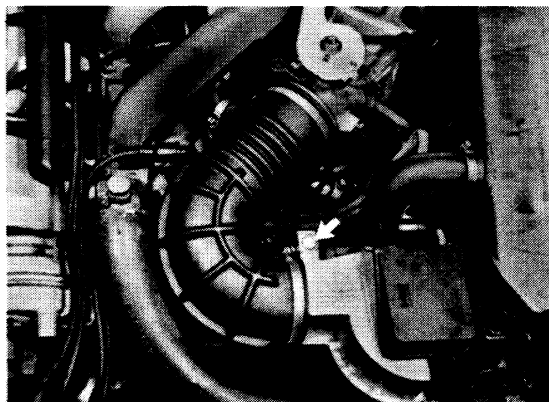

Installing

1. Install air flow sensor.
2. Adjust idle speed and correct CO level.
Turn mixture regulating screw accordingly with a screwdriver.
Turning clockwise = richer mixture

Note

Never reuse drilled plugs!

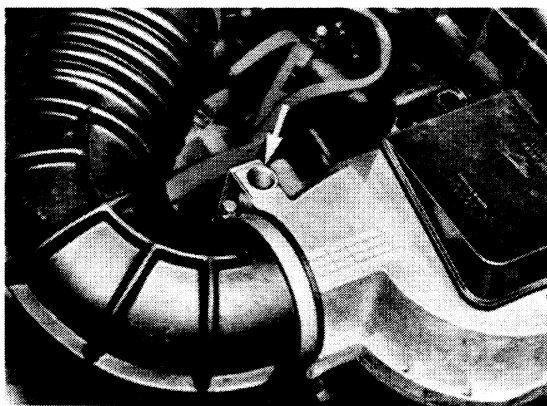

REMOVING AND INSTALLING FUEL INJECTORS

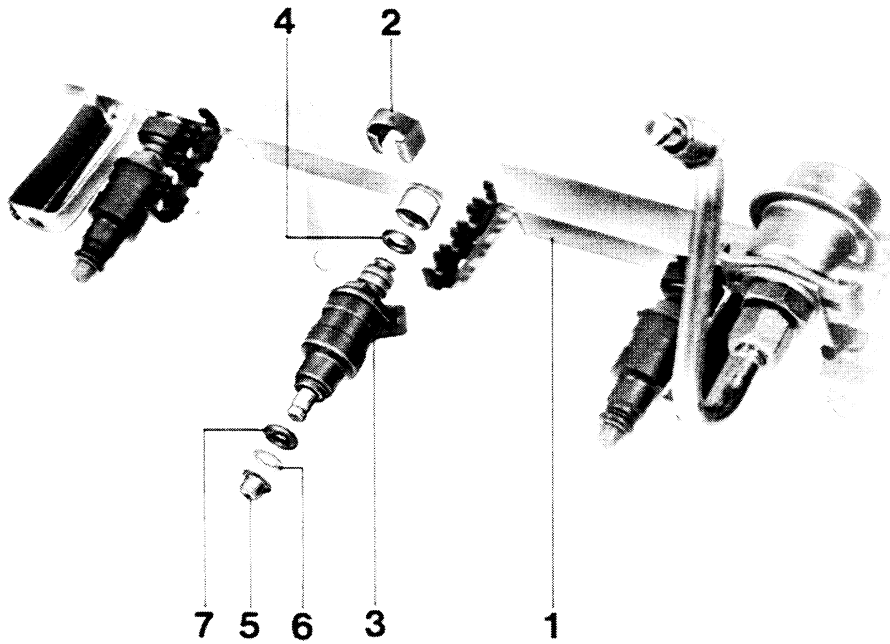

No.	Description	Qty.	Note When		Special Instructions
			Removing	Installing	
1	Fuel distribution tube	4			
2	Retaining clamp	4		Check for correct fit in groove	
3	Fuel injector	4		Electric connection faces down	
4	Seal	4		Replace	
5	Protective sleeve	4		Replace, press on and be careful not to damage injector needle	
6	Seal	4		Replace	
7	Washer	4			

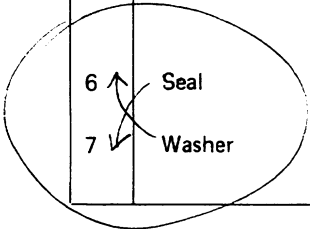

INSTALLING FUEL INJECTORS

1. Coat bottom seal with a silicone grease,
e. g. Bosch Ft 2 v 2 and press fuel injectors
into bores of intake manifold separately.

 2. Then push fuel distributor pipe on fuel
injectors and mount retaining clamps.
- _____

Removing and Installing Air Flow Sensor

Removing

1. Loosen hose clamp on intake air cowl, disconnect plug on air flow sensor, unscrew phillips head screws on upper air cleaner section and take out air filter cartridge.

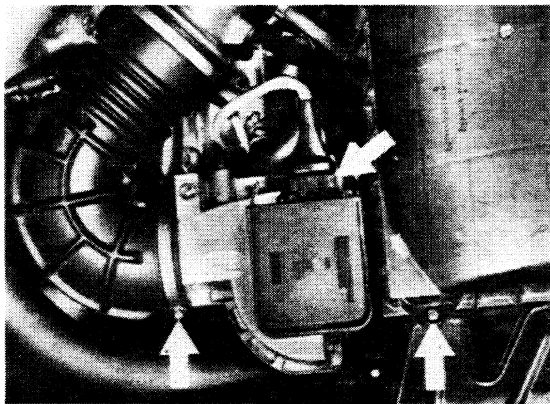

7885

2. Unscrew mounting screws between lower air cleaner section and air flow sensor, heating the screw head zone to about 150° C (300° F) with a hot air blower if necessary. Never aim the hot air stream at the air flap potentiometer.

Installing

Clean threads, coat lightly with Loctite No. 270 and tighten screws with 10 Nm (7 ft. lbs.) torque.

REMOVING AND INSTALLING FUEL INJECTORS

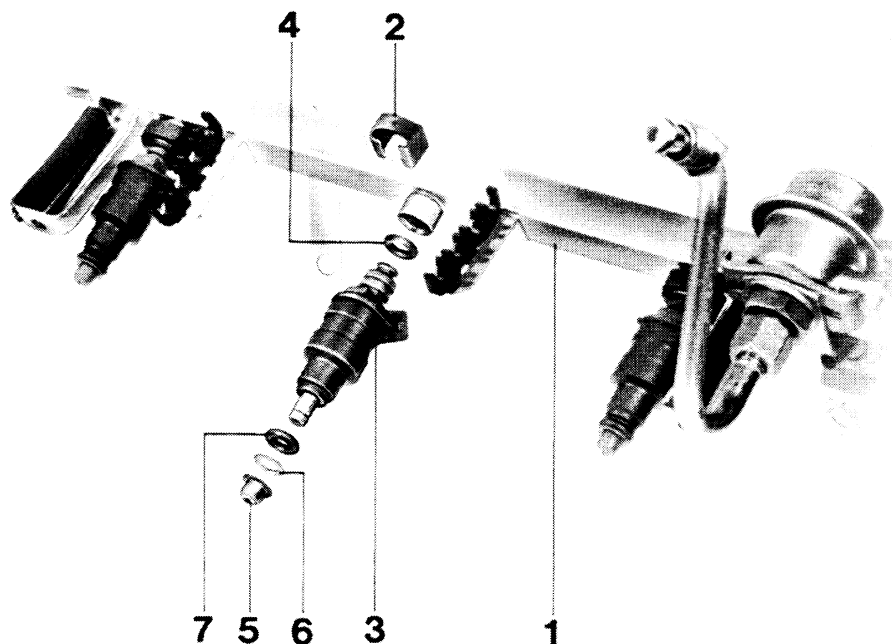

No.	Description	Qty.	Note When		Special Instructions
			Removing	Installing	
1	Fuel distribution tube	4			
2	Retaining clamp	4		Check for correct fit in groove	
3	Fuel injector	4		Electric connection faces down	
4	Seal	4		Replace	
5	Protective sleeve	4		Replace, press on and be careful not to damage injector needle	
6	Seal	4		Replace	
7	Washer	4			

Installing Fuel Injectors

Installing Instructions

1. Apply a thin coat of oil to lower seal and press fuel injectors into bores of intake manifold separately.
2. Then push fuel distributor pipe on fuel injectors and mount retaining clamps.

ADJUSTING IDLE SPEED
MODELS FROM 85/2 AND 924 S

T o o l s

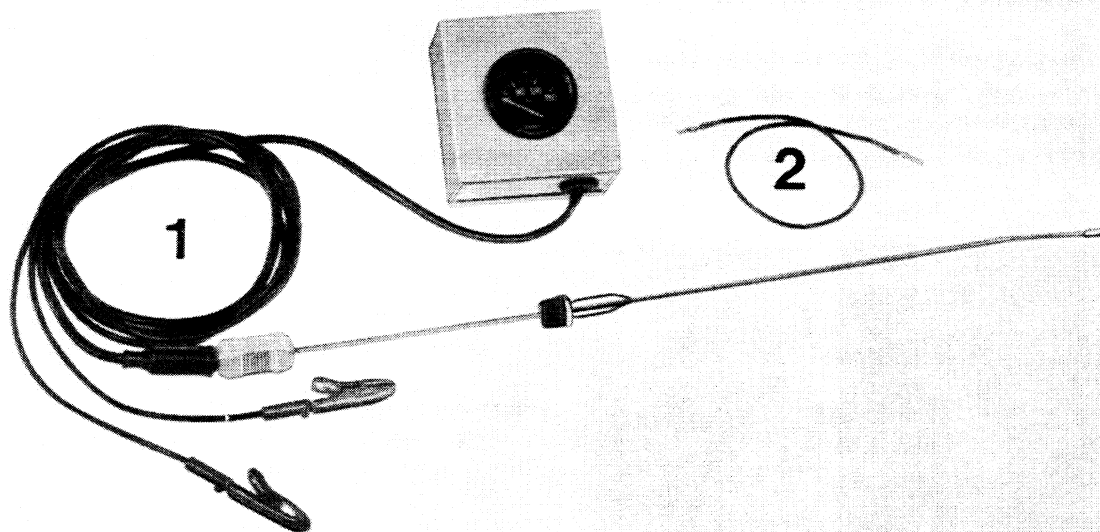

No.	Description	Special Tool	Remarks
1	Oil temperature tester with sensor	9122 + 9122/2	
2	Locally made lead		

ADJUSTING IDLE SPEED

Adjusting Requirements

Engine in perfect running condition. Electric equipment switched off for duration of adjustments. Adjustments carried out as quickly as possible to avoid excessive heat in intake ports and consequently incorrect CO level. Ambient temperature 15 to 35° C.

1. Run engine to operating temperature (70 to 90° C oil temperature), checking temperature with Special Tool 9122 + 9122/2 (oil temperature tester).

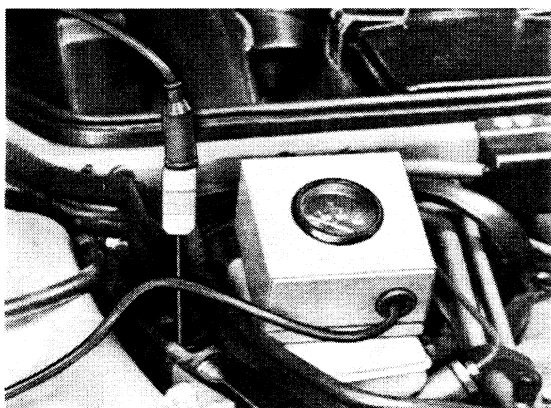

2. Check CO level. If CO level is not within specified limits, it must be corrected on the air flow sensor.

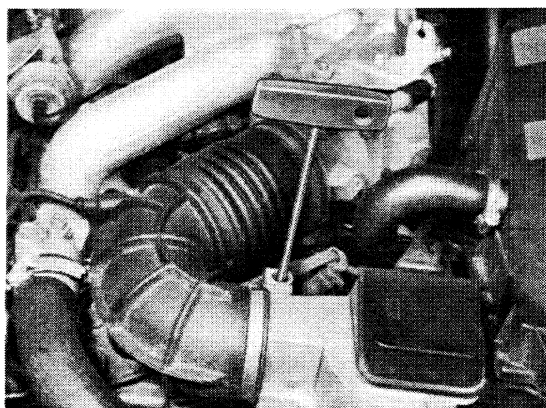

CO level specification: 0.5 to 1.5 % by vol..
 Turned clockwise = richer mixture.
 Turned anticlockwise = leaner mixture.

3. Connect a separate tachometer to instructions supplied with it. Idle speed specification: 840 ± 20 rpm.
4. Check and/or adjust idle speed. This requires stopping operation of the idle speed filling control.
 - a.) Bridge round female plugs B and C on diagnosis plug with a locally made test lead. This stops operation of the idle speed filling control.

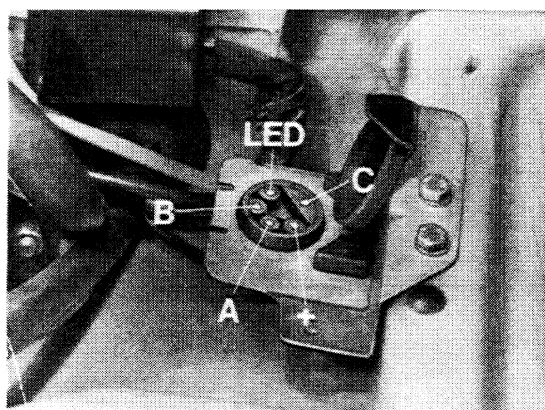

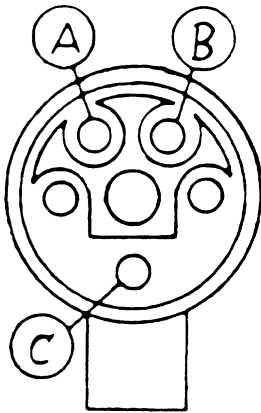

- b.) Check and adjust engine idle speed with VAG tester 1367.
5. Turn control screw (bypass) on throttle housing until specified speed of 840 ± 20 rpm is reached.

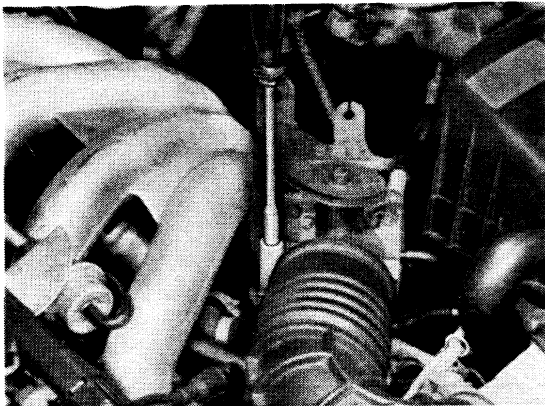

6. Restore operation of idle speed filling control (remove locally made lead on diagnosis plug) after finishing adjustments.
7. Recheck adjusted values.

ADJUSTING IDLE SPEED - USA - AND CATALYTIC CONVERTER CARS,
MODELS FROM 85/2 AND 924 S

T o o l s

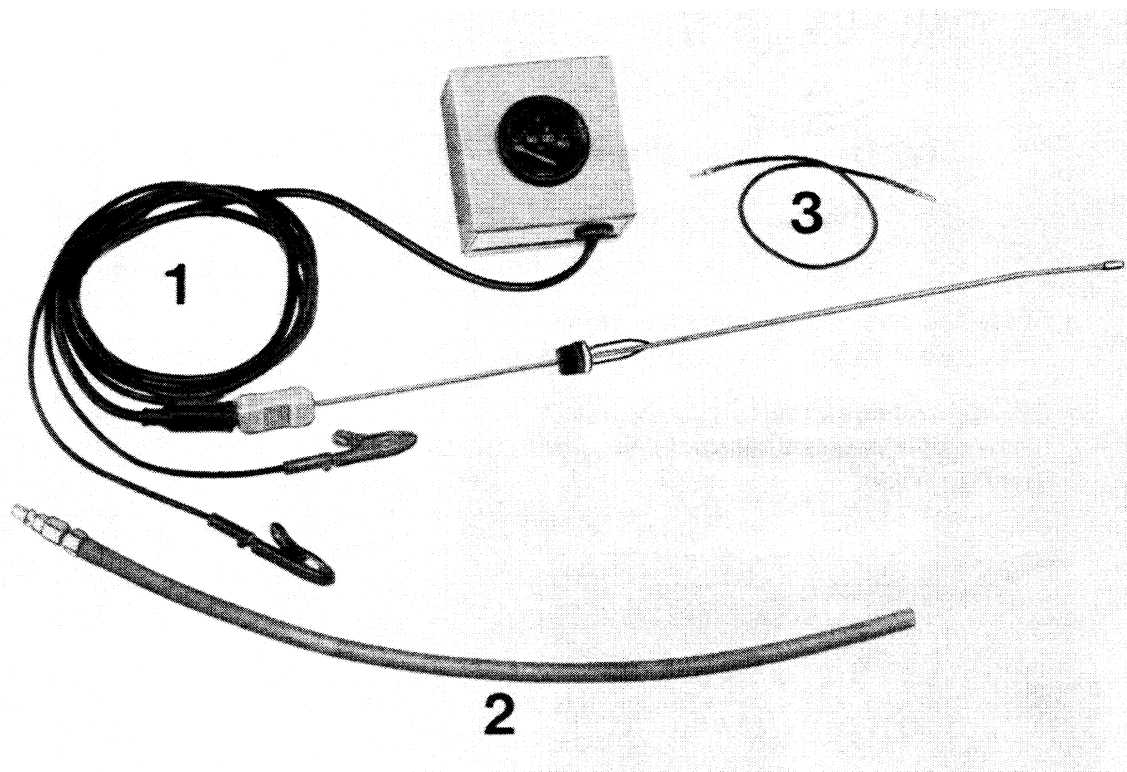

No.	Description	Special Tool	Remarks
1	Oil temperature tester with sensor	9122 + 9122/2	
2	Exhaust sensor	US 4492	
3	Locally-made lead		

ADJUSTING IDLE SPEED – USA and Catalytic Converter Cars

Note:

Adjusting Requirements

Engine in perfect running condition. Electric equipment switched off for duration of adjustments. Adjustments carried out as quickly as possible to avoid excessive heat in intake ports and consequently incorrect CO level. Ambient temperature 15 to 35° C.

1. Slide exhaust testing line or exhaust sensor US 4492 on to CO testing pipe.

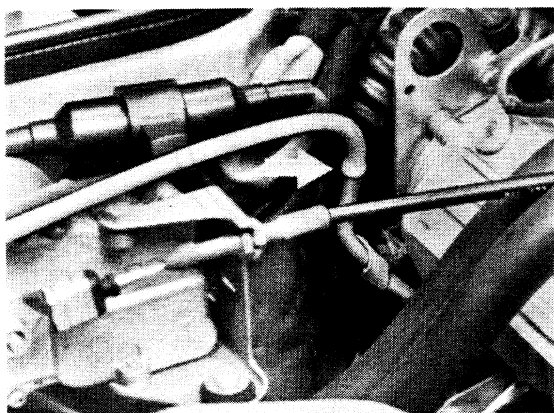
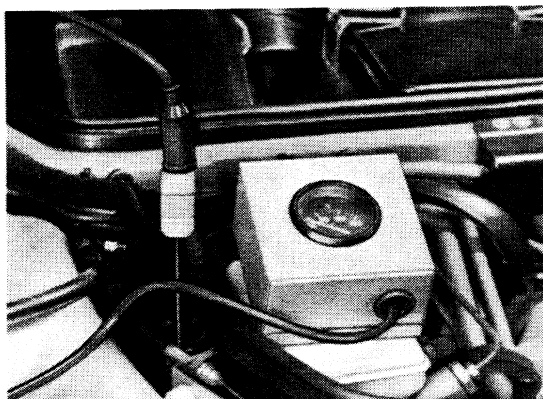

3. Disconnect oxygen sensor plug and connect CO tester to supplied instructions.

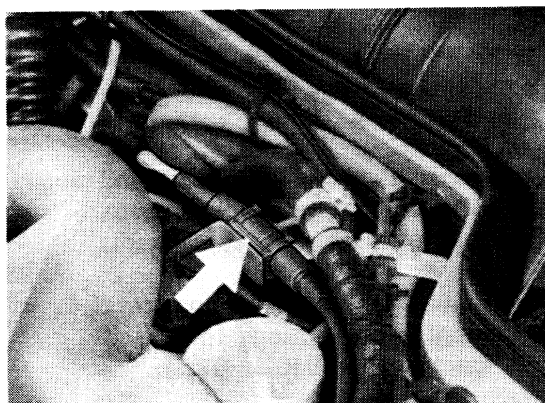

2. Run engine to operating temperature (70 to 90° C oil temperature), checking temperature with Special Tool 9122 + 9122/2 (oil temperature tester).

4. Check CO level. Correct CO level adjustment on the air flow sensor, if it is not within specified limits.

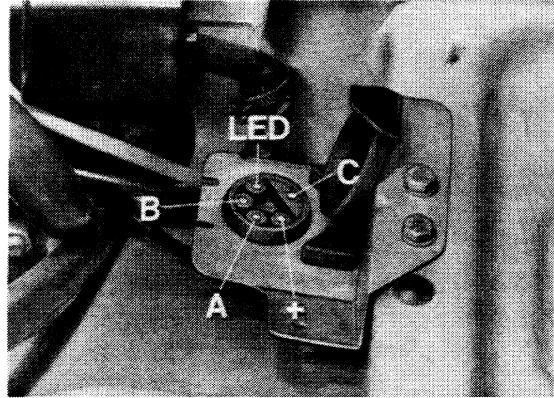
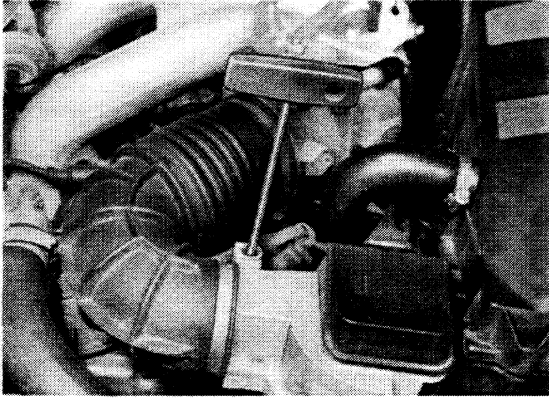

CO level specification: 0.6 ± 0.2 % by vol.
 Turned clockwise = richer mixture.
 Turned anticlockwise = leaner mixture.

Note

If the CO level has to be corrected on the air flow sensor, remove the air flow sensor to be able to take the plug out of the bore providing access to the idle speed CO adjusting screw.

5. Connect oxygen sensor plug and plug CO testing pipe in engine compartment after finishing adjustments.
6. Connect a separate tachometer to supplied instructions. Idle speed specification: 840 ± 20 rpm.
7. Check and adjust engine idle speed, which makes it necessary to stop the operation of the idle speed filling control.
 - a) Bridge round female plugs B and C on diagnosis plug with a locally made test lead. This stops operation of the idle speed filling control.
 - b) Check and adjust speed with, for example, VAG Tester 1367.
8. Turn control screw (bypass) on throttle housing until specified speed of 840 ± 20 rpm is reached.

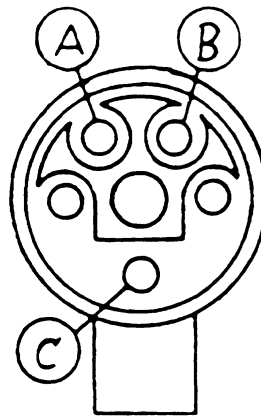

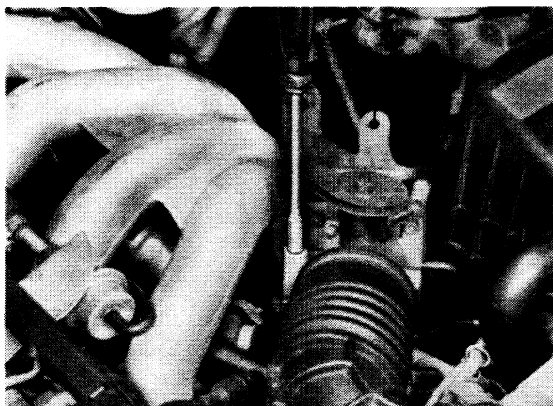

9. Restore operation of idle speed filling control by removing locally made lead on diagnosis plug after finishing adjustments.
 10. Recheck adjusted values.
-

Testing and adjusting specifications

Engine type M 44.11/12 (2.7 l)

Test	Specification	Remarks	
Electric fuel pump Delivery rate	at least 850 cm ³ /30 s		
Fuel pressure (engine stationary) DME relay bypassed	3.8 ± 0.2 bar		
Control value at idle	approx. 3.3 bar		
Leak test minimum pressure after 20 min.	2.0 bar		
Idle setting	without catalytic converter	USA and catalytic converter vehicles	
Idle speed rpm	840 ± 40	840 ± 40	* Measured upstream of the catalytic converter and with the Lambda probe plug disconnected
CO content %	0.5 - 1.5	0.4 - 0.8*	
HC value ppm	≤ 300	≤ 300*	

Note

The system fuel pressure has been increased from 2.5 bar to 3.8 bar. The test connection to check the fuel pressure remains the same. Carry out the working procedure CHECKING FUEL PRESSURE as described on Pages 24 - 5 to 24 - 6. Tightening torque for the cap nut 12 Nm.

Adjusting idle speed and CO

As from Model 89

Engine type M 44. 11/12 (2.7 l)

Note

Carry out the working procedure ADJUSTING IDLE SPEED/CO as described on Pages 24-17 to 24-23.

Vehicles without catalytic converter

Idle speed = 840 ± 40 rpm

CO = 0.5 - 1.5% (measured in the final exhaust pipe)

Vehicles with catalytic converter

Idle speed = 840 ± 40 rpm

CO = 0.4 - 0.8 % (measured upstream of the catalytic converter,
Lambda probe plug disconnected)

Equipment table

As from model 89

Engine type M 44 11/12 (2.7 l)

Electric fuel pump	Fuel filter	Fuel pressure damper	Fuel pressure regulator
-----------------------	-------------	-------------------------	----------------------------

944.608.102.06 Bosch No. 0580.464.042	928.110.253.00 Purolator No. 506.883.901.5	944.110.201.04 Bosch No. 0280.161.036	944.110.198.06 Bosch No. 0280.160.287
---	--	---	---

Air flow sensor	NTC temperature sensor II	Throttle valve switch	Idle speed controller
--------------------	---------------------------------	-----------------------------	--------------------------

944.606.121.01 Bosch No. 0280.202.064	944.606.125.00 Bosch No. 0280.130.026	944.606.113.01 Bosch No. 0280.120.308	930.606.161.00 Bosch No. 0280.140.501
---	---	---	---

Electric injection valve	DME control unit
--------------------------	------------------

944.606.114.00 Bosch No. 0280.150.824	944.618.121.06 Bosch No. 0261.200.089
---	---

CHECKING TIGHTNESS OF EXHAUST SYSTEM FLANGES

1. Check tightness of hexagon nuts on exhaust manifold/cylinder head.
2. Check tightness of hexagon nuts on exhaust manifold/primary muffler flange.

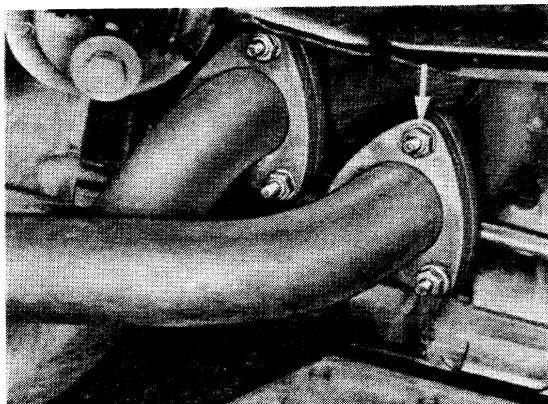

3. Check tightness of hexagon nuts on primary muffler/final muffler flange.

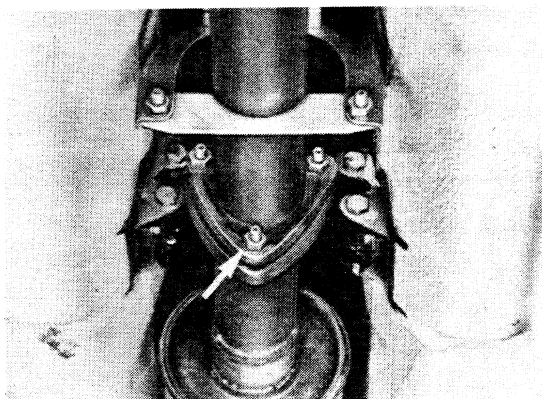

Tightening torque for M 8 bolts and nuts: 20 + 2 Nm
(2.0 + 0.2 kpm).

REPLACING EXHAUST PIPE OR PRIMARY MUFFLER /
CATALYTIC CONVERTER

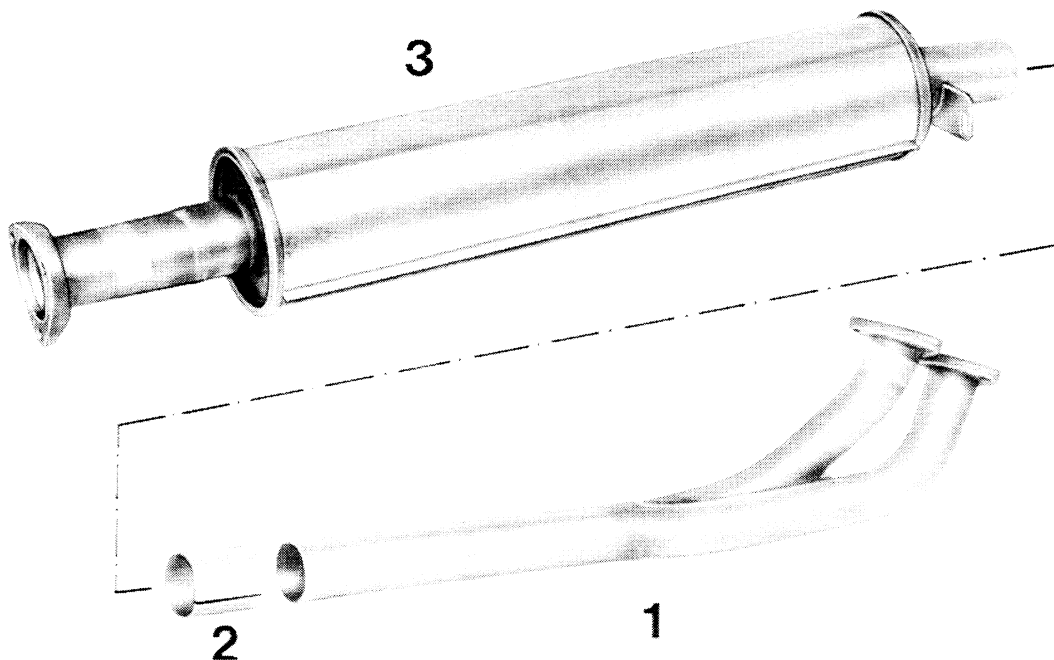

No.	Description	Qty.	Removing	Note When: Installing	Special Instructions
1	Exhaust pipe	1			
2	Sleeve	1			
3	Primary muffler	1			

REPLACING EXHAUST PIPE OR PRIMARY MUFFLER / CATALYTIC CONVERTER

1. Remove complete primary muffler or catalytic converter.
Mark cutting point and saw off exhaust pipe (cutting plane perpendicular to pipe axis, dimensions in mm).

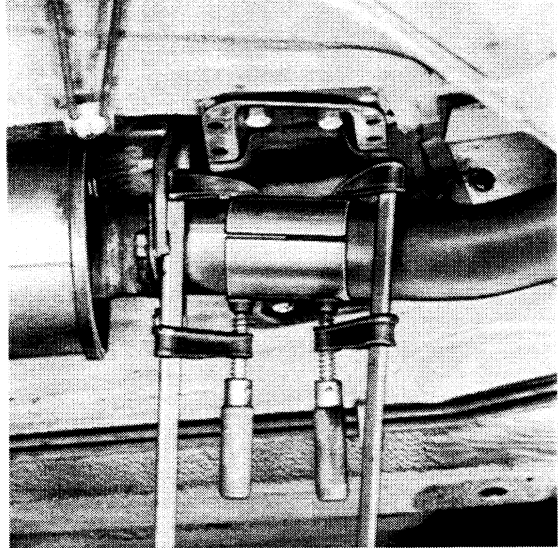
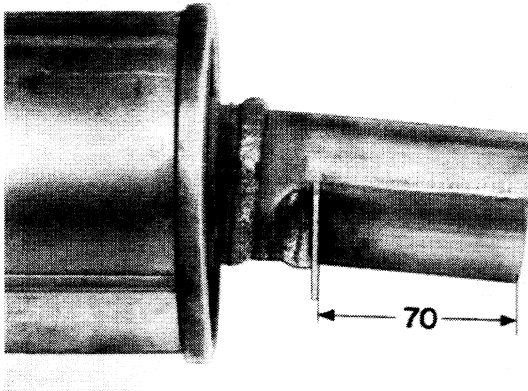

2. Mount new parts on car, using old gaskets and nuts at first.
3. Align exhaust assembly with connecting sleeve to be without stress and tack weld sleeve at several points to keep the parts in installed position.
4. Remove exhaust assembly and weld sleeve all around.
5. Use new gaskets and mounting nuts for final installation.

AUTOMATIC CRUISE CONTROL
(TEMPOSTAT)

AUTOMATIC CRUISE CONTROL
(TEMPOSTAT)

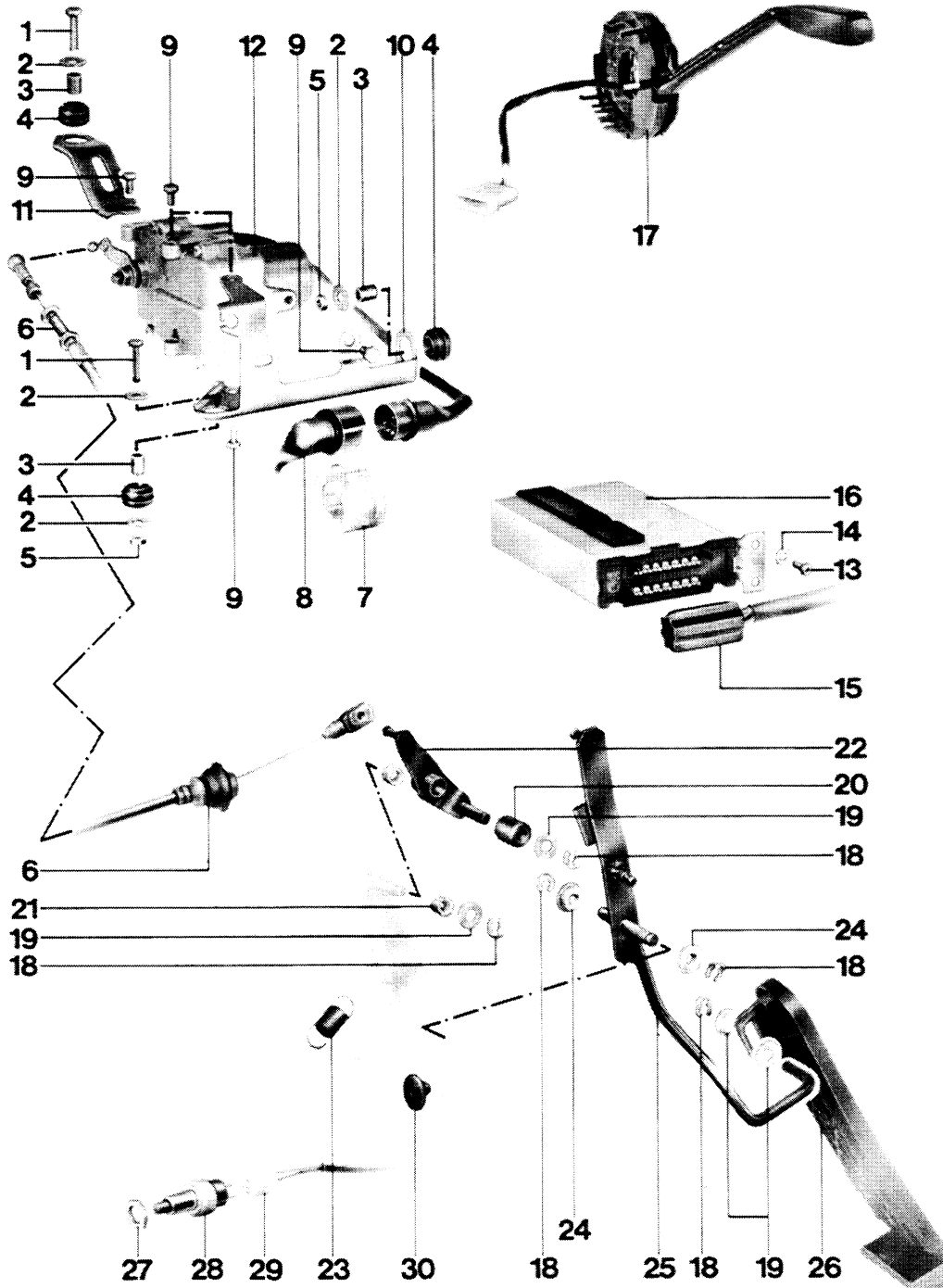

No.	Description	Qty.	Note When:		Special Instructions
			Removing	Installing	
1	Bolt M 6 x 25	2			
2	Washer	4			
3	Spacer	3			
4	Rubber grommet	3			
5	Nut M 6	2			
6	Cable	1			
7	Plug holder	1			
8	Plug	1			
9	Bolt M 6 x 10	4			
10	Drive holder	1			
11	Drive holder	1			
12	Drive	1			
13	Screw	2			
14	Washer	2			
15	Plug	1			
16	Control unit	1			
17	Switch	1			
18	Lock washer	5			

No.	Description	Qty.	Note When:		Special Instructions
			Removing	Installing	
19	Washer	4			
20	Roller	1			
21	Sleeve	2			
22	Operating lever	1			
23	Pull spring	1			
24	Sleeve	2			
25	Accelerator lever	1			
26	Accelerator pedal	1			
27	Nut	2			
28	Clutch switch	1			
29	Plug	1			
30	Rubber stop	1			

REMOVING AND INSTALLING CONTROL UNIT FOR CRUISE CONTROL

1. Turn off ignition.

2. Unscrew trim panel in footwell on driver's side.

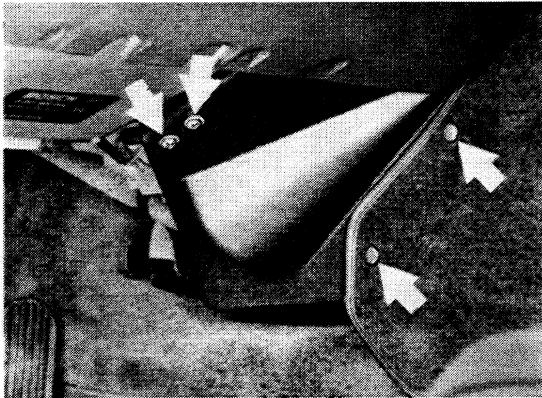

4. Pull off multiple pin plug after pulling out control unit slightly.



3. Unscrew control unit mounting bolts.

5. Remove control unit.



REMOVING AND INSTALLING CRUISE CONTROL SWITCH (STEERING COLUMN SWITCH)

1. Disconnect battery.

2. Pull off cover by hand.

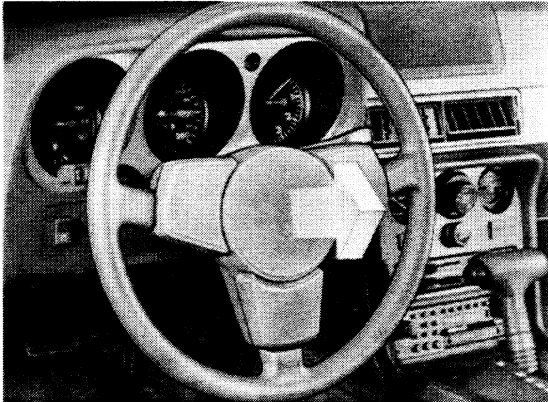

4. Unscrew steering column switch and take off casing.

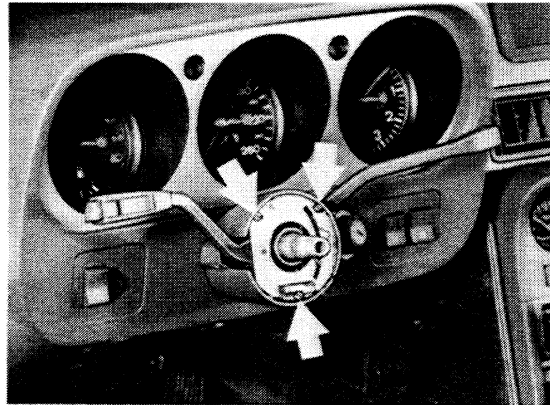

3. Unscrew casing mounting screws.

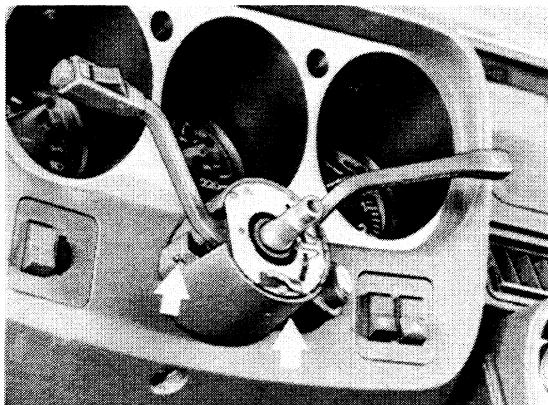

5. Pull off multiple pin plug on steering column switch.

Pull out four-pin plug of control switch from underneath the instrument panel and disconnect.

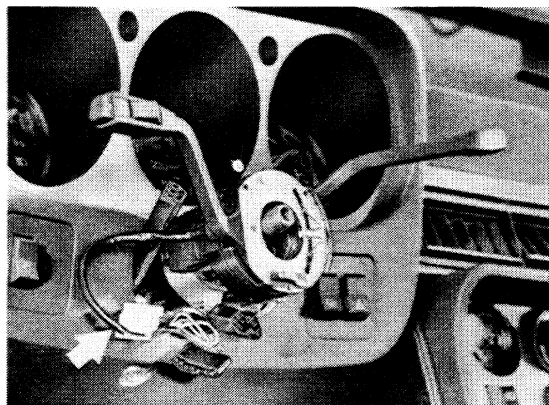

REMOVING AND INSTALLING CONTROL UNIT FOR CRUISE CONTROL

1. Turn off ignition.

2. Unscrew trim panel in footwell on driver's side.

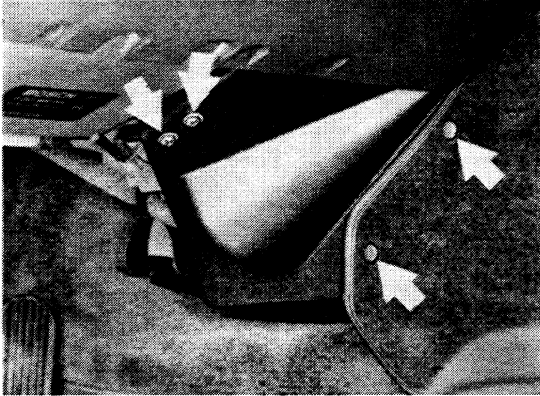

4. Pull off multiple pin plug after pulling out control unit slightly.

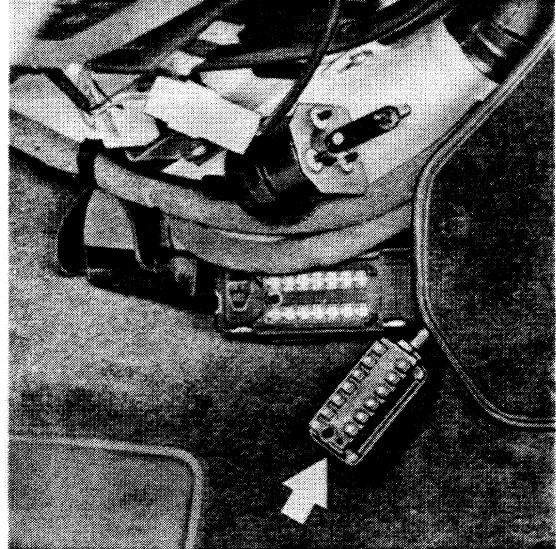

3. Unscrew control unit mounting bolts.



5. Remove control unit.

REMOVING AND INSTALLING CRUISE CONTROL SWITCH (STEERING COLUMN SWITCH)

1. Disconnect battery.

2. Pull off cover by hand.

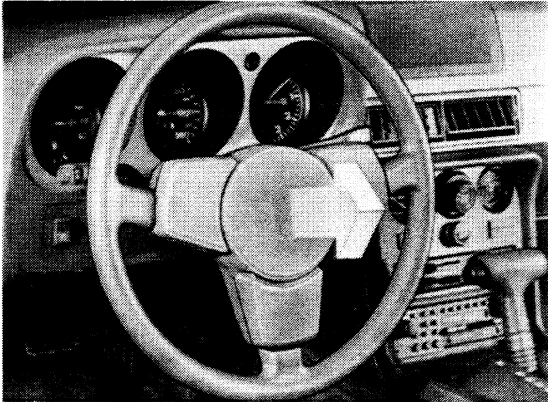

4. Unscrew steering column switch and take off casing.

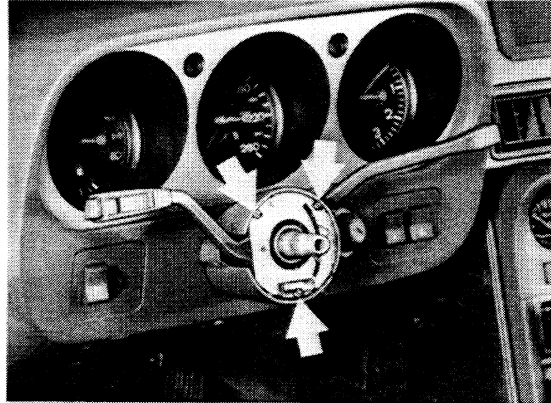

3. Unscrew casing mounting screws.

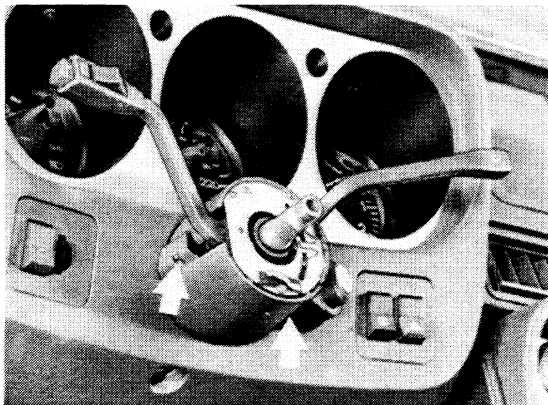

5. Pull off multiple pin plug on steering column switch.

Pull out four-pin plug of control switch from underneath the instrument panel and disconnect.

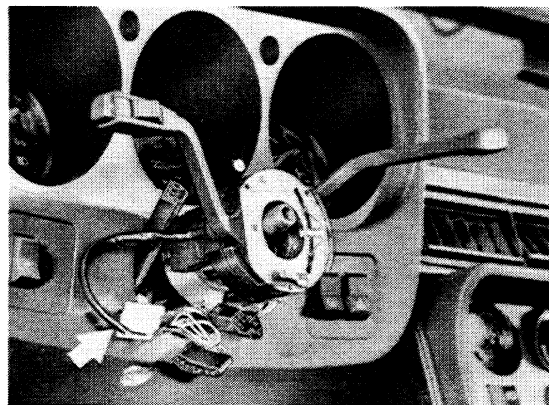

6. Cruise control switch and turn signal switch make up a single unit. Two retaining tabs must be disengaged and the switches pulled apart, in order to separate the turn signal switch and wiper switch.

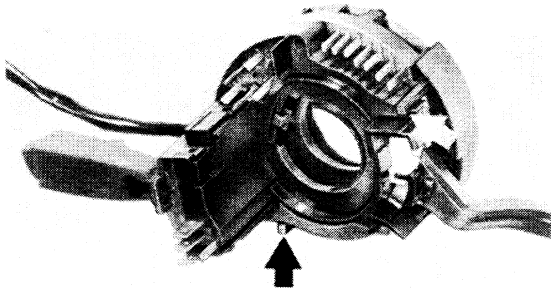

3. Press off cable on ball head of operating lever.

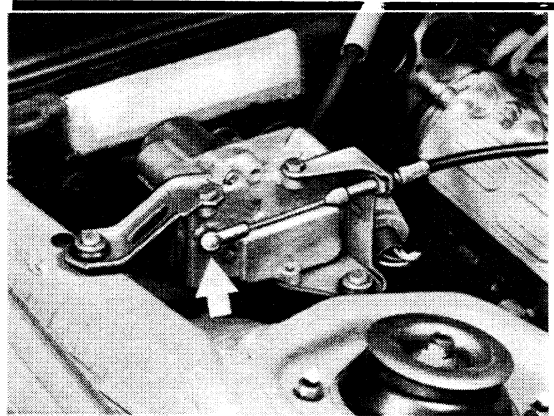

4. Unscrew lock nut on cable adjusting screw completely and disconnect cable.

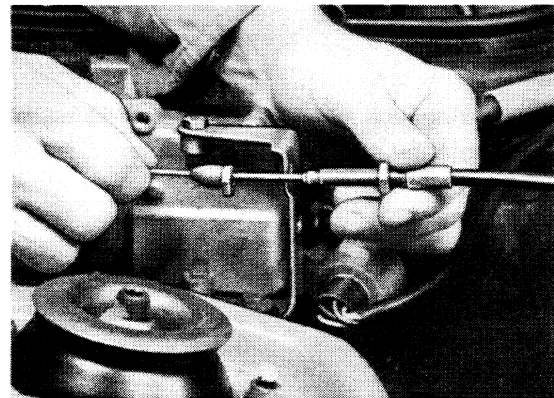

REMOVING AND INSTALLING DRIVE

1. Turn off ignition.
2. Open holder for multiple pin plug and disconnect plug.

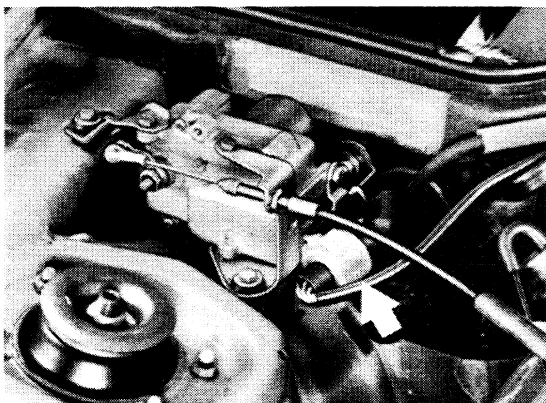

5. Unscrew mount on body and holder on drive.

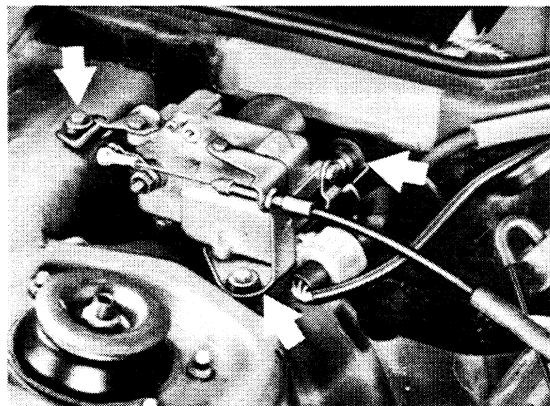

REMOVING AND INSTALLING CRUISE CONTROL CABLE

1. Press off cable on ball head of operating lever.

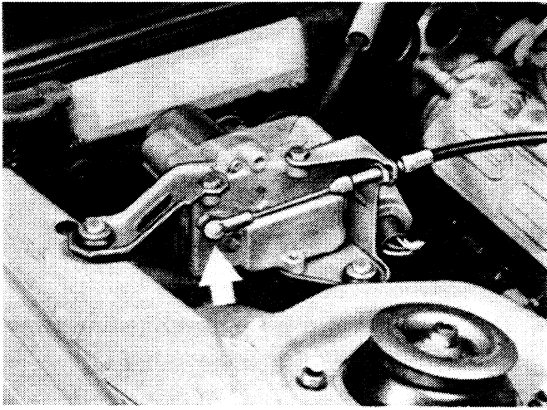

3. Press off cable on control lever above accelerator pedal.
Cable mount has no additional lock.

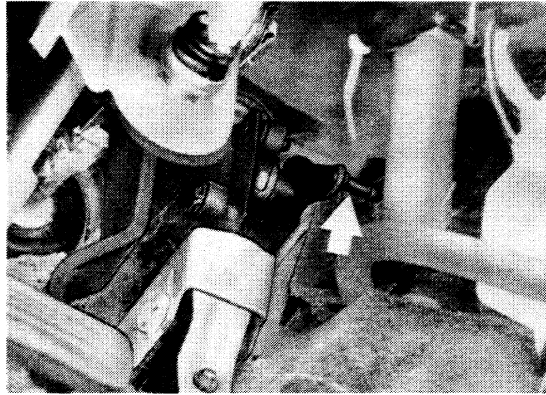

2. Unscrew lock nut on cable adjusting screw completely and disconnect cable.

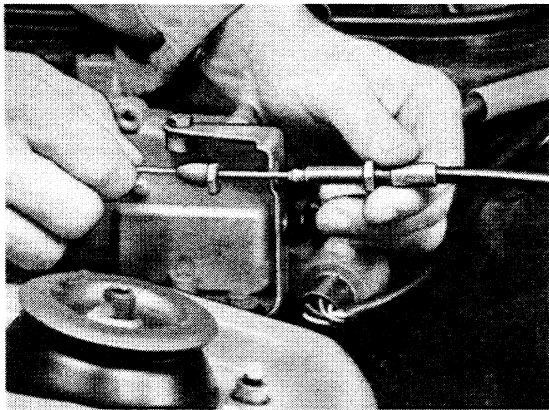

4. Press rubber grommet out of compartment wall and pull out together with the cable.

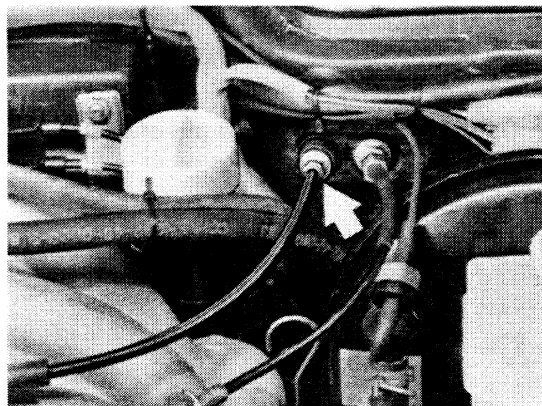

Adjusting**Requirements:**

Accelerator pedal cable and, if car has automatic transmission, control cable must be adjusted as specified.

Adjust cruise control cable that control lever with roller rests on accelerator lever above the accelerator pedal without stress. Operate lever on drive by hand. The operated throttle must return to idle position afterwards, since otherwise coasting shutoff would malfunction among others.

REMOVING AND INSTALLING CLUTCH SWITCH
Note:

Cars with automatic transmission do not have this switch.

1. Pull off two-pin plug on clutch switch.



2. Unscrew lock nut and remove switch.

Adjusting

Adjust clutch switch that distance between end of threads and clutch pedal in neutral position is 4 mm.

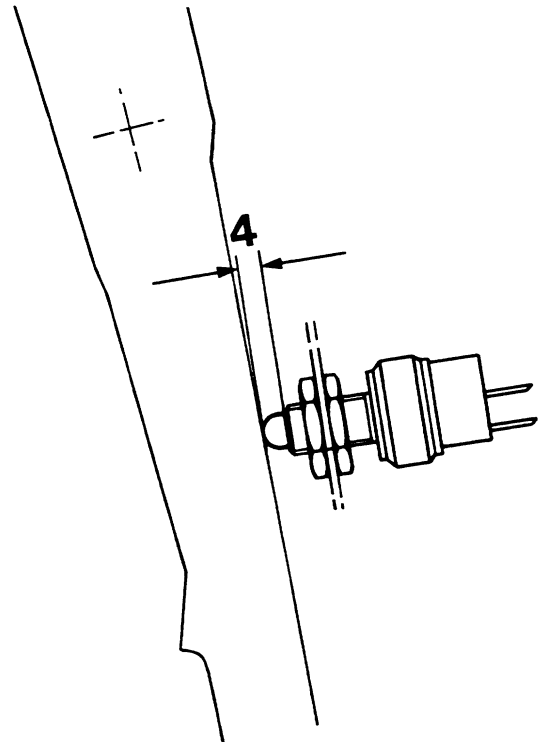

Points are closed in neutral position.

TROUBLESHOOTING CRUISE CONTROL

First check the following points if automatic cruise control malfunctions.

If a defect is not found while checking these points, troubleshooting must be continued on the control unit multiple pin plug and drive.

1. Check cable for damage and correct adjustment.

2. Check fuse no. 8 on central electric board (stop light uses same fuse).

3. Check function of stop lights.
Terminal 8 of control unit for cruise control will have ground potential from the stop light bulb filament when brake pedal is not operated.
Should both stop light bulbs be defective simultaneously, the control unit cannot function because the connection with car ground is interrupted.

4. Check function of clutch switch.

Switch must be closed in neutral position (ground switched to control unit terminal 14).

See "Removing and Installing Clutch Switch" for adjustments.

TESTING MULTIPLE-PIN PLUG FOR CONTROL UNIT FOR CRUISE
CONTROL WITH AN OHMMETER

1. With ignition off, pull multiple-pin plug on control unit.

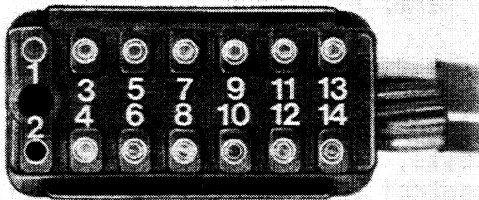

2. Connect tester to term. 1 (+) and term. 12 (ground) on multiple-pin plug. Switch on ignition.

Reading = battery voltage

3. Connect tester to term. 12 and term. 3.
Reading = battery voltage

Operate "off" switch on control switch.

Reading = 0 volt

4. Connect tester to term. 12 and term. 4.

Reading = 0 volt

Operate "ON/ACCELERATE"

Reading = battery voltage

5. Connect tester to term. 12 and term. 6.

Reading = 0 volt

Press "MEMORY" button

Reading = battery voltage

6. Connect tester to term. 12 and term. 8.

Reading = 0 volt

Operate brake

Reading = battery voltage

7. Connect tester term. 1 (Positive) term. 14.

Reading = battery voltage

Operate clutch (switch breaks).

Reading = 0 volt

8. Connect tester to term. 12 and term. 11 (Hall pulse generator) transmitter.

Turn left front wheel slowly by hand. Voltage must rise and drop from less than 1 V to greater than 6 V per wheel revolution (rectangular pulse).

4. Connect tester to term. 2 and term. 4 (potentiometer +).

Reading = 2 to 4 kohm

5. Connect tester to term. 2 and term. 3. (potentiometer sliding contact).

Reading = 2 to 4 kohm

6. Connect tester to term. 5 and term. 6 (clutch actuator).

Reading = 30 to 40 Ohm

CHECKING MULTIPLE-PIN PLUG ON CRUISE CONTROL DRIVE WITH AN OHMMETER

1. Switch off ignition.

2. Disconnect plug in engine compartment.

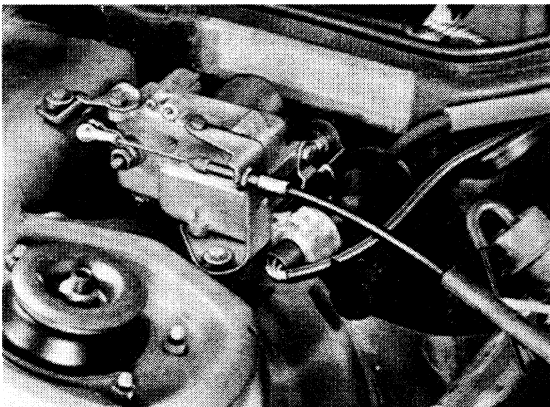

3. Connect tester to term. 1 and term. 7 on plug half of drive (engine resistance).

Reading = 3 bis 15 ohm

If no defect can be detected by these tests, check wire harness to control unit for cruise control. If necessary, replace control unit.

AUTOMATIC CRUISE CONTROL (TEMPOSTAT) FROM 85/2 MODEL

AUTOMATIC CRUISE CONTROL (TEMPOSTAT) FROM 85/2 MODEL

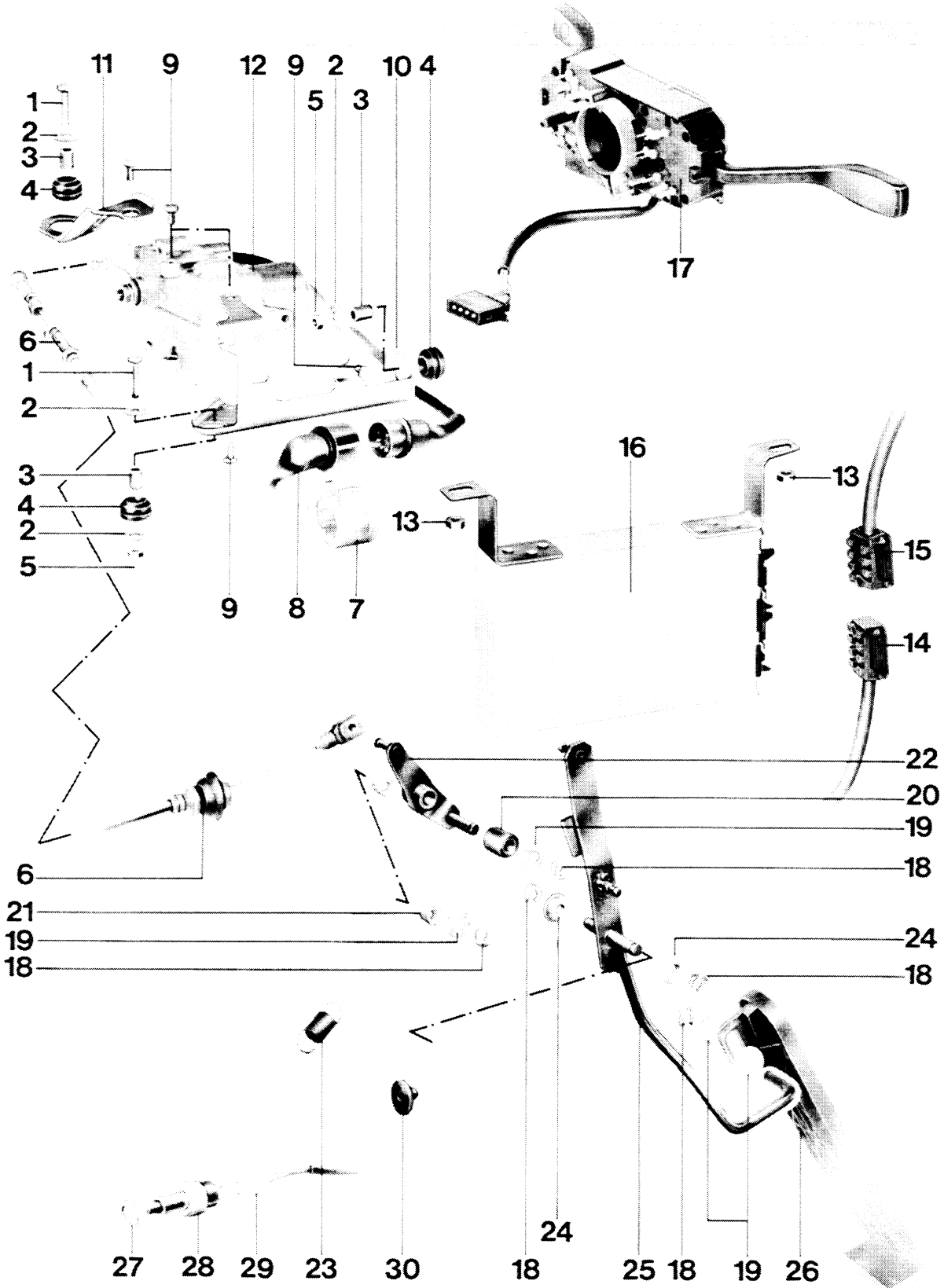

27 - 14 Automatic Cruise Control (Tempostat)

Printed in Germany

No.	Description	Qty.	Note When:	
			Removing	Installing
1	Hex - bolt M 6 x 25	2		
2	Washer	4		
3	Spacers	3		
4	Rubber grommet	3		
5	Hex nut M 6	2		
6	Bowden cable	1		
7	Plug holder	1		
8	Plug	1		
9	Hex bolt M 6 x 10	4		
10	Drive holder	1		
11	Drive holder	1		
12	Drive	1		
13	Nut M 6	2		
14	Front end cable plug	1		
15	Instrument cable plug	1		
16	Control unit	1		
17	Operating switch	1		

No.	Description	Qty.	Note when:	
			Removing	Installing
18	Lock washer	5		
19	Washer	4		
20	Roller	1		
21	Bushing	2		
22	Reverse-transfer lever	1		
23	Extension spring	1		
24	Bushing	2		
25	Accelerator lever	1		
26	Accelerator pedal	1		
27	Hex nut	2		
28	Clutch switch	1		
29	Plug	1		
30	Rubber stop	1		

REMOVING AND INSTALLING CONTROL UNIT FOR CRUISE CONTROL

N o t e

The control unit is located on the left in the driver's side footwell underneath the instrument panel.

1. Switch off ignition.
2. Remove circlip.
3. Remove both multiple plugs.
4. Unscrew fastening nuts on control unit.
5. Pull out control unit.

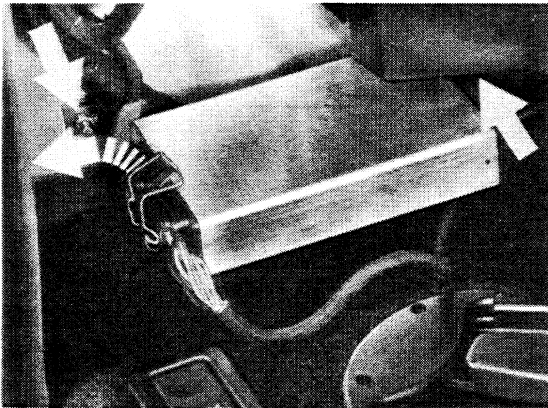

REMOVING AND INSTALLING STEERING COLUMN SWITCH

1. Disconnect battery.
2. Pull off cover by hand.
Unscrew hex nut and remove steering wheel.

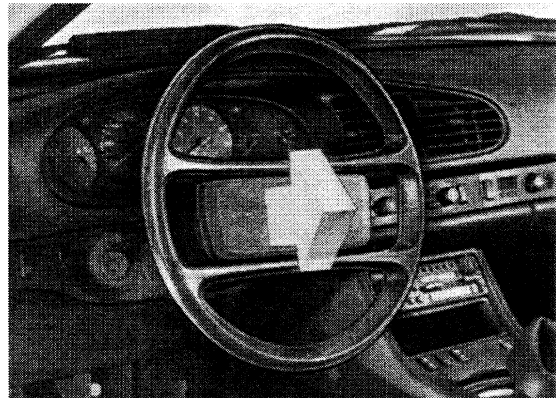

3. Unscrew and remove steering column switch cover.

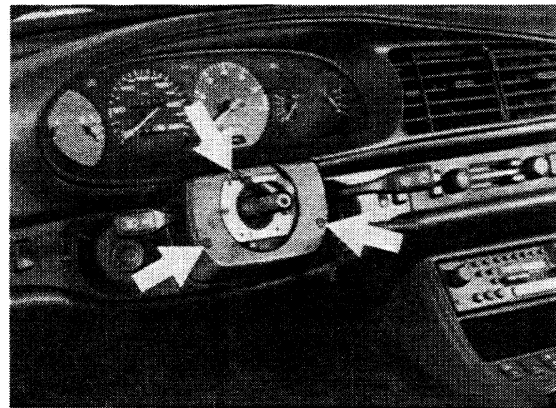

4. Remove buttons on heater control switch. Using a putty knife, carefully push down switch cover.

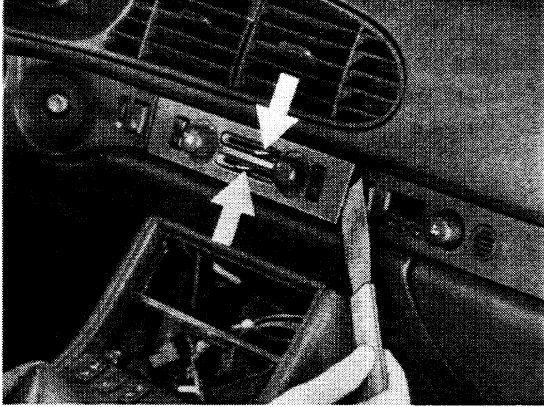

6. Loosen but do not unscrew steering column switch fastening screw. Pull out steering column switch and disconnect plugs. Pull out four-pin plug of control switch from underneath the instrument panel and disconnect.

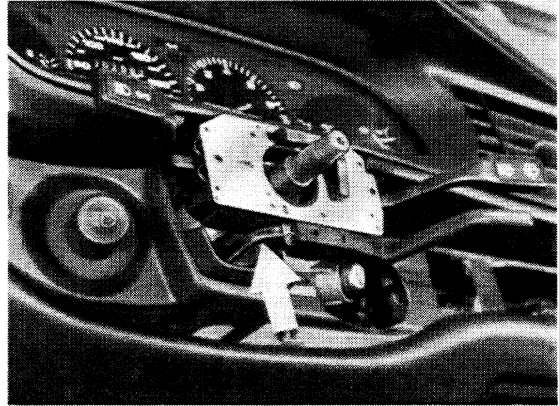

5. Unscrew fastening screws for control switch and cover on steering lock.

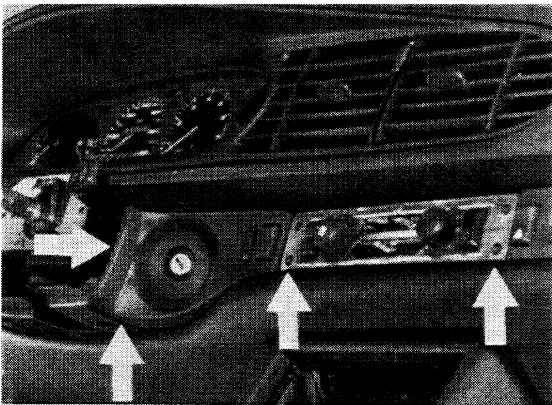

REMOVING AND INSTALLING DRIVE.

1. Switch off ignition.

2. Open holder for multiple-pin plug and disconnect plug.

3. Press off cable retaining clip.

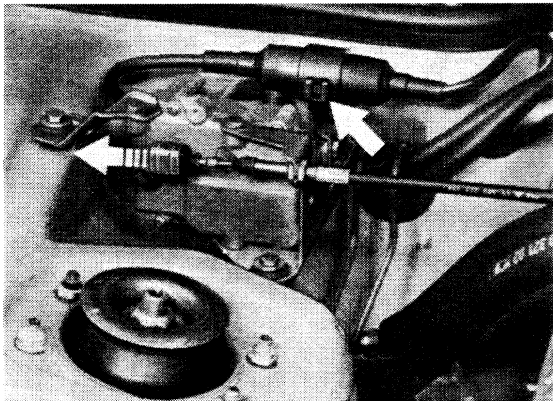

5. Unscrew mount on body and remove holder from drive.

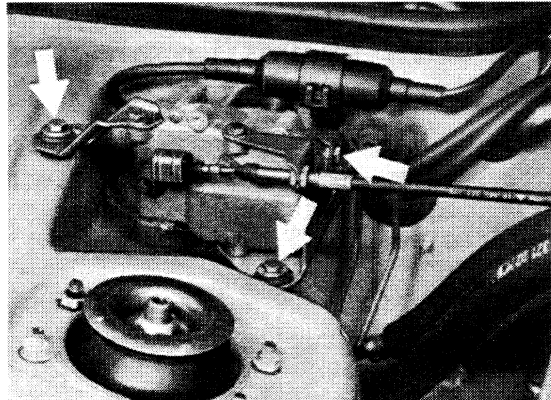

4. Unscrew lock nut on cable adjusting screw completely and disconnect cable.

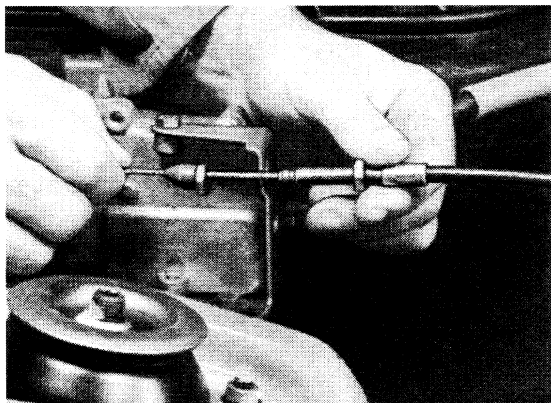

REMOVING AND INSTALLING CLUTCH SWITCH

Note

Instead of the switch, cars with automatic transmission have a bridge.

1. Unscrew cover on central electric console in driver's side of footwell. (3 nuts)

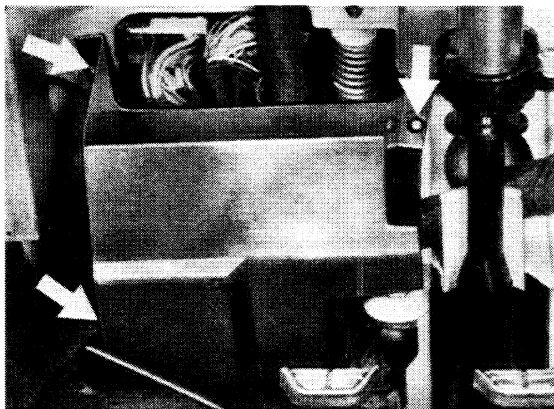

2. Pull off two-pin plug on clutch switch.

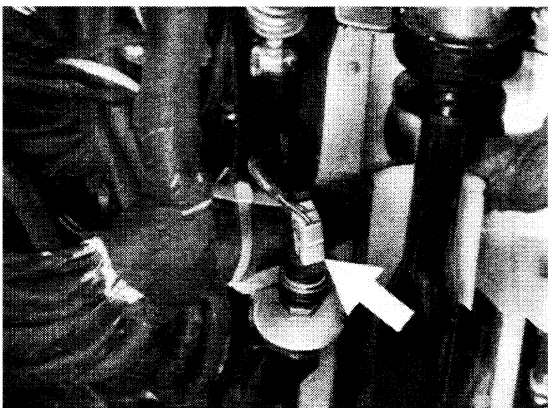

3. Unscrew lock nut and remove switch.

Adjusting

Adjust clutch switch so that the interval between the end of the threads and the clutch pedal in neutral position is 4 mm.

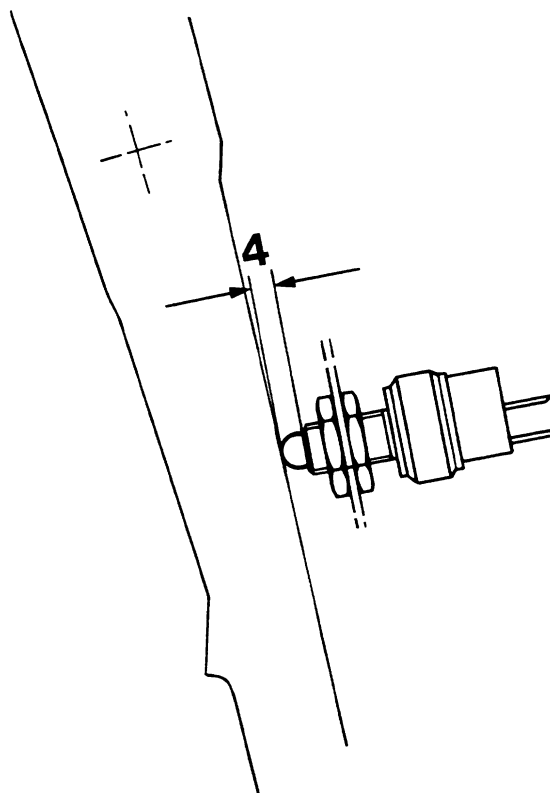

In neutral position the contacts are closed.

CRUISE CONTROL TROUBLESHOOTING

If no defect is found while checking these points, troubleshooting must be continued on the control unit multiple-pin plug.

In case of automatic cruise control malfunctions, check the following points first:

1. Check cable for damage and correct adjustment.
2. Check fuse and No. 19 in central electric console. The brake light uses the same fuse.
3. Check function of brake lights. Terminal 2, plug 1 of the control unit for cruise control will have ground potential from the brake-light bulb filament when the brake pedal is not operated. If both brake-light bulbs are simultaneously defective, the control unit cannot function because the connection with the car ground is interrupted.
4. Check function of clutch switch.

The switch must be closed and in neutral position (switches ground to control unit term. 7, plug 1)

PLUG ASSIGNMENT, CONTROL UNIT FOR
CRUISE CONTROL

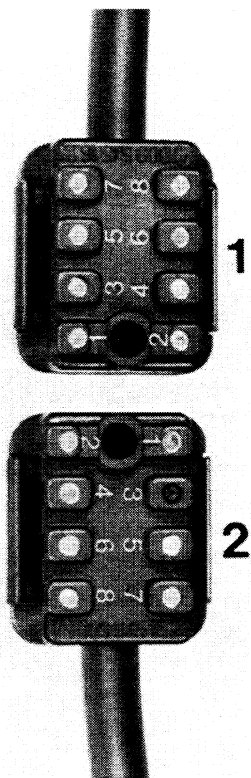

Plug 1 - Instrument Cable

Plug 2 - Front End Cable (Drive)

Plug 1

- 1.Speedometer signal
- 2.Brake lights
- 3."Switch off"
- 4.Term. 15
- 5.Switch "Resume"
- 6.Switch "On/Accelerate"
- 7.Clutch switch
- 8.Term. 31

Plug 2

- 1.Clutch
- 2.Clutch
- 3.Coding plug
- 4.Potentiometer, negative
- 5.Engine, positive
- 6.Engine, negative
- 7.Potentiometer, positive
- 8.Potentiometer, sliding contact

N o t e

Plug 2 has coding, in order to
exclude the possibility of
incorrect connection.

CHECKING MULTIPLE-PIN PLUGS
OF CONTROL UNIT FOR CRUISE CONTROL

N o t e

Check Plug 1 with a voltmeter and Plug 2 with an ohmmeter.

1. With ignition off, pull off both multiple-pin plugs on control unit.
2. Connect testers to term. 4 (positive) and term. 8 (ground) on plug 1.

Switch on ignition.

Reading: Battery voltage
3. Connect testers to term. 2 and term. 8.

Reading: 0 volt
Operate brakes
Reading: battery voltage
4. Connect testers to term. 3 and term. 8.
Reading: battery voltage
Operate control switch to "Off"
Reading: 0 volt
5. Connect testers to term. 5 and term. 8.
Reading: 0 volt
Operate switch to "Resume"
Reading: battery voltage

6. Connect tester to term. 6 and term. 8
Reading: 0 volt
Operate switch to "On/Accelerate"
Reading: battery voltage"

7. Connect tester to term. 4 and term. 7.
Reading: battery voltage
Operate clutch
Reading: 0 volt

8. Place vehicle on lifting platform and lift until wheels freely turn.

Connect testers to battery + and term. 1.

Ignition off.
Reading: approx. 1 V below battery voltage.

Ignition on.
Reading: 0 V
Start engine, engage second gear and accelerate to 50 km/h.
Reading: approx. every 4 V.

Voltage will increase with speed.

N o t e

The speedometer signal can be tested more simply in vehicles with a lifting roof. Unlock lifting roof and accelerate vehicle to more than 5 km/h. The roof should lock automatically. Now use an ohmmeter to check continuity from lifting roof relay term. A to cruise control control unit plug 1 term. 1.

9. Connect ohmmeter term. 1 and term.
2 on plug 2.

Reading every 30 - 40 ohm

10. Connect tester to term. 4 and term.
7.

Reading: 2 - 4 kohm

11. Connect testers term. 4 and term. 8

Reading: every 2 - 4 kohm

12. Connect testers term. 5 and term. 6
Reading: every 20 - 30 ohm

If no defect can be located based on these
tests, replace control unit.

———

Removing and installing the alternator on vehicles with air-conditioning system

Removing

1. Disconnect the battery from ground.
2. Raise the vehicle and remove the engine guard.
3. Pull off the alternator's ventilation hose.
4. Release the tension on the Poly-rib drive belt and remove.

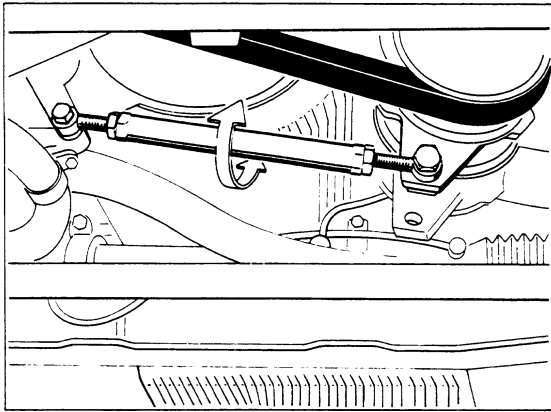

54/13

5. Disconnect and remove the air filter housing with air flow sensor.
6. Undo the fastening screws for the alternator and press the alternator out of the console with a screwdriver.
7. Remove the air box and separate all electrical connections.

Installing

Check the tension of the alternator's Poly-rib belt and adjust according to Page 13 - 1.
Tightening torque for the fastening screws
M 10 = 45 Nm.

EQUIPMENT SURVEY

Ignition Coil

Type/Model	Version	Remarks
944	944 602 115 00 Bosch No. 0 221 118 322	Without ballast resistors

Distributor (Cap)

Type/Model	Version	Remarks
944	944 602 251 00 Bosch No. 1 235 522 325	Only high voltage distribution

Spark Plugs

Type/Model	Version	Remarks
944	Bosch WR 8 DS Champion RN – 10 GY	Electrode gap 0.7 + 0.1 mm (0.028 + 0.004 in.)

DME Control Unit

Type/Model	Version	Remarks
944	944 618 111 01 Bosch No. 0 261 200 015	

Spark Plug Caps

Type/Model	Version	Remarks
944		Without series gap

DANGERS ON ELECTRONIC IGNITION SYSTEMS

The Type 944 is equipped with a digital engine electronic system (DME). In comparison to conventional systems the ignition power of DME is so high, that contact with current-carrying parts while engine is running could be fatal. Consequently the ignition must always be turned off or battery ground wire disconnected when doing any work on ignition system.

Such work would be:

1. Connecting engine testers.
2. Replacing ignition system parts.

If DME testing or engine tuning requires turning on the ignition, the dangerous current mentioned above will be in the DME ignition system.

Lightning bolts indicate the danger spots in the wiring diagram illustrated below.

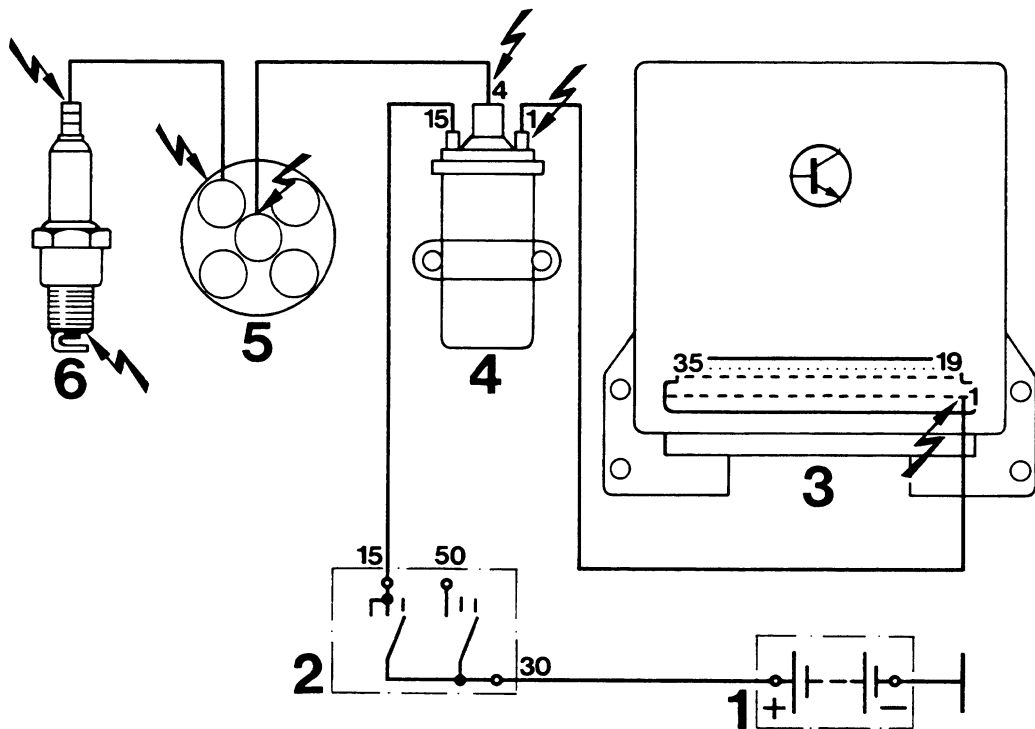

- 1 = Battery
- 2 = Ignition lock
- 3 = DME control unit

- 4 = Ignition coil
- 5 = Distributor
- 6 = Spark plug

REMOVING AND INSTALLING DISTRIBUTOR CAP

Note

To facilitate installation work we recommend changing a standard screwdriver into a locally made tool.

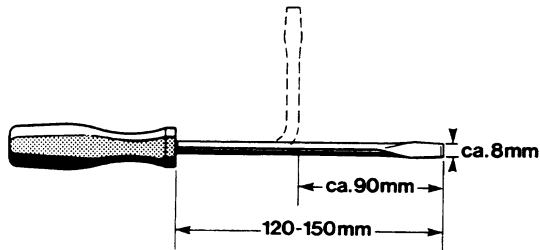

Heat screwdriver at bending point to glowing red and cool down slowly after bending.

Removing

1. Push in lower clamping hook with a suitable screwdriver and turn to the right.
2. Push in upper clamping hook and turn to the right.
3. Take off distributor cap.

Installing

1. Align distributor cap (locking boss on distributor cap must face up).
2. Align clamping hooks in distributor cap so that they are positioned horizontally and face toward left side as seen from front.

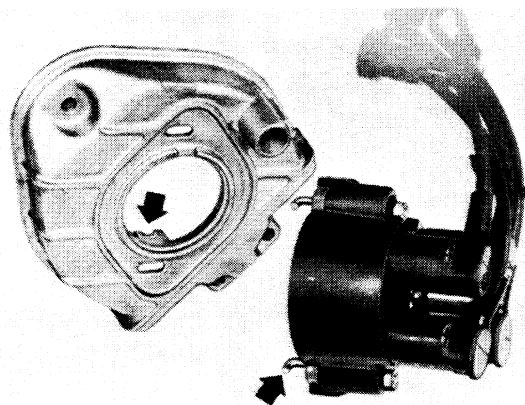

3. Guide clamping hooks into both slots and engage distributor cap by turning back and forth slightly. Watch position of dust cap.
4. Turn both clamping hooks against left stop. Press in clamping hooks far enough so that they can be turned counterclockwise further (approx. 1/4 turn) and engage when released.
5. Check that distributor cap fits tight. Clamping hooks must engage firmly.

REPLACING SPARK PLUGS

1. Pull off spark plug caps.
2. Unscrew spark plugs with a conventional wrench (e.g. Hazet No. 767-1). A spark plug wrench is provided in the car's tools.

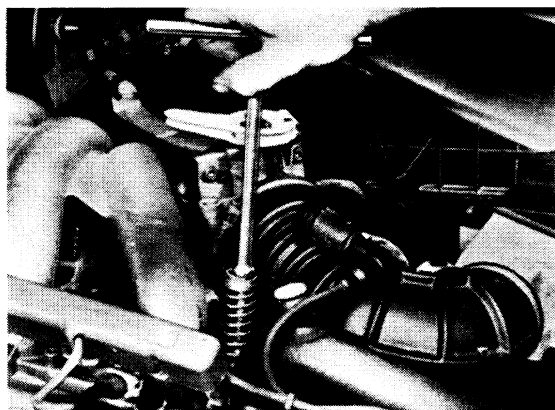

3. Give spark plug threads a light coat of graphite grease or similar (e.g. Molykote HTP White Paste).

Tightening torque: 25 to 30 Nm (18 to 22 ft lb).

DME (DIGITAL ENGINE ELECTRONICS)

DME (DIGITAL ENGINE ELECTRONICS)

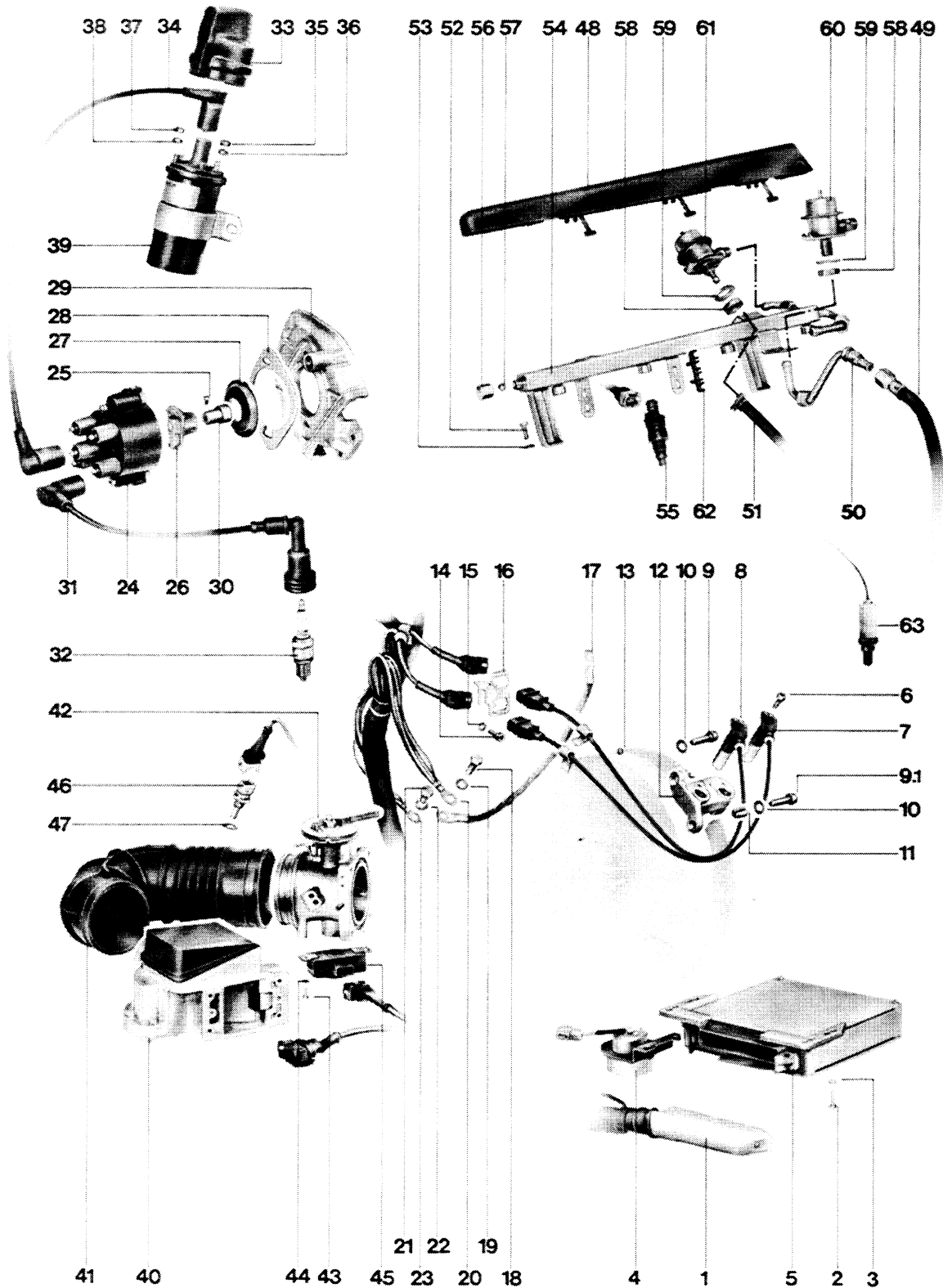

No.	Description	Qty.	Note When:		Special Instructions
			Removing	Installing	
1	Multiple pin plug for DME control-unit	1		Have plug engage firmly	
2	Screw B 4.8 x 18	4			
3	Washer A 5.3	4			
4	Altitude correction box	1			
5	DME control-unit	1	Essential that ignition is off.		
6	Bolt M 6 x 16	2		Torque: 8 Nm (6 ft lb)	
7	Speed sensor	1			
8	Reference mark sensor	1			
9	Bolt M 8 x 25	1			
9.1	Bolt M 8 x 30	1			
10	Washer A 8.4	2			
11	Key	1			
12	Bracket	1			
13	Stud M 6 x 16 for reference mark sensor	1	Heat to about 200 °C (400 °F)	Install with Loctite 270. Note 0.8 mm clearance	
14	Bolt M 6 x 15	1			
15	Washer A 6.4	1			
16	Holder	1			
17	Ground wire between body and engine	1			
18	Bolt M 8 x 20	1			
19	Washer A 8.4	1			

No.	Description	Qty.	Note When:		Special Instructions
			Removing	Installing	
20	Ground wire on clutch bell housing	1			
21	Bolt M 6 x 12	1			
22	Washer A 6.4	1			
23	Electronic ground on engine block	1			
24	Distributor cap	1			
25	Bolt M 4 x 6	1		Lock with Loctite 221	
26	Distributor rotor	1			
27	Dust cap	1			
28	Gasket	1			
29	Housing	1			
30	Dog	1			
31	Spark plug cap	4			
32	Spark plug	4			
33	Cover	1			
34	Ignition cable	1			
35	Nut M 6	1			
36	Lock washer B 6	1			
37	Nut M 5	1			
38	Lock washer B 5	1			
39	Ignition coil	1			
40	Air flow sensor	1			
41	Connector duct	1			
42	Throttle housing	1			

No.	Description	Qty.	Note When:		Special Instructions
			Removing	Installing	
43	Bolt M 4 x 10	2			
44	Washer A 4	2			
45	Throttle switch	1		Switching point < 1° throttle angle	
46	Temperature sensor	1		Torque: 12 – 15 Nm (9 – 11 ft lb)	
47	Seal	1			
48	Cover	1			
49	Fuel line (feed)	1			
50	Line	1			
51	Fuel line (return)	1			
52	Bolt M 6 x 12	2			
53	Washer A 6.4	2			
54	Fuel collecting pipe	1			
55	Fuel injector	4			
56	Capnut	1		Torque: 22 Nm (16 ft lb)	
57	Sealing ball	1			
58	Nut M 16	2			
59	Washer A 16	2			
60	Fuel pressure damper	1			
61	Pressure regulator	1			
62	Ignition cable holder	2			
63	Oxygen sensor	1		Torque: 50 – 60 Nm (36 – 43 ft lb)	

REMOVING AND INSTALLING SPEED AND REFERENCE MARK SENSORS

Removing

1. Disconnect plugs.

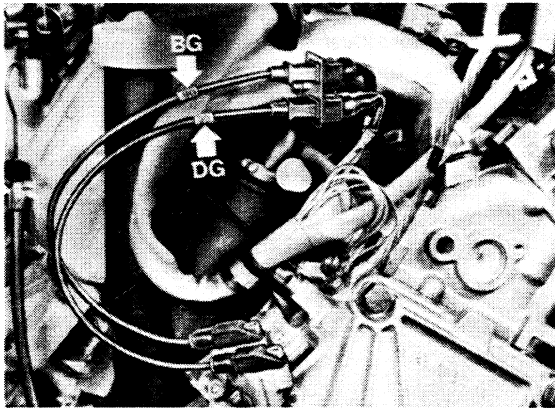

DG = SPEED SENSOR
BG = REFERENCE MARK SENSOR

2. Unscrew bolt and pull out sensor while turning back and forth at same time.

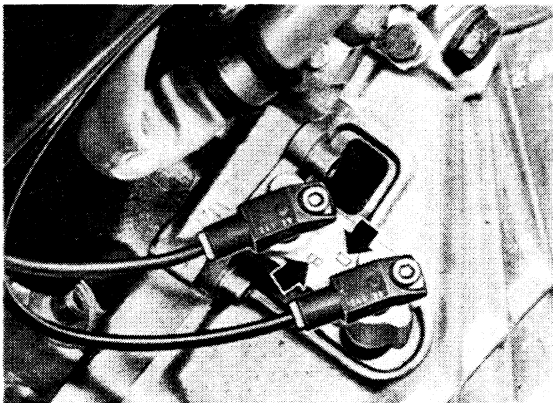

D = SPEED SENSOR
B = REFERENCE MARK SENSOR

Installing

Note

Sensors have permanent magnets. Make sure that sensors do not have any metal parts stuck on them before installation.

1. Check codes on sensors. Never use force when installing.
2. Tighten sensors. Tightening torque:
8 Nm (6 ft lb).
3. Check marks when connecting sensors.

Adjusting Clearance on Speed and Reference Mark Sensors

Note

A clearance of 0.8 mm is specified between the speed sensor and ring gear. If this clearance is correct, the reference mark sensor will be positioned correctly automatically.

The reference mark sensor clearance will only have to be adjusted in the case of damage or replacement of the locked reference mark screw (see Group 13).

Adjusting with Engine Removed

1. Bolt speed sensor on bracket.
2. Unscrew bolts on bracket. Adjust clearance between gear ring and speed sensor with a 0.8 mm feeler gauge blade.

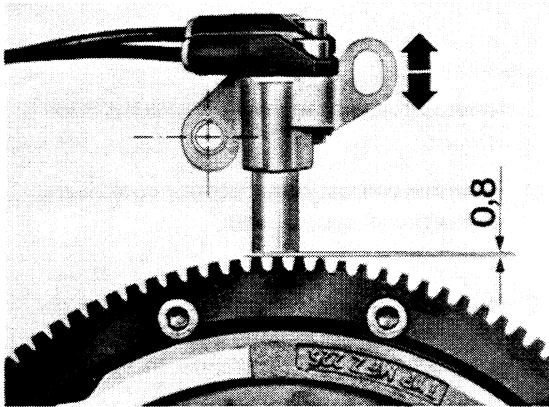

3. Loosen bolts on bracket and tighten again finger tight so that bracket can still be pivoted at bottom bolt.
4. Install longer sensor in speed sensor opening and tighten.
5. Move bracket with long sensor against stop (gear ring) and then tighten bracket bolts.
6. Remove longer sensor. If car's sensor was used, pry off glued washer carefully and remove remainders of glue.
7. Install speed sensor. Tightening torque: 8 Nm (6 ft lb).

Adjusting with Engine Installed

1. Remove speed sensor.
2. If available, a defective sensor could be used as an adjusting tool. Then paste a 0.8 mm thick washer (for clearance) on sensor with a suitable quick-drying glue. The car's sensor could also be used when work is performed carefully. The adhesive surface should then be kept as small as possible or an easily removable glue should be used.

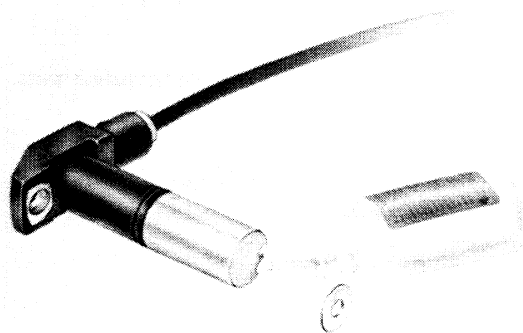

TROUBLESHOOTING DME

Testers and Tools

- Engine tester with oscilloscope, e. g. SUN 1010 or 1080, Bosch Mot 002.01
- Multiple tester (internal resistance at least 20 k-ohm/V).
- Adapter lead (Bosch "L-Jetronic" No. 1684 463 093).
- Pressure gage P 378 or VW 1318.
- Two locally made electric leads for tests on multiple pin plug of DME control unit and on plug connections with the same female plug version (timer contacts).

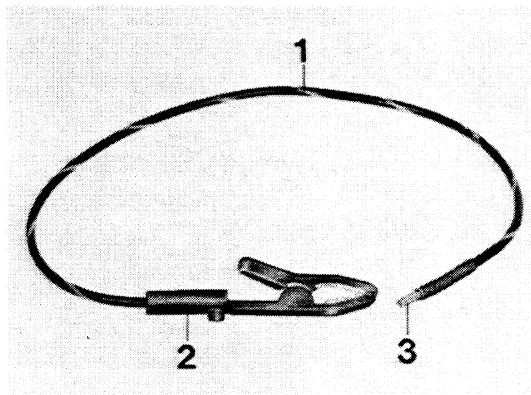

- 1 Highly flexible line approx. 50 cm (20 in.) long
- 2 Insulated lead clip (standard)
- 3 Flat male plug 2.8 (N 17.457.2)

Note:

Conform with the following safety measures to avoid damage on DME system.

1. Never start engine without a connected battery.
2. Reversing connections at battery could lead to destruction of control unit.
3. Never start engine with a quick charger. Only use a different 12 V battery to help starting.
4. Disconnect battery before quick charging.
5. Never disconnect battery while engine is running.
6. Disconnect or connect multiple-pin plug on control unit only when ignition is off.
7. The ground wire between engine and body must be connected before starting engine, e. g. after reinstalling engine, since otherwise DME control unit would be destroyed.
8. Disconnect multiple-pin plug on DME control unit before welding (electric welding).
9. Pull off fuel pump relay for compression tests.

Also refer to page 28 - 3 for information on dangers when working on electronic ignition systems.

INSTALLATION OF DME COMPONENTS

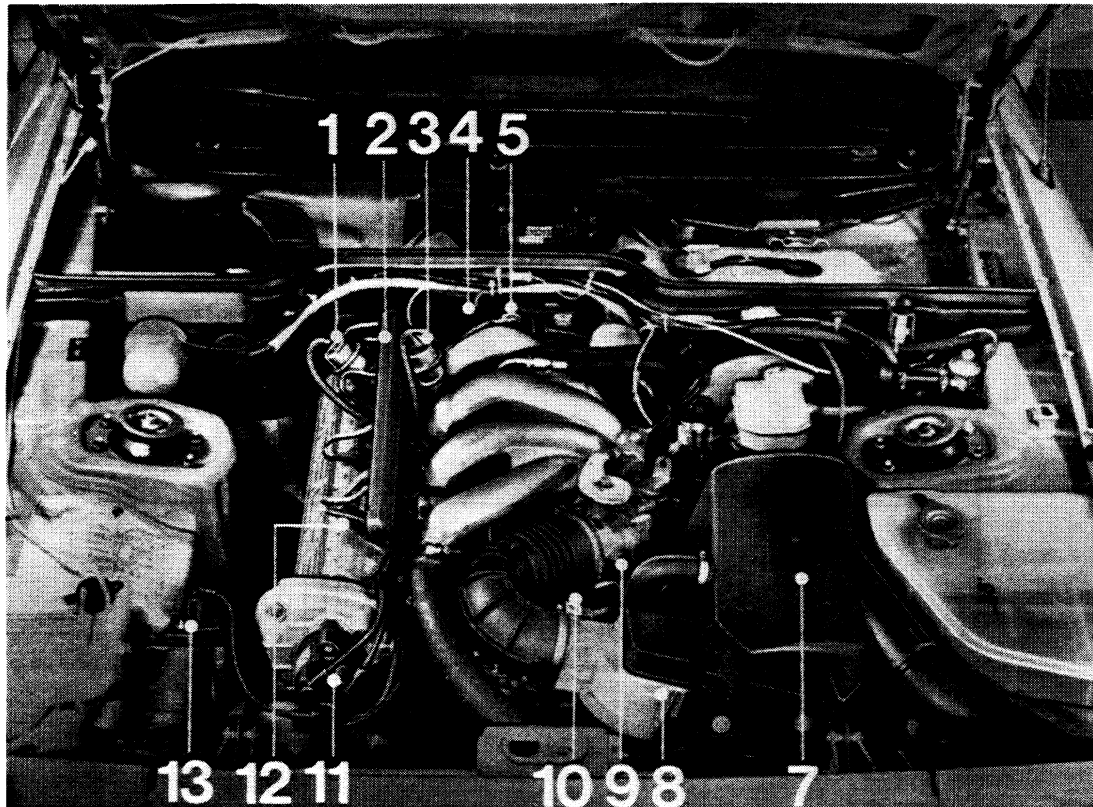

1. Pressure regulator
2. Fuel distributor
3. Diaphragm damper
4. Ground terminals for DME
5. Speed and reference mark transmitters
6. Control unit (in passenger compartment)
7. Air cleaner
8. Air flow sensor
9. Throttle switch
10. Temperature sensor II (engine temperature)
11. High voltage distributor
12. Fuel injectors
13. Ignition coil

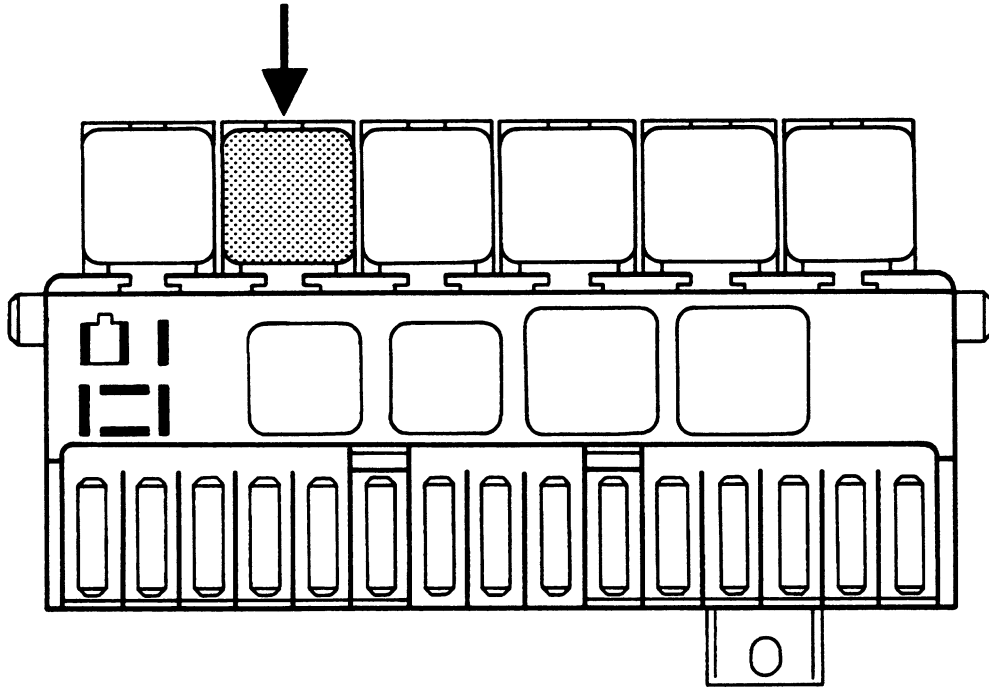

Relay for Fuel Pump and Power Supply – DME

DME PLUG CONNECTIONS

Top View of 35 Pin Plug
Disconnected on DME
Control Unit

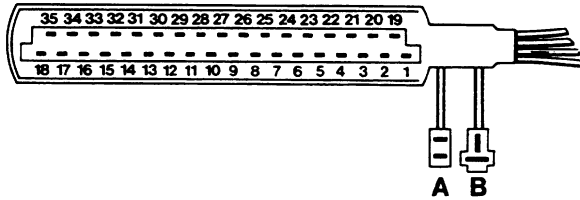

- A – Plug conn. for speed sensor
- B – Plug conn. for altitude box

Top View of Plug
Disconnected on Throttle
Switch

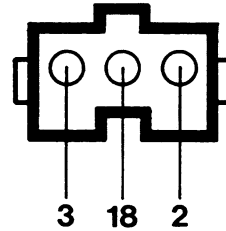

- Term. 2 – Idle contact
- Term. 3 – Full throttle contact
- Term. 18 – Ground

Top View of Plug Connections
for Pulse Transmitters

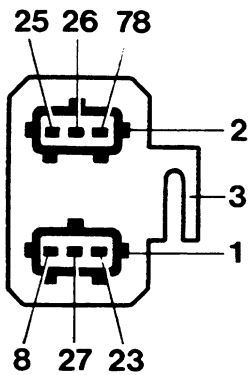

- 1 – Speed transmitter (DG)
- 2 – Reference mark transmitter (BG)
- 3 – Holder

Top View of Plug Disconnected
on Air Flow Sensor

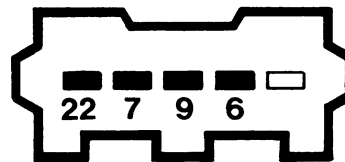

Top View of 9 Pin Round Plug
Receptacle
(Above Brake Booster)

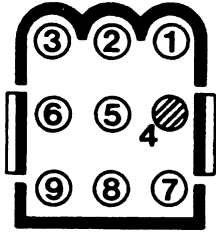

Note :

The fuel pump can be run by connecting battery on terminal 4 of the 9-pin plug.

TEST CONDITIONS	POSSIBLE CAUSES OF DEFECTS														
	1	2	3	4	5	6	7	8	9	10	11	12	13	14	15
Engine in good running condition, battery charged															
See Test Point															
POSSIBLE DEFECTS (Customer Complaints)															
Engine will not or is hard to start	X	X	X	X	X	X	X	X	X						
Poor idling	X		X		X	X		X	X						
Poor pick-up					X	X				X					
Misfiring	X				X	X									X
High fuel consumption					X	X			X			X			
Insufficient power	X				X	X				X				X	
	X — Check with a suitable tester!														

Note:

The test points should be performed in the given sequence, especially when the customer complaint concerns an engine which cannot be started or is hard to start.

TEST POINT 1**Checking Ground and Plug Connections**

1. Check both ground connections next to pulse transmitters for cleanliness and firm contact.

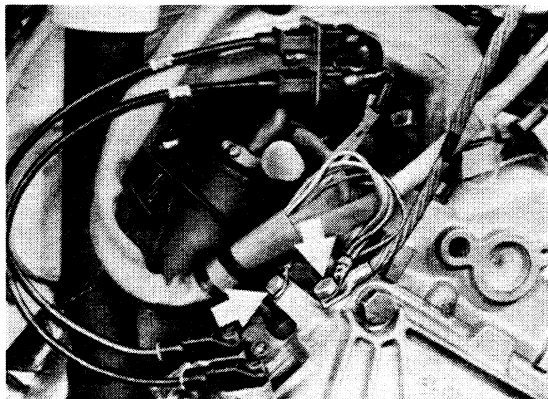

2. Check ground connection between engine and body.

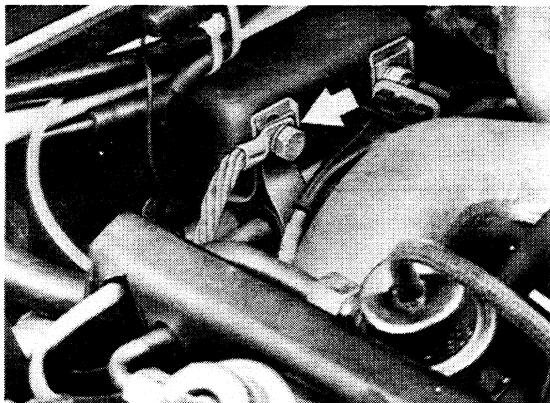

3. Check plug connections listed below carefully for tight fit, bent plug sleeves and corrosion.

- 3.1 Plug connection for DME control unit.
To remove, push catch toward right side and at same time take off plug forward.

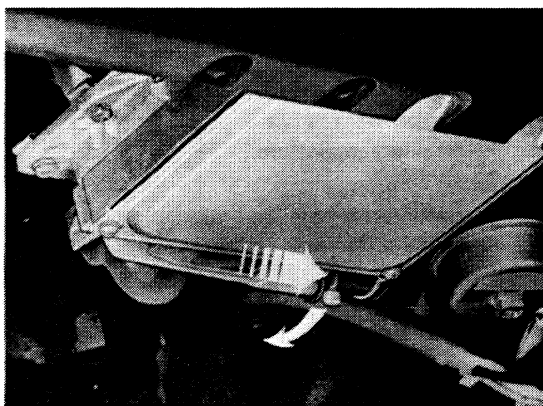

- 3.2 Plug connection for speed and reference mark transmitters (check codes).

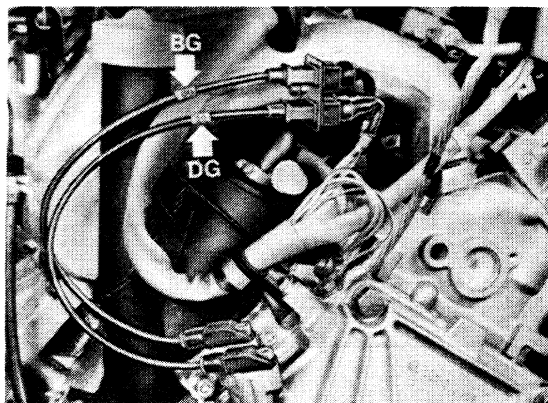

3.3 Plug connection for air flow sensor.



3.6 Plug connection for fuel injectors.

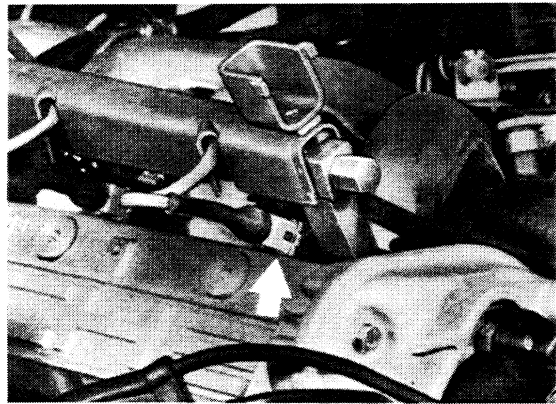

3.4 Plug connection for throttle switch.

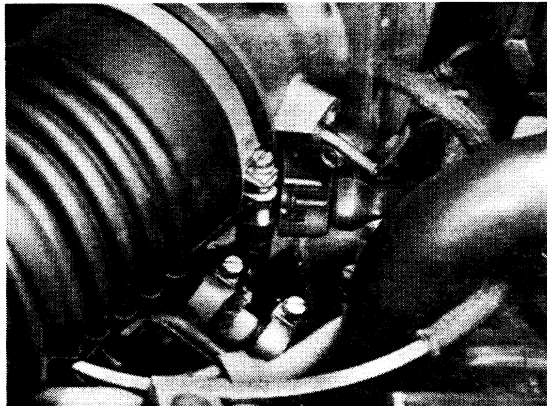

3.7 Plug connection above brake booster.

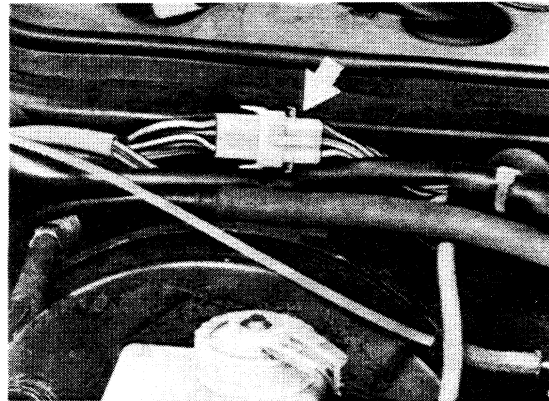

3.5 Plug connection for temperature sensor II (engine temperature).

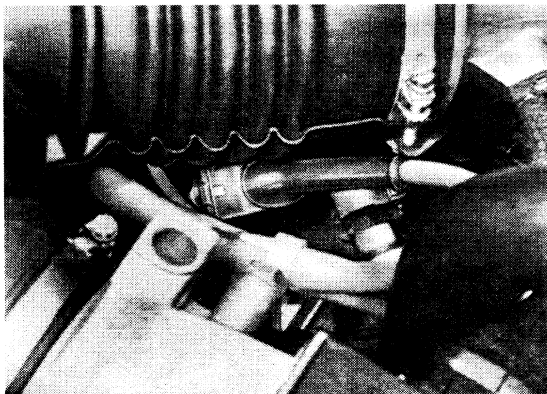

3.8 Relay socket of fuel pump relay.

Note :

Frequent removal and installation of the relay could loosen and push back the catch for flat female plugs.

TEST POINT 2

Power Supply for DME Control Unit and Fuel Pump

2. Fuel Pump

1. DME Control Unit

Check the following points, if for example the fuel pump does not run while starting the engine.

1.1 Turn off ignition and pull off multiple pin plug on DME control unit.

2.1 Check fuse 2 (16 amps) in auxiliary fuse box.

1.2 Turn on ignition.

2.2 Check fuel pump relay.

1.3 Measure voltage between term. 35 and term. 5 as well as between term. 18 and term. 5.

2.3 Supply battery voltage to term. 4 of 9-pin plug connection above brake booster, or bridge term. 30 and 87 b on socket of fuel pump relay.
Fuel pump should then run.

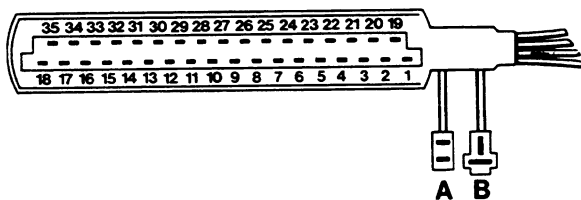

TEST POINT 3

Note:

An oscilloscope should be used to check the speed and reference mark transmitters.

Specification: battery voltage.

(Always use extra wires to connect tester.)

If voltage deviates from specified value, check fuel pump relay, 9-pin plug connection above brake booster (term. 2 and term. 3) and corresponding wires.

Speed Transmitter

1.4 Turn off ignition and connect multiple pin plug on DME control unit.

1. Turn off ignition and pull off multiple pin plug on DME control unit.

2. Connect and adjust oscilloscope.

SUN 1010	SUN 1080	BOSCH MOT 002.01
Cylinder selector switch set to 2	to 2	Range selector switch set to "special" pos.
Engine cylinder switch set to 4-stroke	to 4-stroke	Special wire connected on test terminals off DME control unit with help of auxiliary wire
Voltage selector switch for image screen scale set to 50 V	to 25 V	Screen control lever moved against left stop
Ignition coil polarity switch set to +	to +	
Image selector switch set to parade	Image selector switch superimposed or set to parade; program switch set to pos. 2 to 5 (never to 1)	

Connect blue connection via locally made auxiliary wire on term. 8 and black connection on term. 27 of DME plug.

If the transmitter signal is less than 2.5 V, check distance between starter gear ring and transmitter.

Specification: 0.8 ± 0.05 mm (see page 28 - 14 in Repair Manual).

3. Start engine.

Sine oscillation, the amplitude of which must be more than 2.5 V from peak to peak, must be displayed on the screen.

If a transmitter signal is not displayed in spite of correct connection and correct adjustment of tester, measure power flow and insulation of speed transmitter.

Coil resistance term. 8 against term. 27.
Specification: 0.6 to 1.6 k-ohm.

Insulation resistance term. 8 against term. 5.
Specification: more than 1 M-ohm.

Replace speed transmitter, if necessary.

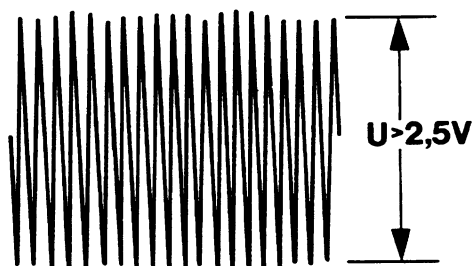

TEST POINT 4

Reference Mark Transmitter

Adjust oscilloscope as described in point 3.
(If using SUN 1080, press one of "ignition coil test"
buttons for a better picture.)

If there is no transmitter signal, proceed as
described in test point 3 for speed transmitter.
The same specifications are applicable.

Connect blue connection via locally made wire on term.
25 and black connection on term. 26 of DME plug.

If using Bosch tester, connect red clip of special lead
on term. 25.

Start Engine

A single sine oscillation should be displayed on the
screen. It is important that the oscillation begins
with a positive slope and more than 2 V is
displayed on the screen scale with a starter speed of
at least 200 rpm (the signal amplitude depends on
the starter speed).

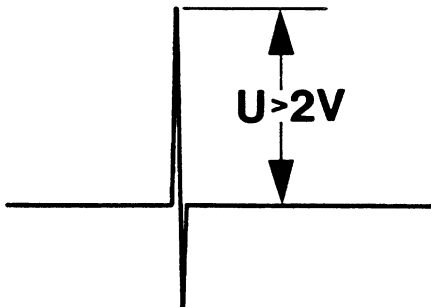

If the transmitter signal is less than 2 V, check
distance between transmitter and reference mark.

Specification: 0.8 ± 0.05 mm (see page 28 - 14 in
Repair Manual).

TEST POINT 5

Ignition System

1. Adjust secondary image on oscilloscope:
term. 1 and term. 15, trigger clip on cylinder
no. 1.

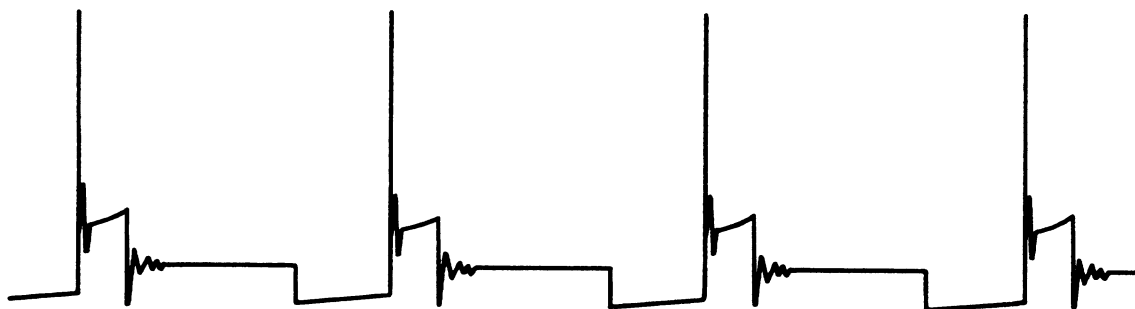

Note :

If a defect is displayed for all cylinders, it will be in the primary or secondary circuit from the ignition coil to the distributor rotor. If a defect is displayed for only one cylinder, it will be after the distributor rotor.

2. Check distributor cap for damage, burnt spots and dirt.
Retaining hooks must engage firmly when installing.
3. Check distributor rotor.
Shielded resistance: 1 k-ohm.
Check visually for tight fit, damage and dirt.
4. Check spark plug caps and leads for damage or traces of burning.
Shielded resistance: 3 k-ohm.
5. Check ignition coil.
Primary resistance:
term. 1 against 15 = 0.4 – 0.6 ohm.
Secondary resistance:
term. 1 against 4 = 5 – 7.2 k-ohms.
Check visually for damage or burnt spots.

Note :

Avoid checking the ignition system via the spark gap by pulling off the spark plug caps. This could cause destruction of the ignition coil and control unit.

6. Check ignition timing at idle speed and with engine having operating temperature.
Ignition timing at 800 + 50 rpm = 5 to 15° before TDC.

TEST POINT 6

Air Flow Sensor

1. Push back protective sleeve of the air flow sensor connector. The connector remains attached. Connect voltmeter to terminal 9 and to terminal 6 on the rear of the connector.

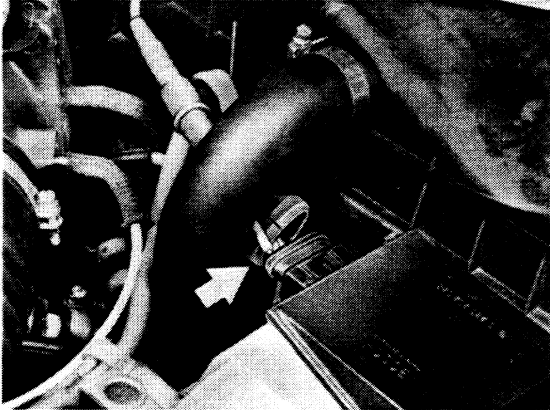

Specification: more than 8 V.

2. Remove air cleaner.
Connect voltmeter between term. 7 and ground.

Specification: approx. 150 to 250 mV.

3. Push sensor plate to full throttle position with a not-to-hard, smooth item inserted through the filter intake opening.
Voltage rises above 8 V with sensor plate fully open (switch over test range).
The sensor plate must not stick and return to off position on its own when released.

4. Check temperature sensor I (intake air temperature). Turn off ignition and pull off plug on air flow sensor. Connect ohmmeter between term. 6 and 22 on air flow sensor (both outer flat male plugs).

Specification at 15 to 30° C: 1.45 - 3.3 k-ohms.

Note

Interruption on temperature sensor causes richer mixture.
Short on temperature sensor causes leaner mixture.

TEST POINT 7

Fuel Pressure

1. Open flap on distribution tube.
Unscrew capped nut on test connection.

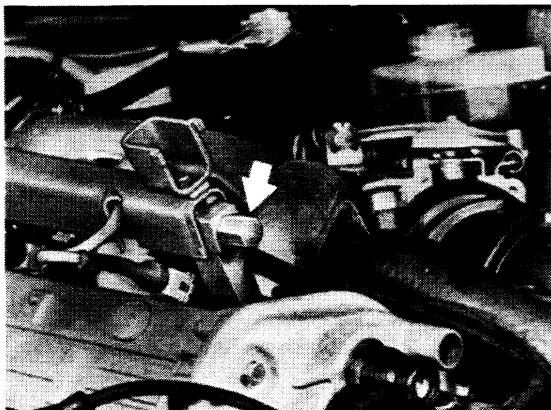

Note :

Be careful that sealing ball does not fall out when removing the capped nut.
Catch escaping fuel.
Electric sparks could cause fire!

2. Connect pressure tester P 378 on distribution tube.

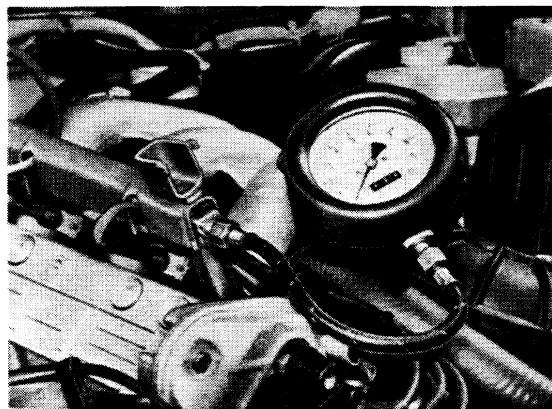

3. Start engine and measure fuel pressure at idle speed.

Specification: approx. 2.0 bar (29 psi).

4. Pull off vacuum hose on pressure regulator.
Fuel pressure should rise.

Specification: 2.3 to 2.7 bar (33 to 39 psi).

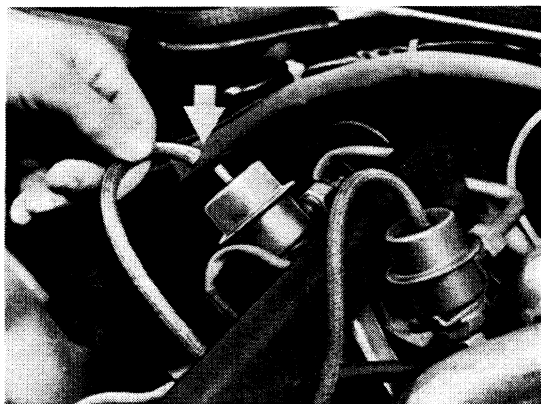

5. If fuel pressure deviates from specified values,
pinch return line shut slowly with a clamp.

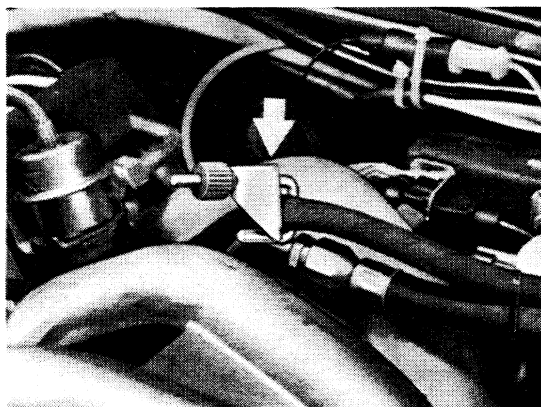

Replace pressure regulator if pressure rises above 4 bar (58 psi).

If pressure remains below 4 bar (58 psi), check fuel filter or replace fuel pump.

If engine does not run, supply battery voltage to term. 4 of 9-pin plug or bridge terminals 30 and 87 b on socket of fuel pump relay.

Fuel pump should run.

Specification: 2.3 to 2.7 bar (33 to 39 psi).

Tightening torque for capped nut:
22 Nm (16 ft lb).

TEST POINT 8

Fuel Injectors and Injection Timing

1. Checking Fuel Injectors

If engine can be run, disconnect plugs on injectors separately.

If injectors are okay, the engine speed will drop each time.

If engine cannot be run, measure voltage on one plug connection of injectors against ground.

One of both terminals must have battery voltage; if necessary perform test point 2.

Measure coil resistance on flat male plugs of fuel injector.

Specification: 2 to 3 ohms.

2. Checking Injection Timing

Adjust oscilloscope as described in test point 3.

Connect adapter lead (Bosch "L-Jetronic", No. 1684 463 093) between one fuel injector and its matching plug.

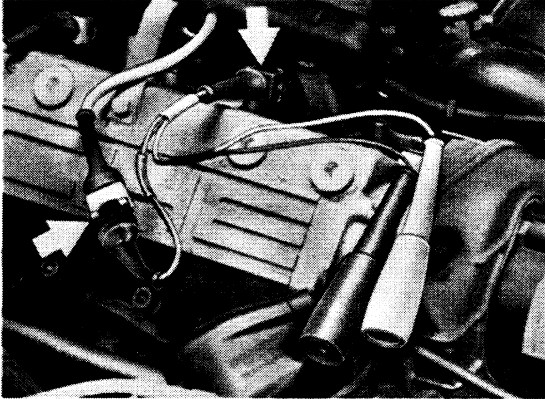

SUN 1010: Blue tester lead on red Bosch lead.
Black tester lead on black Bosch lead.
Ignition coil polarity set to – and trigger clip connected on term. 4.

C a u t i o n ! Never let connections contact ground.

Make following connections if idle speed drops after making above connections or engine stops.

Blue tester lead on black Bosch lead.
Black tester lead **n o t** connected on red Bosch lead!

C a u t i o n ! Never let connections contact ground.

SUN 1080: Green tester lead (15) on red Bosch lead.
Blue tester lead (1) connected on black Bosch lead.

BOSCH: Special red lead on black Bosch lead.
Special black lead and red Bosch lead **n o t** connected.
Tester lead for ignition coil connected on term. 1 and 15 of ignition coil.

C a u t i o n ! Never let connections contact ground.

Start engine. The following oscillographs will be displayed on the oscilloscope when injection timing is correct.

STARTER SPEED

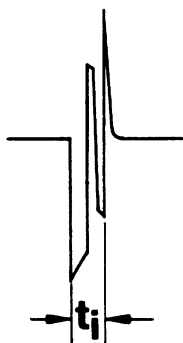

t_i = Injection time

IDLE SPEED

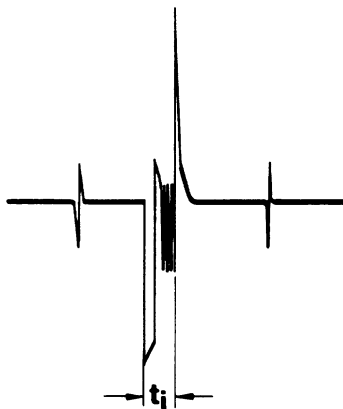

ACCELERATION

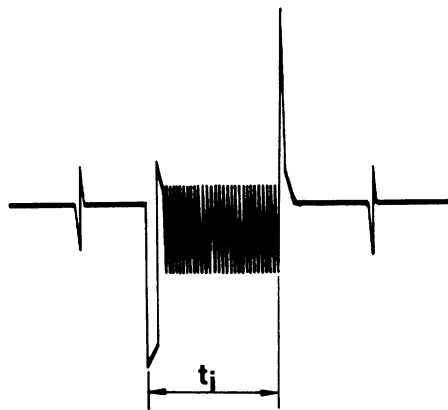

DECELERATION
(coasting)



Refer to test point 10 if injection signal does not switch off while decelerating.

TEST POINT 9

Temperature Sensor II
(Engine Temperature)

1. Check plug for tight fit and plug receptacles for cleanliness and contact.

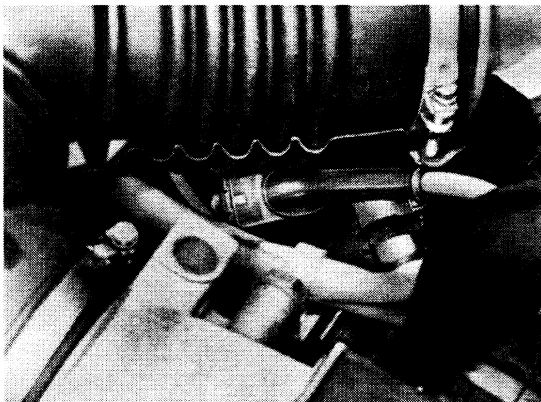

2. Connect ohmmeter between term. 13 on disconnected DME plug and ground.

Specifications for 15 to 30 °C (59 to 86 °F):
1.45 to 3.3 k-ohms

Specifications for 80 °C (176 °F):
280 to 360 ohms

If measured values deviate from specified values, repeat test on temperature sensor itself, replacing temperature sensor if necessary.

Note:

Break on temperature sensor causes richer mixture.

Short on temperature sensor causes leaner mixture.

TEST POINT 10

Throttle Switch

1. Connect ohmmeter between term. 2 on DME plug and ground.

Specifications with
throttle closed: zero ohm
throttle open: infinite ohms

Switching over must take place even when throttle is only slightly open (approx. 1°).

2. Connect ohmmeter between term. 3 of DME plug and ground.

Specification with throttle closed:
infinite ohms.

Specification with throttle wide open:
zero ohm.

Switching must take place immediately before full throttle.

If switching points are not correct, repeat test direct on throttle switch by connecting ohmmeter term. 18 (ground; center flat plug on throttle switch) and term. 2 or term. 3.

Adjusting Throttle Switch

1. Remove throttle housing.
2. Unscrew throttle switch mounting screws.

3. Hold throttle in closed position. Turn switch until inner stop is felt. Throttle must not be moved.

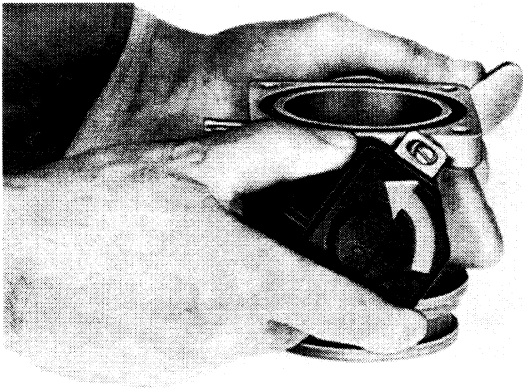

Check Full Throttle Enrichment

1. Start engine and run at idle speed.
2. Connect term. 3 (full throttle contact) and term. 18 on disconnected plug. Engine speed should drop.

4. Tighten switch mounting screws.
Throttle must rest firmly on stop screw.

Checking Coasting Shut-off (Stopping of Injection Signal)

1. Pull off plug on throttle switch.
2. Connect term. 2 (idle contact) and term. 18 on disconnected plug with an auxiliary lead. This will simulate a closed throttle for the DME control unit. (Only use suitable flat plugs on auxiliary lead.)
3. Start engine and increase speed to about 1600 rpm. Engine should begin to surge, i. e. the injection signal will be stopped above 1600 rpm.

TEST POINT 11

Cold Start Enrichment

Connect and adjust oscilloscope as described in test point 8 (injection timing).

Start Engine

The signal displayed on the oscilloscope must be spread, but return immediately to the idle signal.

Note:

The spread signal will be very significant and only visible briefly while starting the engine.

ENRICHMENT

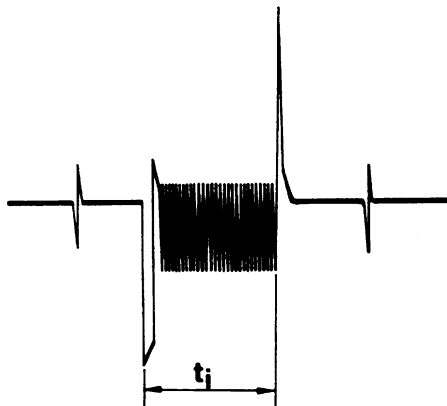

IDLE



TEST POINT 12

CO and idle speed adjustments (see Repair Manual from page 25 - 7 on).

TEST POINT 13

Auxiliary Air Regulator

1. A hot auxiliary air regulator will be closed. Pinch air hose = engine speed should only drop slightly.

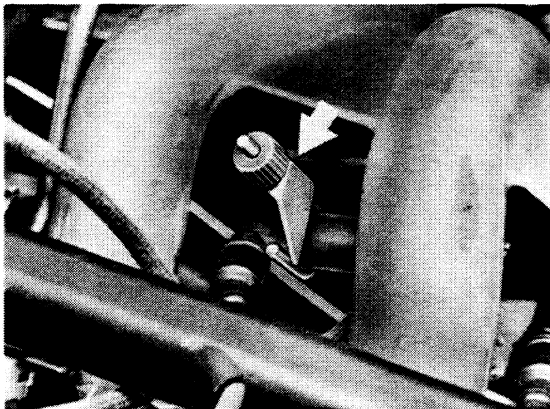

2. Pull off plug on auxiliary air regulator and measure voltage between both plug receptacles. Plug must have battery voltage.
3. Measure resistance on auxiliary air regulator with an ohmmeter.

Specification: 30 to 65 ohms
(20 to 55 ohms since 8.82)

TEST POINT 14

Leaks in Intake System

1. Check all hoses and connections after air flow sensor for tight fit and leaks.
2. Tighten hose clamps.

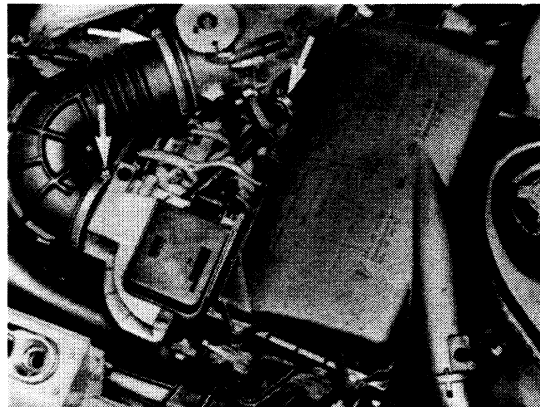

TEST POINT 15

Alternator and Regulator

Peak voltage of the alternator could trigger off engine misfiring.

1. Remove drive belt and alternator.
2. Start engine. If defect is eliminated, check alternator and regulator.

TESTING LAMBDA SENSOR OPERATION

(Short test)

Prerequisites:

- Engine at operating temperature
- Idle speed correctly set

1. Connect exhaust tester at bleed nozzle in engine compartment.

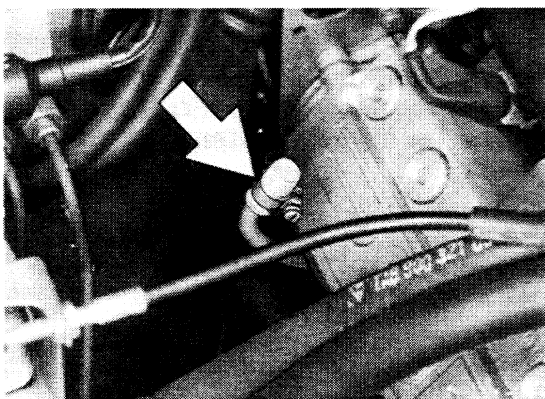

2. Detach lambda sensor plug connection, wait for thermal equilibrium, and no CO value.

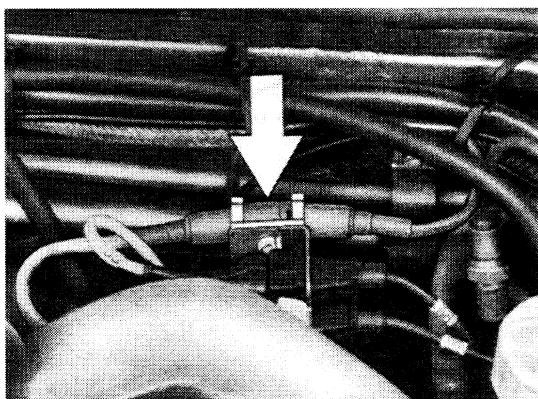

3. Pull off negative pressure line from fuel pressure regulator and close with suitable plug.

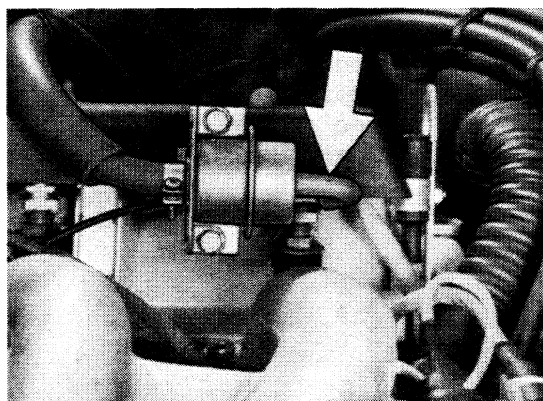

The CO value should rise significantly.

4. Reconnect plug on lambda sensor. The CO value should adjust itself to the control value of $0.6 \pm 0.2\%$.

If there is no change in the CO level, there is a defect in the lambda sensor or in the DEE control unit.

TESTING DEE CONTROL UNIT

(Lamba Control Function)

1. Same prerequisites as for "Testing Lambda Sensor Operation".
2. Disconnect lambda sensor plug. Briefly connect term. 1 on the plug half to the control unit to ground with an auxiliary lead.

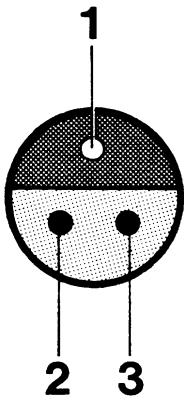

The CO value should rise.

If there is no change in the CO level, check connection to DEE control unit (term. 24 green) and if necessary, replace control unit.

TESTING LAMBDA SENSOR

(Sensor Voltage)

1. Prerequisites as for "Testing Lambda Sensor Operation".
2. Disconnect lambda sensor plug.
3. Clip voltmeter to term. 1 (plug half to sensor) and to ground.
4. The voltage should lie in the range from 0.1 V to 1.0 V (depending on oxygen content in exhaust).

Lambda sensor voltage characteristic for working temperature of 600° C.

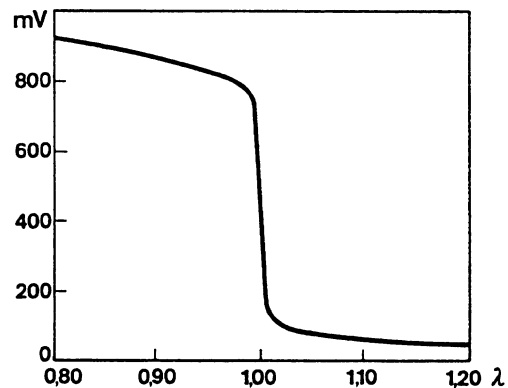

rich mixture (insufficient air) lean mixture (excess air)

REMOVING AND INSTALLING DEE CONTROL
UNIT IN MODELS AS OF 85/2

1. Fold back mat in passenger's
side footwell. Unscrew and remove
footwell cover.

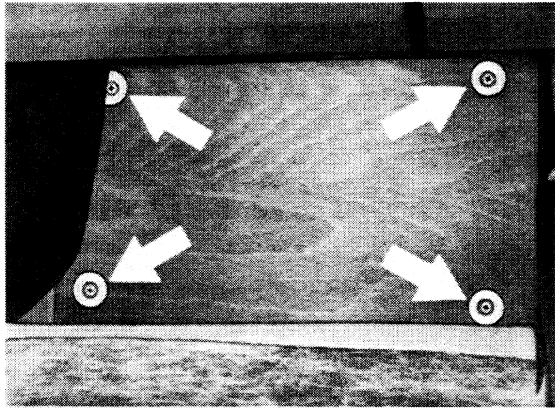

3. Unlock and pull out
control unit plug.

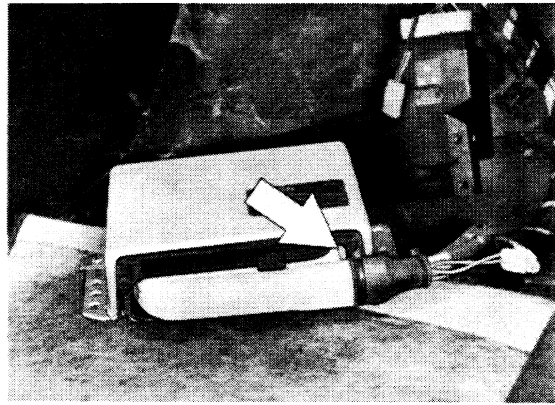

2. Unscrew control unit bracket
and DEE control unit.

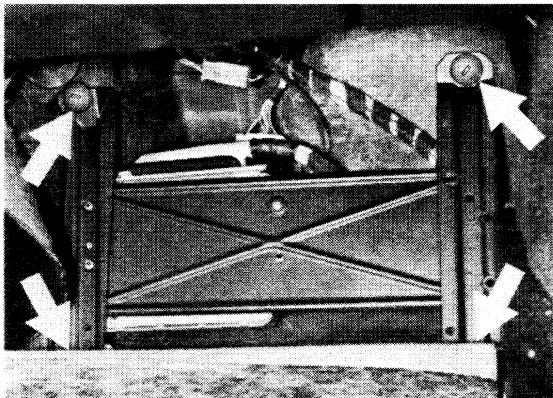

DME CONTROL UNIT CODING, 924 S '86 MODELS ONWARD

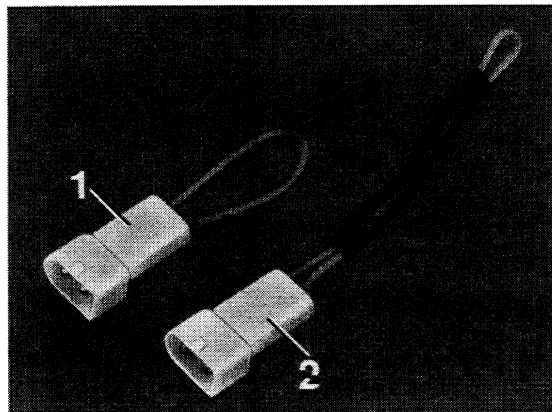
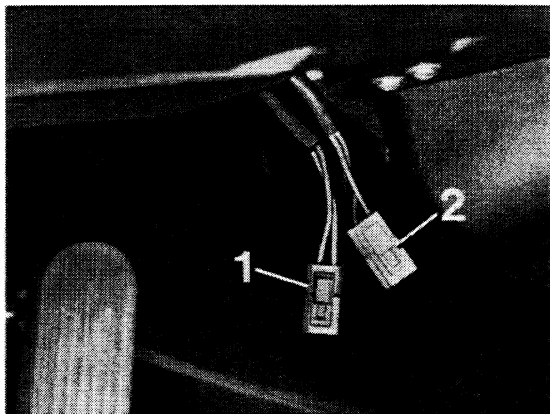

1 - Plug for characteristic-map switch
2 - Plug for variant switch

1 - 944.612.525.01
2 - 944.612.421.00

Country	DME Control Unit	Impedance Adapter 944.612.421.00	Coding plug 944.612.525.01
Rest of world	944.618.121.04	X	-
Sweden, Switzerland	944.618.121.04	X	X
Rest of world "stage A"	944.618.121.04	X	X
M298	944.618.121.04	-	-
USA/Canada/ California/ Japan	944.618.121.04	-	X

Connect coding plug (1) to plug 1 of wire harness.

Connect impedance adapter (2) to plug 2 of wire harness.

See Technical Information Gr.2 No. 5/85 dated 11 August, 1986

DME CONTROL UNIT CODING, 944 '85/2 MODELS ONWARD

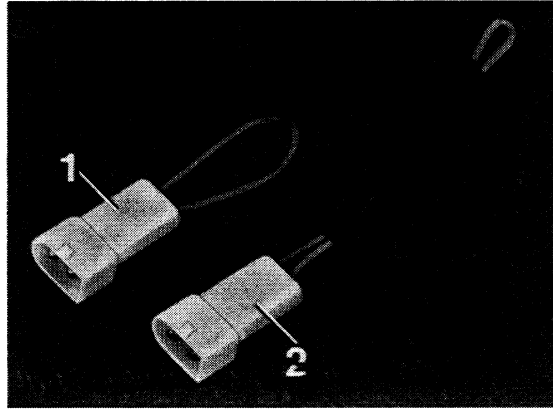
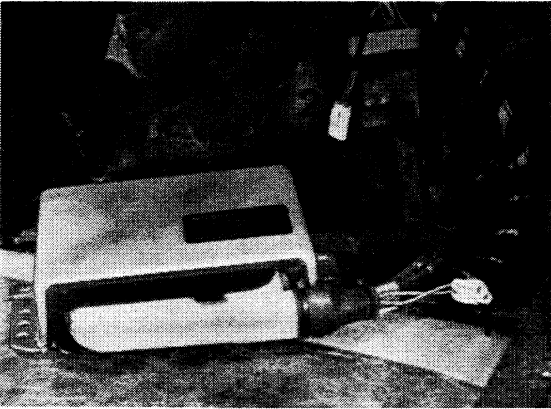

1 - Plug for characteristic-map switch
2 - Plug for variant switch

1 - 944.612.525.01
2 - 944.612.421.00

Country	DME Control Unit	Impedance Adapter 944.612.421.00	Coding plug 944.612.525.01
Rest of world	944.618.121.03	X	-
Sweden, Switzerland	944.618.121.03	X	X
Rest of world "stage A"	944.618.121.03	X	X
USA/Canada/ Australia M 298	944.618.121.04	-	-
California/ Japan	944.618.121.04	-	X

Connect coding plug (1) to plug 1 of wire harness.

Connect impedance adapter (2) to plug 2 of wire harness.

See Technical Information Gr.2 No. 1/86 dated 20 March, 1986 and Technical Information Gr.2 No. 5/85 dated 11 August, 1986

DME control unit coding 944 2.7 I

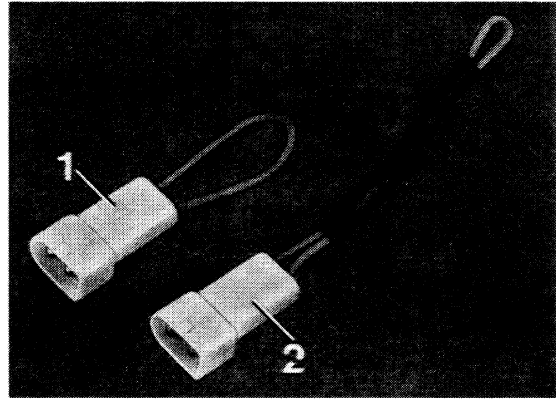
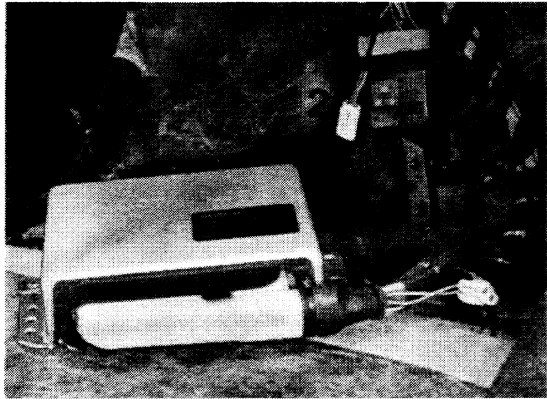

1- Connector for the performance
characteristic switch
2- connector for the variant switch

4404

1 - 944.612.525.01
2 - 944.612.421.00

85/499

Country	Resistance adapter 944.612.421.00	Coding connector 944.612.525.01
California, Japan with catalytic converter	—	X
R.o.w. with cat. converter		—
R.o.w. without cat. converter		—
If required, (91 RON lead-free) with catalytic converter	X	X

The coding connector (1) is plugged on to connector 1 in the cableharness.

The resistance adapter (2) is plugged on to connector 2 in the cableharness.

DME CONTROL UNIT CODING, 944 TURBO, '85 MODELS ONWARD

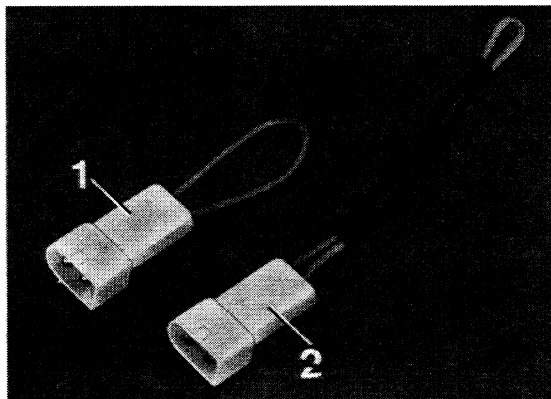

1 - Plug for characteristic-map switch
2 - Plug for variant switch

1 - 944.612.525.01
2 - 944.612.421.00

Country	DME Control Unit	Impedance Adapter 944.612.421.00	Coding plug 944.612.525.01
Rest of world	951.618.121.02	X	-
Sweden, Switzerland	951.618.121.02	X	X
USA/Canada/ Australia M 298	951.618.121.02	-	-
California/ Japan	951.618.121.02	-	X

Connect coding plug (1) to plug 1 of wire harness.

Connect impedance adapter (2) to plug 2 of wire harness.

See Technical Information Gr.2 No. 5/85 dated 11 August, 1987

CODING OF DEE CONTROL UNITS, 924 S, '88 MODELS ONWARD

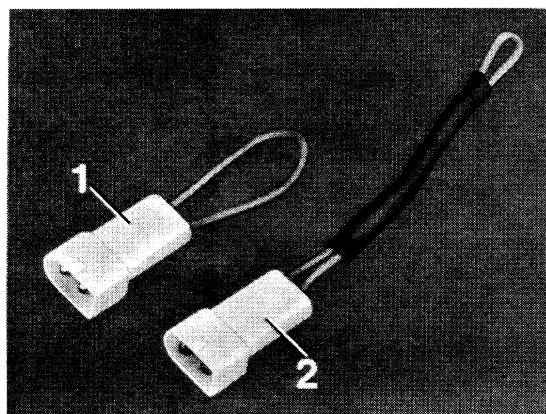
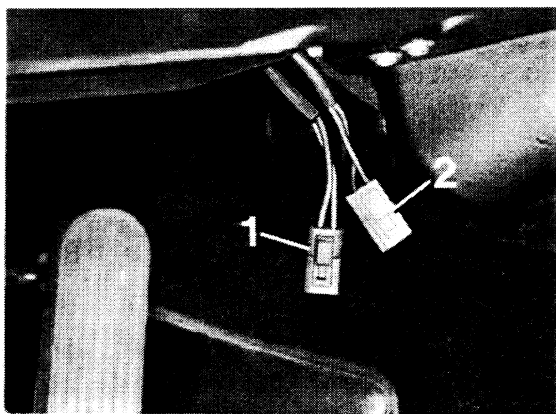

1 - Plug for characteristic-map switch
2 - Plug for variant switch

1 - 944.612.525.01
2 - 944.612.421.00

Country	DEE Control Unit	Impedance Adapter 944.612.421.00	Coding Plug 944.612.525.01
USA	944.618.121.05	-	-
RoW with cat. converter	944.618.121.05	-	-
RoW without cat.converter*	944.618.121.05	X	-
California, Japan	944.618.121.05	-	X
Australia	944.618.121.05	X	X

* In cars without catalytic converters, ensure that cable link 911.612.422.00 is inserted in the wire harness instead of the oxygen sensor. This protects the DEE control unit from scatter.

CODING OF DEE CONTROL UNITS, 944, '88 MODELS ONWARD

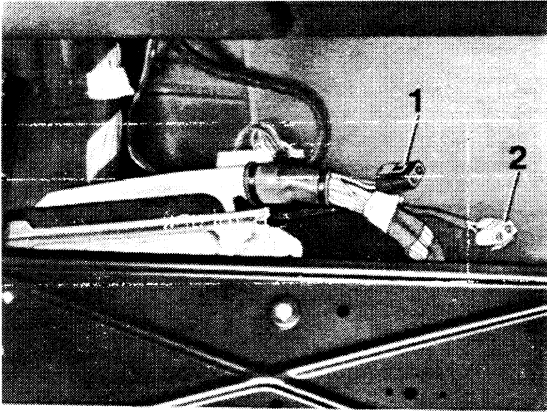

1 - Plug for characteristic-map switch
2 - Plug for variant switch

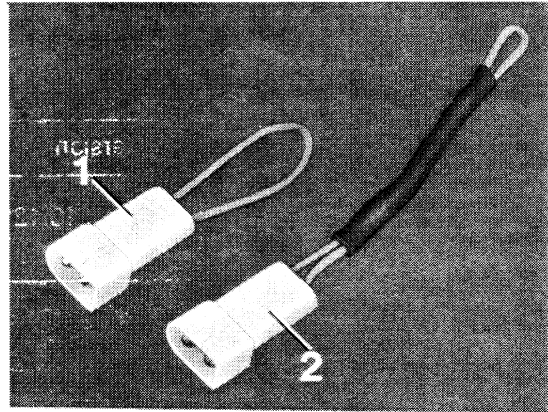

1 - 944.612.525.01
2 - 944.612.421.00

Country	DEE-Control Unit	Impedance Adapter 944.612.421.00	Coding Plug 944.612.525.01
USA	944.618.121.05	-	-
RoW with cat. converter	944.618.121.05	-	-
RoW without cat.converter*	944.618.121.05	X	-
California, Japan	944.618.121.05	-	X
Australia	944.618.121.05	X	X

* In cars without catalytic converters, ensure that cable link 911.612.422.00 is inserted in the wire harness instead of the oxygen sensor. This protects the DEE control unit from scatter.

Equipment Table**Engine type M 44.09/10**

Type/Model	Version	Remarks
924 S Mod. '88 944	944.618.121.05	DME control unit

Engine type M 44.11/12

Type/Model	Version	Remarks
944 Mod. '89	944.618.121.06	DME control unit